

Picture is for reference only

LEVEL 20 XT

User's Manual
Benutzerhandbuch
Mode d'emploi
Manual del usuario
Manuale dell'utente
Manual do Utilizador

安裝說明書
用戶手冊
ユーザーズマニュアル
Руководство пользователя
kullanıcı elkitabı
(EEE Yönetmeliğine Uygundur)
คู่มือการใส่



© 2018 Thermaltake Technology Co., Ltd. All Rights Reserved. A-2018.04
All other registered trademarks belong to their respective companies. www.thermaltake.com



TT Premium



TT Premium

To continue achieving the corporate mission of delivering the perfect user experience, Thermaltake developed "TT Premium" with the essence of combining supreme quality products with a new logo design. TT Premium is far more than just a guarantee of quality. Behind the name, it represents the passion in DIY, Modding and Thermaltake's desire to be the most innovative brand in the PC hardware market. To satisfy the demand of the high-end PC users, TT Premium follows its core values of Excellent Quality, Unique Design, Diverse Combinations and Boundless Creativity to provide a high performance PC product for every enthusiast. <http://tppremium.com>

Tt LCS-Liquid Cooling Support Certification



Tt LCS Certified is a Thermaltake exclusive certification applied to only products that pass the design and hardcore enthusiasts standards that a true LCS chassis should be held to. The Tt LCS certification was created so that we at Thermaltake can designate to all power users which chassis have been tested to be best compatible with extreme liquid cooling configurations to ensure you get the best performance from the best features and fitment.

Join Tt Community To Receive Benefits



Dear Valued Customer,

Thank you for choosing Thermaltake.

As a new user we value your thoughts and opinions and your feedback is important to us. We at Thermaltake would like to use this opportunity to invite you to join our Community Forums. Register today to start enjoying the full benefits of our community.



Benefits of being a member:

- Quick and responsive user support
- Receive help and advice with new builds
- Keep up to date with new product releases
- Share your thoughts and builds with the community
- Enter monthly contests and giveaways

Brand official website
<http://www.thermaltake.com/>

Global Facebook
<https://www.facebook.com/ThermaltakeInc>

Taiwan Facebook
<http://www.facebook.com/ThermaltakeTW>

Global community forums
<http://community.thermaltake.com>

CONTENTS

Chapter 1. Product Introduction

1.0	Specification	01
1.1	Accessory	01
1.2	Warning and Notice	02

Chapter 2. Installation Guide

2.0	Side Panels Disassembly	04
2.1	Power Supply Unit (PSU) Installation	05
2.2	Motherboard Installation	06
2.3	3.5" & 2.5" HDD Installation	07
2.4	PCI Card Installation	09
2.5	Air Cooling Installation	10
2.6	Liquid Cooling Installation	11
2.7	Bracket Installation	12













Chapter 3. Leads Installation Guide

3.0	Case LED connection	13
3.1	USB 3.0 connection	13
3.2	Audio connection	13
3.3	Thermaltake Power Supply Series (Optional)	19
3.4	Tt RGB Plus Ecosystem	20

Specification

Case Type	E-ATX Cube Case	
Dimension (H*W*D)	515 x 394 x 623 mm (20.3 x 15.5 x 24.5 inch)	
Side Panel	4 mm Tempered Glass x 4 (Left & Right & Front & Top)	
Cooling System	Rear (exhaust) : 140 x 140 x 25 mm fan (1000rpm, 16dBA)	
Drive Bays	6 x 3.5" or 2.5" (HDD Cage) 1 x 3.5", 2 x 2.5" (M/B Tray)	
Expansion Slots	8	
Motherboard	6.7" x 6.7" (Mini ITX), 9.6" x 9.6" (Micro ATX), 12" x 9.6" (ATX), 12" x 13" (Extend ATX)	
I/O Port	USB 2.0 x2, USB 3.0 x2, HD Audio x 1, Type-C x1	
Fan Support	Front: 3 x 120 mm, 2 x 140 mm, 2 x 200 mm Top: 8 x 120 mm, 6 x 140 mm, 2 x 200 mm Rear: 2 x 120 mm or 2 x 140 mm	Left / Right Side: 4 x 120 mm, 3 x 140 mm Bottom: 3 x 120 mm
Radiator Support	Front: 1 x 360 mm, 1 x 280 mm, 1x 360 mm (200 mm series) Top: 2 x 480 mm, 2 x 420 mm, 1 x 360 mm (200 mm series) Rear: 1 x 120 mm, 1 x 140 mm	Left / Right Side: 1 x 480 mm, 1 x 420 mm Bottom: 1 x 480 mm, 1 x 420 mm
Clearance	CPU cooler height limitation: 250 mm VGA length limitation: 590 mm PSU length limitation: 220 mm (With Bottom Fan)	

Accessory

Figure	Parts Name	Qty	Used for
	Screw # 6-32 x 6 mm	4	PSU
	Stand-off # 6-32 x 6 mm	4	Motherboard
	Screw M3 x 5 mm	13	Motherboard
	Nut Setter	1	Motherboard Stand-off
	Screw # 6-32 x 5 mm	10	3.5" HDD
	Screw M3 x 5 mm	28	2.5" HDD/SSD
	Screw Ø5 x 12 mm	4	Case Fan
	Screw # 6-32 x 32 mm	8	Case Fan
	Screw # 6-32 x 4 mm	2	Radiator Bracket
	Cable Ties	10	Cable Management
	Buzzer	1	Motherboard Alarm
	ODD Plate	1	Fan, Radiator

Warning and Notice

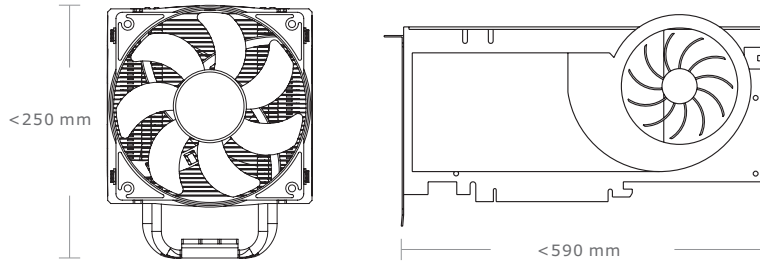

Warning!!

CPU Cooler Height Limitation:

Please ensure that your CPU cooler does NOT exceed 250 mm (9.8 inches) height.

VGA (Add-on card) Length Limitation:

Please ensure that your VGA (Add-on card) does NOT exceed 590 mm (23.2 inches) length.

Warnung!!

CPU-Kühler Höhenbeschränkung:

Bitte stellen Sie sicher, dass Ihr CPU-Kühler 250 mm (9,8 Zoll) Höhe nicht überschreitet.

VGA (Add-on-Karte) Längenbeschränkung:

Bitte stellen Sie sicher, dass Ihre VGA (Add-on-Karte) 590 mm (23,2 Zoll) Länge nicht überschreitet.

Avertissement !

Limite de hauteur du ventilateur de CPU :

Vérifiez que la hauteur du ventilateur de CPU ne dépasse pas 250 mm.

Limite de longueur de la carte (complémentaire) VGA :

Vérifiez que la longueur de votre carte (complémentaire) VGA ne dépasse pas 590 mm

Precaución

Limitación de altura del refrigerador de CPU:

Asegúrese de que la altura de su refrigerador de CPU no excede los 250 mm (9,8 pulgadas).

Limitación de longitud de la tarjeta de vídeo (adicional):

Asegúrese de que la longitud de su tarjeta de vídeo (adicional) no excede los 590 mm (23,2 pulgadas).

Attenzione!

Limitazione altezza dissipatore CPU:

Assicurarsi che l'altezza del dissipatore CPU NON superi 250 mm (9,8 pollici).

Limitazione lunghezza VGA (scheda aggiuntiva):

Assicurarsi che la lunghezza del VGA (scheda aggiuntiva) NON superi 590 mm (23,2 pollici).

Atenção!!

Limite de altura para o dissipador do CPU:

O limite de altura para o dissipador do CPU é 250 mm (9,8 polegadas).

Limite de comprimento para VGA (placa gráfica):

O limite de comprimento para VGA (placa gráfica) é 590 mm (23.2 polegadas).

警告！！

CPU 冷卻器的高度限制：

請確保 CPU 冷卻器的高度不超過 250 mm (9.8 英寸)。

VGA (附加介面卡) 的長度限制：

請確保 VGA (附加介面卡) 的長度不超過 590 mm (23.2 英寸)。

警告！！

CPU 散热器高度限制：

请确保 CPU 散热器的高度不超过 250 mm (9.8 英寸) 。

VGA (附加卡) 长度限制：

请确保 VGA (附加卡) 的长度不超过 590 mm (23.2 英寸) 。

警告

CPUクーラーの高さ制限:

CPUクーラーの高さが 250 mmを超えていないことを確認してください。

VGA (アドオンカード) の長さ制限:

VGA (アドオンカード) の長さが 590 mmを超えていないことを確認してください。

Внимание!

Ограничение по высоте охлаждающего ЦП

Убедитесь, что высота охлаждающего ЦП (центрального процессора) НЕ превышает 250 мм (9,8 дюйма).

Ограничение по длине видеокарты VGA (плата расширения)

Убедитесь, что длина видеокарты VGA (плата расширения) НЕ превышает 590 мм (23,2 дюйма).

Uyan!!

CPU Soğutucu Yükseklik Sınırlaması:

Lütfen CPU soğutucunuzun yüksekliğinin 250 mm'yi (9,8 inç) GEÇMEDİĞİNDEN emin olun.

VGA (Eklenti kartı) Uzunluk Sınırlaması:

Lütfen VGA'nızın (Eklenti kartı) uzunluğunun 590 mm'yi (23,2 inç) GEÇMEDİĞİNDEN emin olun.

คำเตือน!!

ขีดจำกัดความสูงสำหรับฮีตซิงก์ของ CPU:

ขีดจำกัดความสูงสำหรับฮีตซิงก์ของ CPU คือ 250 มม. (9.8 นิ้ว)

ขีดจำกัดความยาวสำหรับ VGA (การ์ดแสดงผล):

ขีดจำกัดความยาวสำหรับ VGA (การ์ดแสดงผล) คือ 590 มม. (23.2 นิ้ว)

Side Panels Disassembly

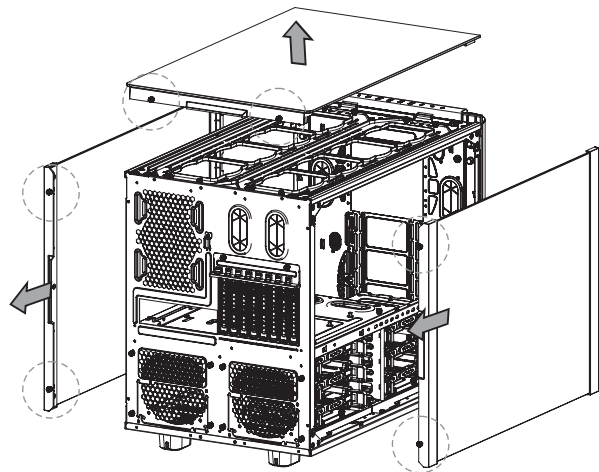

English /
Remove the screws on the back of the chassis, and open the side panel

Deutsch /
Entfernen Sie die Schrauben auf der Rückseite des Gehäuses und öffnen Sie das Seitenteil

Français /
Enlevez les vis à l'arrière du châssis et ouvrez le panneau latéral

Español /
Extraiga los tornillos de la parte posterior de la caja y abra el panel lateral

Italiano /
Rimuovere le viti sulla parte posteriore dello chassis e aprire il pannello laterale

Português /
Remova os parafusos na parte de trás da caixa e abra o painel lateral

繁體中文 /
移除機殼後方螺絲，將側窗打開

简体中文 /
卸除机壳后方螺丝，将侧窗打开

日本語 /
シャーシ背面のねじを取り外し、サイドパネルを開きます

Русский /
Открутите винты на задней стенке корпуса и откройте боковую панель

Türkçe /
Kasanın arkasındaki vidaları çıkarın ve yan paneli açın

ภาษาไทย /
ถอดสกรูที่ด้านหลังของแชสซีส์ แล้วเปิดแผงด้านข้าง

Power Supply Unit (PSU) Installation

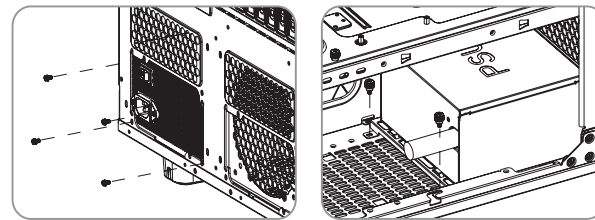
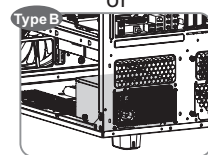
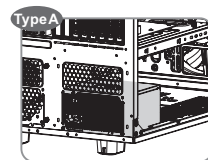

English /

1. Place the PSU in proper location.
2. Adjust the PSU supporting bridge to the proper location and secure the PSU with screws.

Deutsch /

1. Platzieren Sie das Netzteil in der richtigen Position.
2. Richten Sie die Stützbrücke für das Netzteil entsprechend aus und sichern Sie das Netzteil mit Schrauben.

Français /

1. Placez l'alimentation dans la position appropriée.
2. Ajustez le pont de support de l'alimentation dans la position appropriée et fixez l'alimentation à l'aide des vis.

Español /

1. Instale la PSU en la ubicación correcta.
2. Ajuste el puente de soporte de la PSU en la ubicación adecuada y asegúrela con tornillos.

Italiano /

1. Posizionare la PSU in modo corretto.
2. Regolare il ponticello di supporto della PSU nella posizione corretta e fissare la PSU con delle viti.

Português /

1. Coloque o PSU na sua devida posição.
2. Ajuste a ponte de suporte do PSU para a devida posição e fixe o PSU com parafusos.

繁體中文 /

1. 將電源供應器放在正確的位置
2. 將電源供應器支撐架調整到適當的位置，然後用螺絲固定電源供應器。

简体中文 /

1. 将电源供应器放在正确的位置
2. 将电源供应器支撑架调整到适当的位置，然后用螺丝固定电源供应器。

日本語 /

1. PSUを適切なロケーションに取り付けます。
2. PSU支持ブリッジを適切なロケーションに合うように調整し、ねじでPSUを締め付けます。

Русский /

1. Установите блок питания в надлежащее место.
2. Надлежащим образом установите поддерживающий мост блока питания и закрепите блок питания винтами.

Türkçe /

1. PSU'yu, uygun konuma yerleştirin.
2. PSU destek köprüsünü uygun konuma ayarlayın ve PSU'yu vidalarla sabitleyin.

ภาษาไทย /

1. วาง PSU ในตำแหน่งที่เหมาะสม
2. ขยับบริดจ์ที่รองรับ PSU ให้อยู่ในตำแหน่งที่เหมาะสม แล้วขันสกรูยึด PSU ให้แน่น

Motherboard Installation

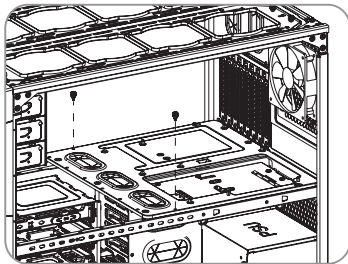

English /
Install the motherboard in proper location and secure it with screws.

Deutsch /
Installieren Sie die Hauptplatine in ihrer vorgesehenen Position und sichern Sie sie mit Schrauben.

Français /
Installez la carte mère dans l'endroit approprié et sécurisez-la avec des vis.

Español /
Instale la placa madre en la ubicación adecuada y asegúrela con tornillos.

Italiano /
Installare la scheda madre nella posizione appropriata e fissarla con le viti.

Português /
Instale a motherboard no local adequado e aparafuse.

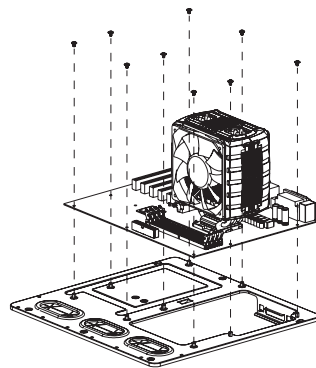

繁體中文 /
將主機板放置在合適的位置並用零件包中之螺絲固定。

简体中文 /
在合适的位置安装主板并以螺丝安全固定。

日本語 /
マザーボードを適切な場所に取り付け、ねじで固定します。

Русский /
Установите материнскую плату в надлежащее место и закрепите ее винтами.

Türkçe /
Ana kartı uygun konuma takın ve vidalarla sabitleyin.

ภาษาไทย /
ติดตั้งเมนบอร์ดในตำแหน่งที่เหมาะสมแล้วขันสกรูยึดให้แน่น

3.5" & 2.5" HDD Installation

Type A: HDD Cage Installation

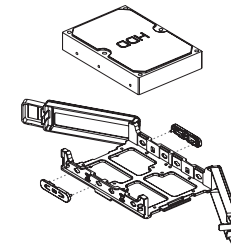
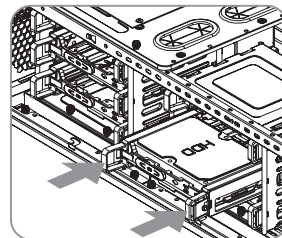
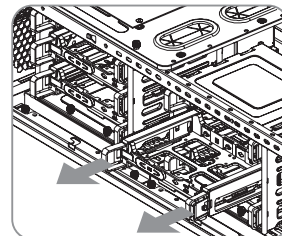

For 3.5" HDD:
Secure 3.5" HDD from both side of the HDD tray by locking clips.

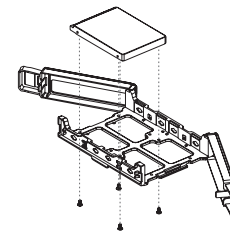

For 2.5" HDD:
Secure 2.5" HDD from the bottom of the HDD by screws.

Type B: Center Plate Installation

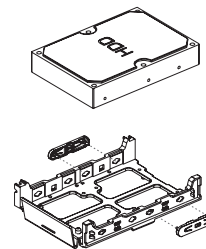
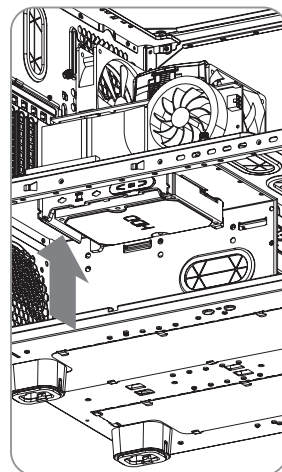

For 3.5" HDD:
Secure 3.5" HDD from both side of the HDD tray by locking clips.

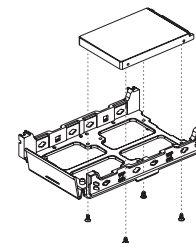

For 2.5" HDD:
Secure 2.5" HDD from the bottom of the HDD by screws.

Type C1: M/B Tray Installation (With HDD Tray)

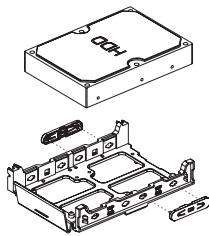
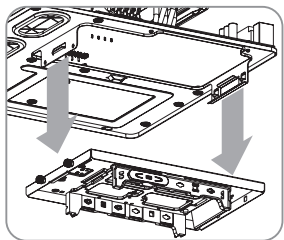

For 3.5" HDD:
Secure 3.5" HDD from both side
of the HDD tray by locking clips.

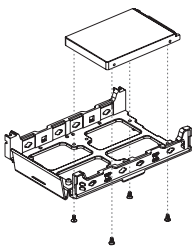
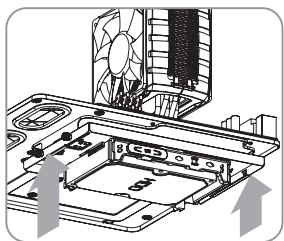

For 2.5" HDD:
Secure 2.5" HDD from the
bottom of the HDD by screws.

Type C2: M/B Tray Installation (Without HDD Tray)

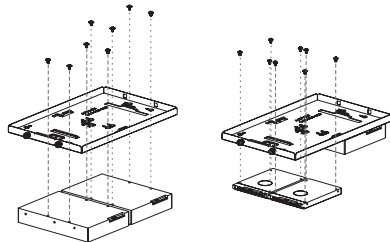
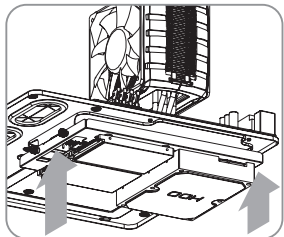

PCI Card Installation

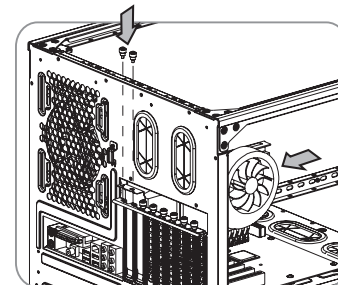
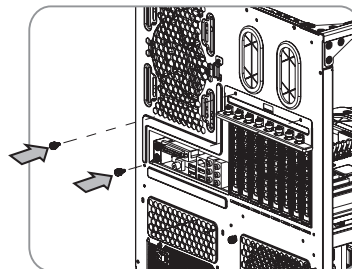

English /
Insert the PCI card into the PCI slot, and
secure it with screw.

Deutsch /
Stecken Sie die PCI Karte in den PCI
Steckplatz und sichern Sie sie mit
Schrauben.

Français /
Insérez la carte PCI dans le slot PCI et
sécurisez-la avec des vis.

Español /
Inserte la tarjeta PCI en la ranura del PCI y
asegúrela con tornillos.

Italiano /
Inserire la scheda PCI nello slot PCI e
fissarla con la vite.

Português /
Insira a placa PCI na ranhura PCI e fixe
com parafusos.

繁體中文 /
將 PCI 卡插入 PCI 插槽，然後用螺絲固定。

简体中文 /
將 PCI 卡插入 PCI 插槽并以螺絲固定。

日本語 /
PCI カードを PCI スロットに挿入し、ねじ
で固定します。

Русский /
Вставьте PCI-карту в слот PCI и закрепите
ее винтом.

Türkçe /
PCI kartını, PCI yuvasına yerleştirin ve
vidayla sabitleyin.

ภาษาไทย /
ใส่การ์ด PCI ในสล็อต PCI
แล้วขันสกรูยึดให้แน่น

Air Cooling Installation

Top

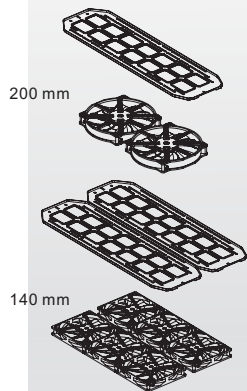

200 mm

140 mm

Front:

3 x 120 mm

2 x 140 mm

2 x 200 mm

Top:

8 x 120 mm

6 x 140 mm

2 x 200 mm

Rear:

2 x 120 mm or 2 x 140 mm

Left / Right Side:

4 x 120 mm

3 x 140 mm

Rear

140 mm

120 mm

140 mm

120 mm

120 mm

140 mm

200 mm

Side

140 mm

120 mm

Bottom

Front

Liquid Cooling Installation

Top

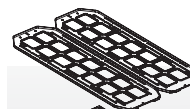

420 mm

480 mm

360 mm

180 mm

120 mm

140 mm

Rear

Front:

1 x 280 mm or 1 x 360 mm

or 1 x 180 mm or 1 x 360 mm (200 mm series)

Top:

1 x 180 mm or 1 x 360 mm (200 mm series)

or 2 x 480 mm or 2 x 420 mm

Rear: 1 x 120 mm or 1 x 140 mm

Left / Right Side:

1 x 480 mm or 1 x 420 mm

or 1 x 480 mm or 1 x 420 mm

Side

420 mm

480 mm

280 mm

360 mm

180 mm

360 mm

Bottom

420 mm

480 mm

Front

Bracket Installation

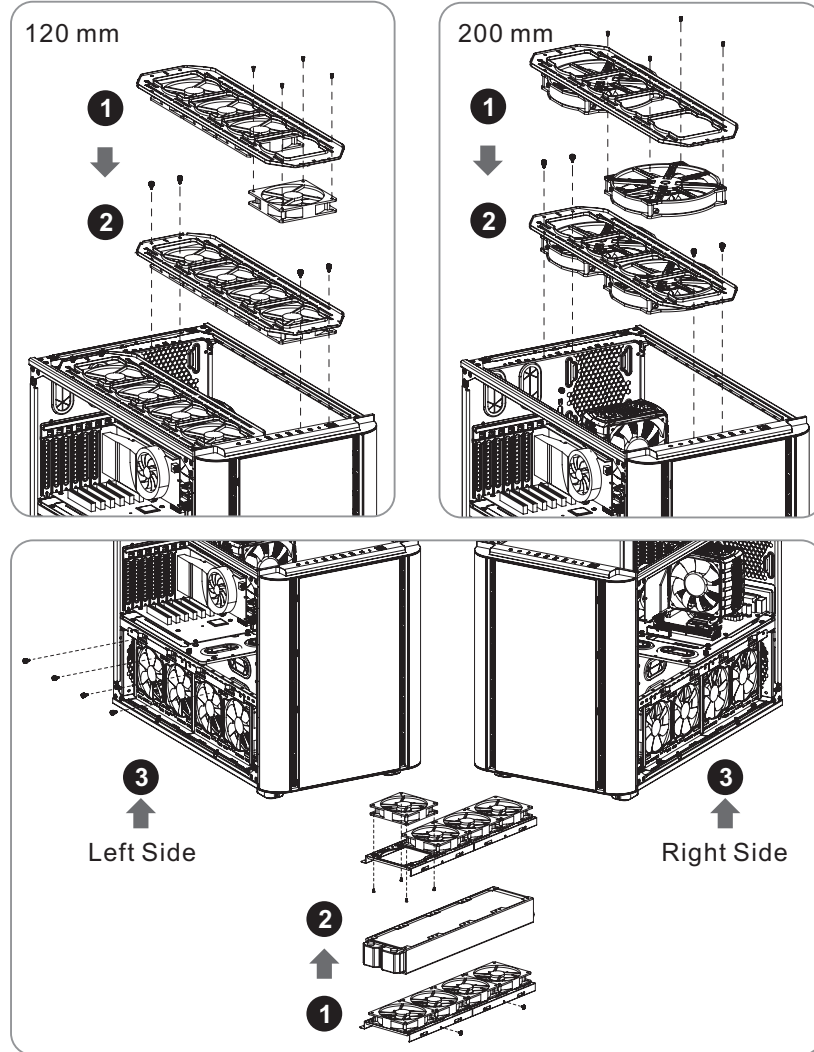

Leads Installation

English

Leads Installation Guide

Case LED Connection / On the front of the case, you can find some LEDs and switch leads. Please consult your user manual of your motherboard manufacturer, then connect these leads to the panel header on the motherboard.

USB 2.0 Connection / Please consult your motherboard manual to find out the section of "USB connection".

USB 3.0 connection /

1. Make sure your motherboard supports USB 3.0 connection.

2. Connect the USB 3.0 cable to the available USB 3.0 port on your computer.

Audio Connection / Please refer to the following illustration of Audio connector and your motherboard user manual. Please select the motherboard which used AC'97 or HD Audio(Azalia),(be aware of that your audio supports AC'97 or HD Audio (Azalia)) or it will damage your device(s).

Deutsch

Anschlüsse herstellen

Gehäuse-LED-Verbindungen / Auf der Gehäusevorderseite finden Sie einige LEDs und Verbindungen. Bitte nehmen Sie die Gebrauchsanweisung Ihres Motherboard Herstellers zur Hilfe und schließen Sie diese Verbindungen an die Panel Header Belegung des Motherboards an.

USB 2.0 Anschluss / Bitte nehmen Sie die Gebrauchsanweisung Ihres Motherboards zur Hilfe und lesen Sie unter dem Kapitel „USB Anschlüsse“ nach.

USB 3.0 Anschluss /

1. Stellen Sie sicher, dass Ihre Hauptplatte den USB 3.0 Anschluss unterstützt.

2. Verbinden Sie das USB 3.0 Kabel mit dem USB 3.0 Port auf Ihrem Computer.

Audio Anschlüsse / Bitte beachten Sie die folgende Abbildung der Audio Anschlüsse und die Anweisung in der Gebrauchsanweisung Ihres Motherboards. Bitte wählen Sie das Motherboard, das AC'97 oder HD Audio(Azalia) verwendet, (achten Sie darauf, dass Ihr Audio AC'97 bzw. HD Audio (Azalia unterstützt)). Andernfalls entstehen schwere Schäden an Ihrem(n) Gerät(en)!!!

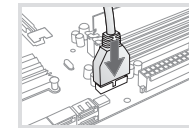
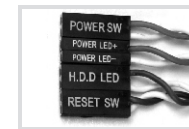

USB 3.0 Connection

L-OUT		SENSE2
SENSE		KEY
R-OUT		SENSE1
MIC-POWER		PRESENSE
MIC-IN		GND

AUDIO AZALIA Function

L-OUT		L-RET
		KEY
R-OUT		R-RET
MIC-POWER		
MIC-IN		GND

AUDIO AC'97 Function

Français

Guide d'installation des fils

Connexion des voyants du boîtier / Sur la face avant du boîtier, vous trouverez plusieurs voyants et les fils des boutons. S'il vous plaît consultez le guide d'utilisateur du fabricant de votre carte mère, puis connectez ces fils aux connecteurs sur la carte mère.

Connexion USB 2.0 / S'il vous plaît consultez le manuel de votre carte mère à la section "Connexion USB"

Connexion USB 3.0 /

1. Vérifiez que votre carte mère prend en charge la connexion USB 3.0.
2. Connectez le câble USB 3.0 au port USB 3.0 disponible sur votre ordinateur.

Connexion Audio / S'il vous plaît référez vous à l'illustration suivante du connecteur audio et au guide de l'utilisateur de votre carte mère. S'il vous plaît sélectionnez une carte mère supportant AC'97 ou HD Audio (Azalia), (faites attention que votre audio supporte l'AC'97 ou HD Audio (Azalia)) sinon cela pourrait endommager votre matériel.

Español

Guía de Instalación de Cables

Conexión del LED de la caja / En la parte frontal de la caja, encontrará algunos LED y cables de interruptores. Consulte el manual del usuario del fabricante de la placa madre, a continuación conecte estos cables al conector de la placa madre.

Conexión USB 2.0 / Consulte el manual de la placa madre para obtener más información sobre el apartado "Conexión USB"

Conexión USB 3.0 /

1. Asegúrese de que la placa base admite conexión USB 3.0.
2. Conecte el cable USB 3.0 al puerto USB 3.0 disponible en el equipo.

Conexión de Audio / Consulte la siguiente ilustración del conector de Audio y el manual del usuario de la placa madre. Seleccione la placa madre que utiliza AC'97 o HD Audio (Azalia), (asegúrese de que su audio admite AC'97 o HD Audio (Azalia)) si no, sus dispositivos resultarán dañados

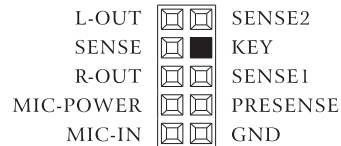
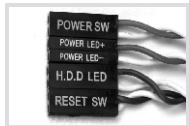

AUDIO AZALIA Function

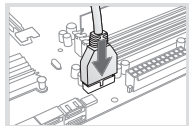

USB 3.0 Connection

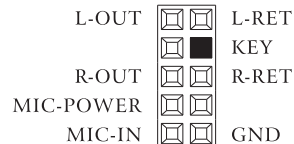

AUDIO AC'97 Function

Italiano

Guida di installazione dei contatti

Connessione del LED del case / Nella parte anteriore del case, sono presenti alcuni contatti per interruttori e LED. Consultare il manuale utente del produttore della scheda madre, quindi connettere i contatti alla parte superiore del pannello sulla scheda madre.

Connessione USB 2.0 / Consultare il manuale per la scheda madre che comprende la sezione relativa alla "connessione USB".

Connessione USB 3.0 /

1. Accertarsi che la scheda madre supporti la connessione USB 3.0.
2. Collegare il cavo USB 3.0 alla porta USB 3.0 disponibile sul computer.

Connessione Audio / Fare riferimento all'illustrazione riportata di seguito del connettore Audio e al manuale utente per la scheda madre. Selezionare la scheda madre relativa a AC'97 o HD Audio (Azalia) e considerare che il supporto audio è compatibile con AC'97 o HD Audio (Azalia); in caso contrario, le periferiche potrebbero venire danneggiate.

Português

Guia de Instalação Eléctrica

Ligação do LED da Caixa / Na parte dianteira da caixa pode encontrar alguns LEDs e fios eléctricos. Consulte o manual de utilizador do fabricante da sua motherboard e ligue os fios à parte superior do painel na motherboard.

Ligação USB 2.0 / Consulte o manual da sua motherboard para ver a secção de "Ligação USB".

Ligação USB 3.0 /

1. Certifique-se que a sua motherboard suporta ligação USB 3.0.
2. Ligue o cabo USB 3.0 à porta USB 3.0 disponível no seu computador.

Ligação Audio / Consulte a imagem seguinte do conector Áudio e o manual de utilizador da sua motherboard.

Selecione a motherboard que utiliza AC'97 ou HD Áudio (Azalia), (verifique se a sua placa de áudio suporta AC'97 ou HD Áudio (Azalia)) ou irá danificar o(s) seu(s) dispositivo(s).

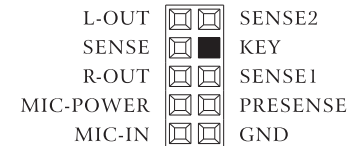
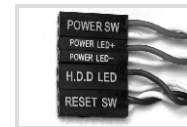

AUDIO AZALIA Function

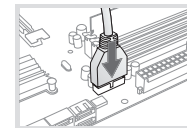

USB 3.0 Connection

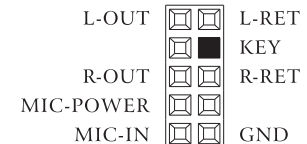

AUDIO AC'97 Function

繁體中文

線材安裝說明

機殼LED連接方式 / 在機殼前方的面板後面，可以找到一些LED與開關線材 (POWER Switch....)，請參考主機板使用說明書，並將機殼上的線材正確地連接到主機板上，這些線材通常都會印有標籤在上面，如果沒有的話，請找出機殼前面板上線材原本的位置以知道正確的來源。

USB 2.0 連接 / 請參考主機板使用手冊找出主機板上的USB連接孔位

USB 3.0 連接 /

1. 請確認主機板是否支援USB 3.0傳輸介面。

2. 連接USB 3.0傳輸線至主機板上的USB3.0接埠。

音效連接 / 請根據下面的音源接頭圖示與主機板使用手冊來連接音效裝置，請確認主機板上的音效裝置是支援AC'97音效或是HD音效(Azalia)，裝置錯誤可能會導致主機板音效裝置的毀損，某些主機板的音效裝置不會與下方的圖示完全相同，請參酌主機板使用手冊以得到正確的安裝位置

简体中文

线材安装说明

机壳LED连接方式 / 在机壳前方的面板后面，可以找到一些LED与开关线材 (POWER Switch....)，请参考主板使用说明书，并将机壳上的线材正确地连接到主板上，这些线材通常都会印有标签在上面，如果没有的话，请找出机壳前面板上线材原本的位置以知道正确的来源。

USB 2.0 连接 / 请参考主板使用手册找出主板上的USB连接孔位

USB 3.0 连接 /

1. 请确认主板是否支持USB 3.0传输接口。

2. 连接USB 3.0传输线至主板上的USB3.0接埠。

音效连接 / 请根据下面的音源接头图示与主板使用手册来连接音效装置，请确认主板上的音效装置是支持AC'97音效或是HD音效(Azalia)，装置错误可能会导致主板音效装置的毁损，某些主板的音效装置不会与下方的图标完全相同，请参酌主板使用手册以得到正确的安装位置

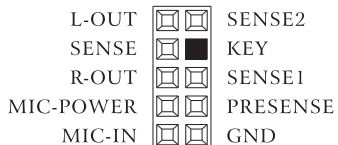
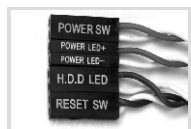

AUDIO AZALIA Function

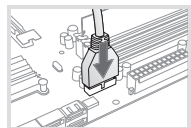

USB 3.0 Connection

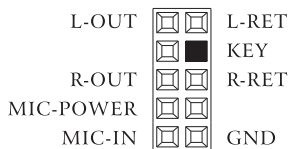

AUDIO AC'97 Function

日本語

リード線の取り付けガイド

ケース LED の接続 / ケース前面には、LEDとスイッチリード線があります。マザーボードメーカーのユーザーマニュアルを参照し、これらのリード線をマザーボードのパネルヘッダに接続してください。

USB 2.0 の接続 / マザーボードのマニュアルを参照して、「USB接続」のセクションを探します。

USB 3.0 の接続 /

1. お使いのマザーボードがUSB 3.0接続をサポートしていることを確認してください。

2. USB 3.0ケーブルをコンピュータの空いているUSB 3.0ポートに接続します。

オーディオ接続 / オーディオコネクタの次の図とマザーボードのユーザーマニュアルを参照してください。AC'97またはHDオーディオ(Azalia)を使用するマザーボードを選択してください(オーディオがAC'97またはHDオーディオ(Azalia)をサポートしていることを確認してください)。サポートしていないと、デバイスが損傷します。

Русский

Указания по прокладке кабелей

Подключение индикаторов корпуса / В передней части корпуса расположены индикаторы и провода выключателей. Перед подсоединением этих проводов к монтажной колодке панели на материнской плате изучите руководство пользователя производителя материнской платы.

Подключение USB 2.0 / См. раздел «Подключение USB» в руководстве материнской платы.

Подключение USB 3.0 /

1. Убедитесь, что материнская плата поддерживает подключение по стандарту USB 3.0.

2. Подсоедините кабель USB 3.0 к свободному порту USB 3.0 компьютера.

Подключение аудиоразъема / См. следующую иллюстрацию аудиоразъема и руководство пользователя материнской платы. Выберите материнскую плату, в которой используется кодек AC'97 или HD Audio (Azalia) (убедитесь, что звуковая плата поддерживает кодек AC'97 или HD Audio (Azalia)). В противном случае можно повредить устройства.

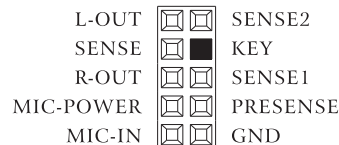

AUDIO AZALIA Function

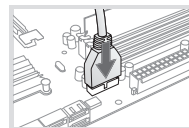

USB 3.0 Connection

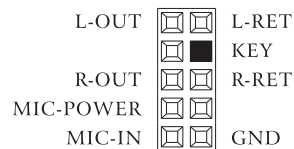

AUDIO AC'97 Function

Türkçe

Ara Kablo Kurulum Kılavuzu

Kasa ışık bağlantısı / Kasanın ön kısmında bazı ışıklar ve anahtar ara kabloları görebilirsiniz. Lütfen anakart üreticinizin sağladığı kullanım kılavuzuna bakın ve daha sonra, bu ara kabloları, anakart üzerindeki panel bağlantı noktalarına bağlayın. USB 2.0 bağlantısı / Lütfen anakart kılavuzunuzun "USB bağlantısı" bölümüne bakın. USB 3.0 Bağlantısı /

1. Ana kartınızın USB 3.0 bağlantısını desteklediğinden emin olun.
2. USB 3.0 kablolarını, bilgisayarınızdaki kullanılabilir USB 3.0 bağlantı noktasına bağlayın.

Ses Bağlantısı / Lütfen aşağıdaki Ses konektörü resmine ve anakartınızın kullanım kılavuzuna bakın. Lütfen AC'97 veya HD Audio(Azalia) spesifikasyonunu kullanan bir anakart seçin (ses sisteminizin AC'97 veya HD Audio (Azalia) spesifikasyonunu desteklediğini unutmayın); aksi takdirde, aygıt(lar)ınız zarar görür.

ภาษาไทย

คู่มือการติดตั้งสายไฟ

การเชื่อมต่อไฟ LED ของเคส / ที่ด้านหน้าของเคส คุณจะเห็นไฟ LED และสายไฟของสวิตช์ กรณีศึกษารายละเอียดจากคู่มือผู้ใช้ของผู้ผลิตแผงวงจรหลักของคุณ จากนั้นให้เชื่อมต่อสายไฟเหล่านี้เข้ากับส่วนหัวของแผงวงจรหลัก การเชื่อมต่อ USB 2.0 / กรณีศึกษารายละเอียดจากคู่มือผู้ใช้ของผู้ผลิตแผงวงจรหลักของคุณ ในหัวข้อ "การเชื่อมต่อ USB" การเชื่อมต่อ USB 3.0 /

1. ตรวจสอบให้แน่ใจว่าแผงวงจรหลักของคุณรองรับการเชื่อมต่อ USB 3.0
2. เชื่อมต่อสาย USB 3.0 เข้ากับพอร์ต USB 3.0 ที่สามารถใช้งานได้บนคอมพิวเตอร์ของคุณ

การเชื่อมต่ออุปกรณ์รับส่งสัญญาณเสียง/ กรณีศึกษารายละเอียดจากภาพประกอบของตัวเชื่อมต่อสัญญาณเสียงต่อไป และคู่มือผู้ใช้ของผู้ผลิตแผงวงจรหลักของคุณ กรณีศึกษาเลือกแผงวงจรหลักที่ใช้ AC'97 หรือ HD Audio(Azalia) (กรุณาตรวจสอบให้แน่ใจว่าอุปกรณ์รับส่งสัญญาณเสียงของคุณรองรับ AC'97 หรือ HD Audio (Azalia)) มิฉะนั้นอุปกรณ์ของคุณอาจเสียหายได้

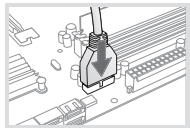
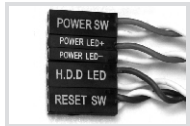

USB 3.0 Connection

L-OUT		SENSE2
SENSE		KEY
R-OUT		SENSE1
MIC-POWER		PRESENSE
MIC-IN		GND

AUDIO AZALIA Function

L-OUT		L-RET
		KEY
R-OUT		R-RET
MIC-POWER		
MIC-IN		GND

AUDIO AC'97 Function

Thermaltake Power Supply Series (Optional)



What is Smart Power Management (SPM)?

Smart Power Management (SPM) is a cloud-based software that seamlessly integrates three intelligent platforms – DPS G PC APP 3.0, DPS G Smart Power Management Cloud 1.0 and DPS G Mobile APP 1.0 – and compiles key statistics about your PC into detailed charts and breakdowns for your instant PC status view and management. With easy access to SPM through your PC or mobile devices, whether you are outside or indoors, enjoy taking full control of your build anytime, anywhere!



Thermaltake has several power supply product lines; please refer to our official website and Facebook Fan Page for more detail information!

Brand official website:

<http://www.thermaltake.com/>

Global Facebook :

<https://www.facebook.com/ThermaltakeInc>

Taiwan Facebook

<https://www.facebook.com/ThermaltakeTW>



Learn more about SPM

Tt RGB Plus Ecosystem



Tt RGB Plus Software

Thermaltake's patented software to synchronize TT RGB PLUS products with addressable LEDs.



Tt AI Voice Control

Give you full control over the TT RGB PLUS products with your voice.



SyncALL, Say "Hello TT"



Download on the App Store



GET IT ON Google play



Learn more about TT RGB Plus