

Ninebot Mini Scooter

Content

1.	Device and Hardware	03
2.	Functions	04
3.	Assembling device casing	05
4.	Charging device	05
5.	Using device	06
6.	Riding instructions.....	07
7.	Avoiding potentially dangerous situations	08
8.	Preventing dangerous riding.....	09
9.	Safety recommendations	12
10.	Transportation and energy saving mode	11
11.	Maintenance and storage.....	13
12.	Table of device parameters.....	14
13.	Information on the presence of toxic and hazardous substances	15
14.	Trademark and Legal notices.....	15
15.	Warranty service.....	16
16.	Maintenance service.....	17

Welcome!

Thank you for your choice of Segway Ninebot Mi Scooter (hereinafter referred to as the Mini). Mini - is a smart portable electronic Segway, as well as a modern active way of entertainment.

Feel the Segway and get a lot of pleasure from riding it!

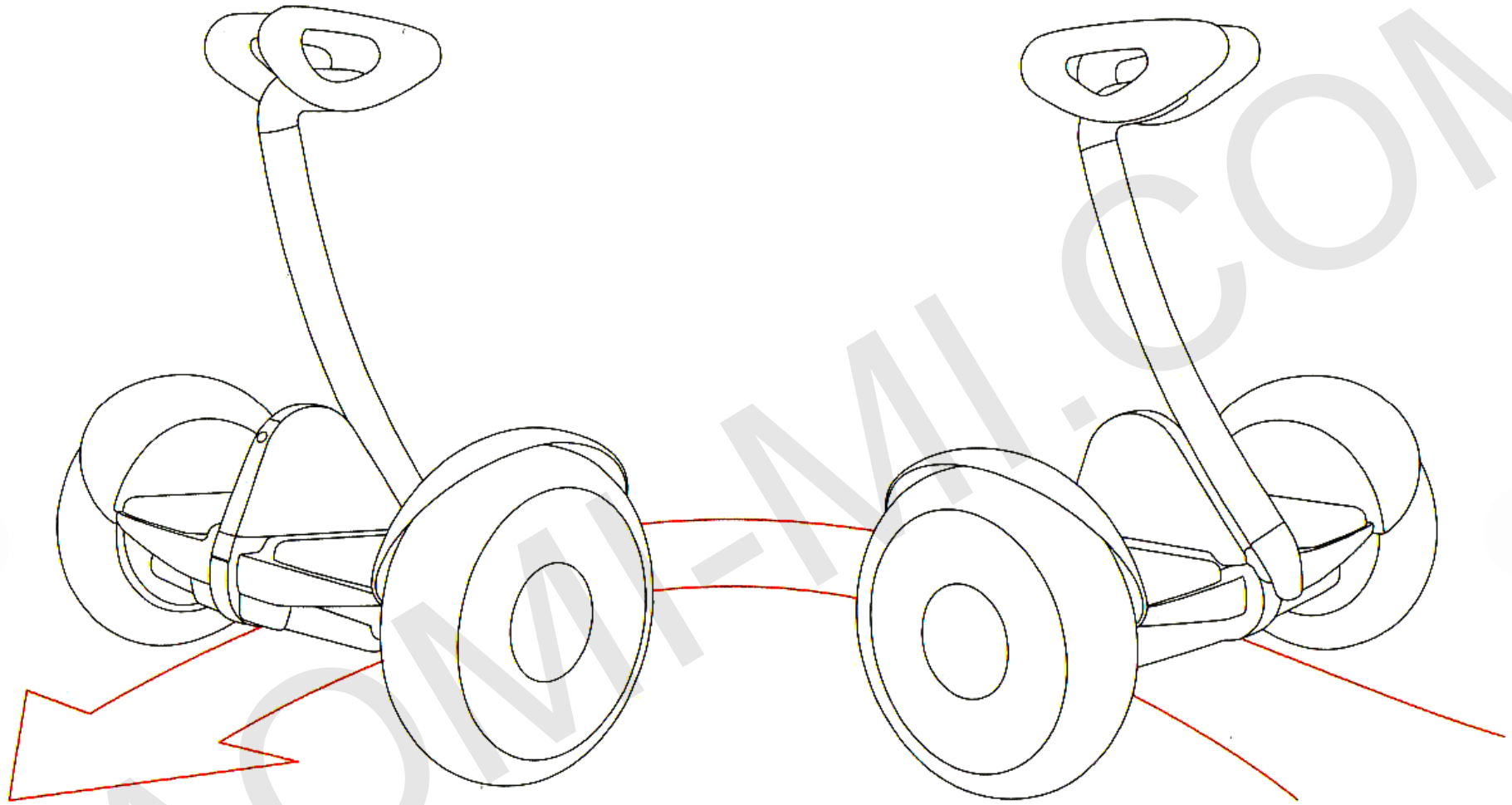

The front side of Segway

The back side of Segway

**Note: to getting up / getting off from Segway
must only be done from the back side!**

1. Device and Hardware

Carefully review and check all the hardware in the box, as they must be in perfect condition.

If you find that some of the components are missing or damaged, please, visit the service Xiaomi <http://fuwu.mi.com> or call for Technical Support.

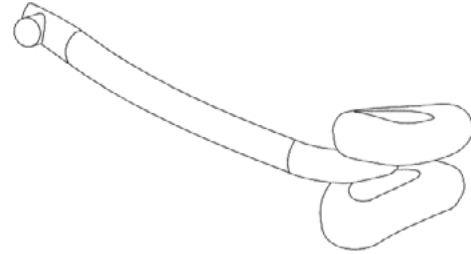

Steering rack

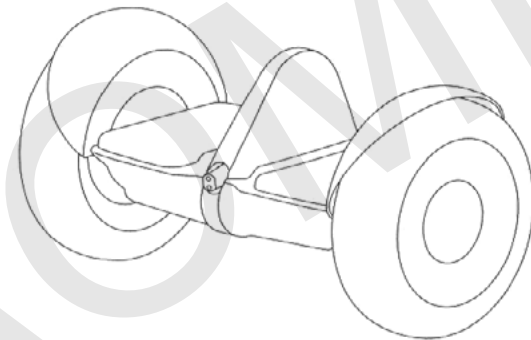

Segway case

Map with brief information



Manual

Disclaimer

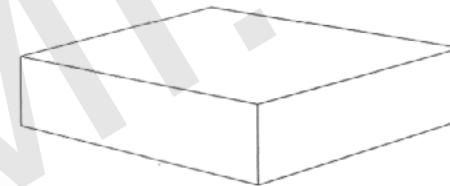

Box with hardware

Protective cover

Air vent



Screws x2

Spanner

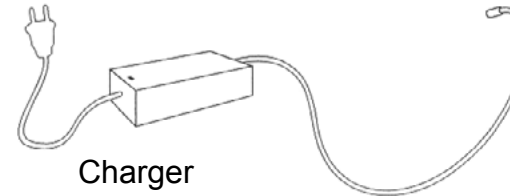

Charger

2. Features

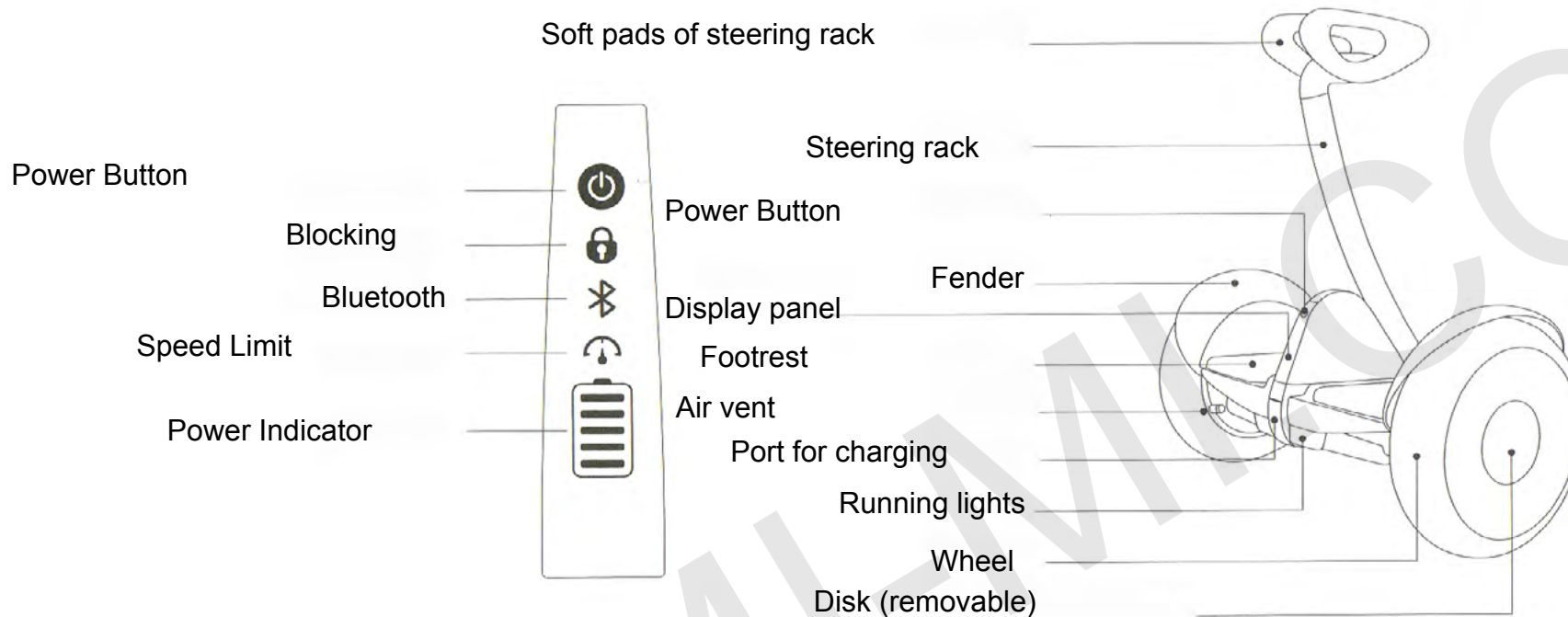

Power Button



Turn on / off of Mini general power . After turning on segway, if it is not used for 10 minutes, or if the casing of the device is in the inverted state for more than 5 minutes, the Segway is automatically switched off.

Blocking



Use a custom application Ninebot (hereinafter referred to as App) to lock. After that, no matter who tried to take the Mini, Segway will begin to vibrate and audible alarm is activated; at this time, if you are in the range of reach of Bluetooth signal, your smartphone will also start to vibrate, thus warning of the danger

Bluetooth



A flashing light of Bluetooth indicates on turned on Bluetooth signal and the lack of connected smartphones; A steady light indicates a successful connection to your phone.

Speed Limit



Light of speed limit indicator indicates that the Mini has a speed limitation. When exceeding the speed, user can clearly feel the footrest is raised, after which it will be very difficult to speed up. Default Segway has a speed limit of 7km / h, but you can enter in a custom application APP and remove the speed limit or change the settings.

Power Indicator



Whenever segway charge level reaches 20%, the power indicator of device starts blinking, indicating that it must be recharged. Log in to the user application App to find out the exact charge level of segway and estimate the distance that he can overcome. When the battery level is below 30%, segways gradually reduces the speed and you may hear an audible alarm when the battery level is below 10% - Mini limits the speed to 7 km / h.

3. Assembling the casing

1 Set the steering rack to the corresponding slot on the back side of segway

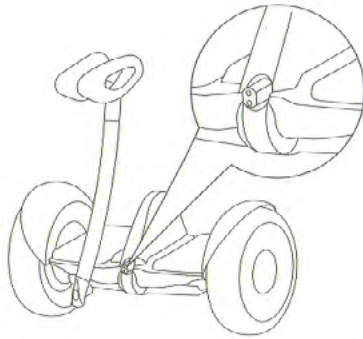

2 Place screws

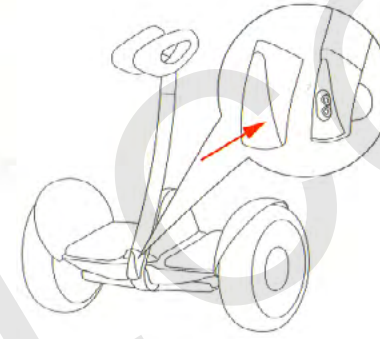
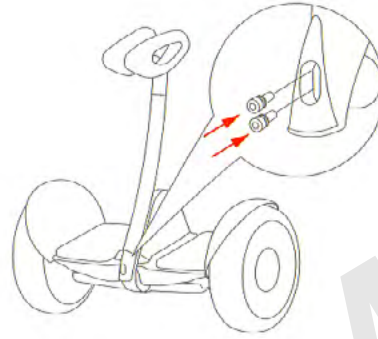

3 Place the cover (a click indicates a successful installation of the cover)

After installation of all components, align device and check all closing and opening mechanisms.

For your safety, after turning on Segway Ninebot Mi Scooter you will hear a continuous beep, but its speed and sensitivity level are very low, so it can not be used immediately. You must install on your smartphone user application Ninebot (APP) and activate it using manual application.

4. Charging device

Open the rubber cap

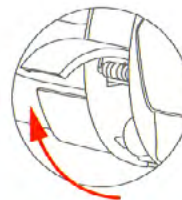

Open the protective panel

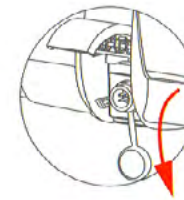

Plug the cable into the hole

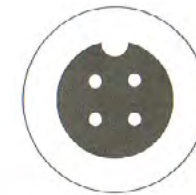

Port for charging

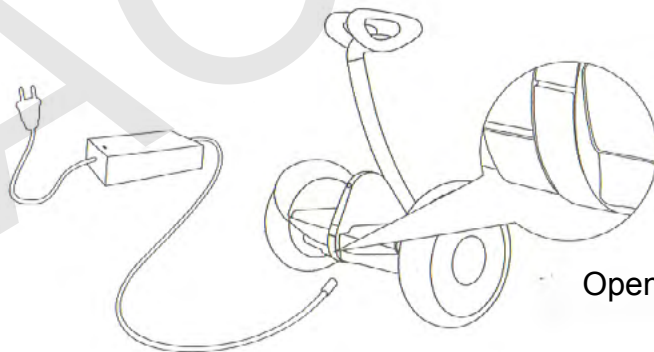

5. Using the device

For those who did not ride on the Mini earlier, there are certain risks, so you definitely need to be trained, after which you will be able to ride a Segway.



Download the user application Ninbot App on your smartphone (Android system and iOS), check the recommendations on the safe riding of Segway and after some training (if you are a beginner), you can start to use the vehicle. To quickly download the application, visit the App Store and get Ninbot App or scan QR-code.

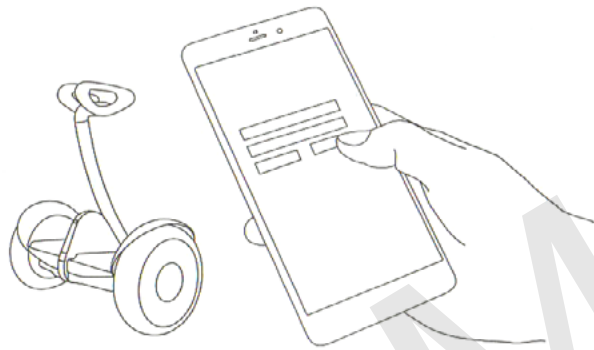

1 Download the app and register Ninbot

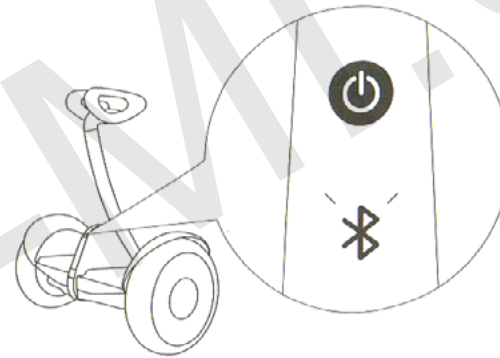

2 Turn on the Segway, and it will flash Bluetooth indicator, indicating the expectation of connecting other devices

3 Click on «search for new devices» and connect to the Mini. After a successful pairing, you will hear an audible alarm of segway and its Bluetooth indicator is now permanently on.

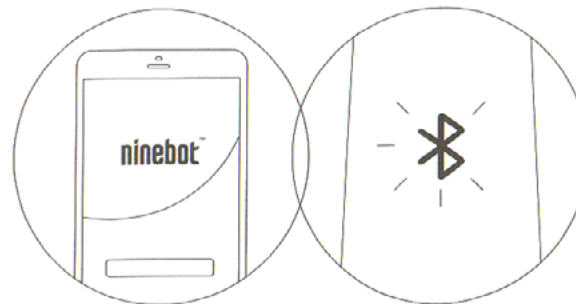

After successfully connecting devices, carefully follow instructions of the App

6. Instructions for riding

While studying you can fall and get hurt, so wear helmet and protective gear, as shown.

After activating the Mini, the App will ask you to start learning, follow the step by step exercises. You can also train step by step according to the figures shown below.

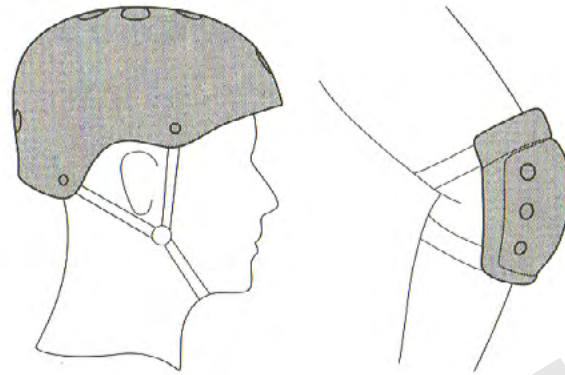

2. Put one foot on the footrest. Avoid accidentally touching with shin or knee pads of steering rack, as this may lead to an unexpected turn of segway.

For your safety, after completion of training, Mini can independently enter the speed limit up to 7 km / h and will be changing direction slowly enough.

After completing the training course, Mini can increase the speed limit of 10km / h, and after you reach a 1 km run it will automatically remove the speed limit.

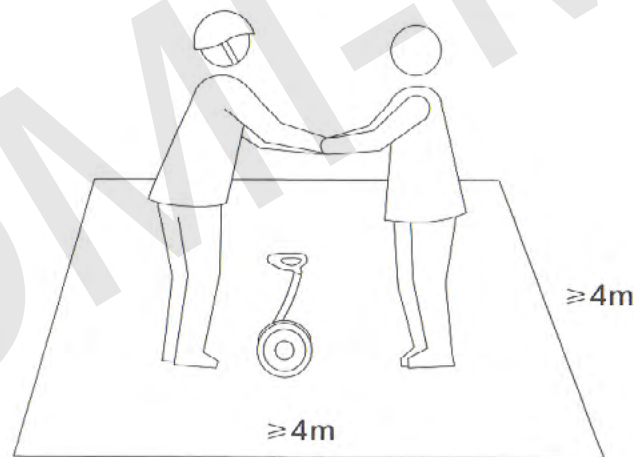

1. If you are going to experience a Segway for the first time, do this in open space, and use the help of another person to get on or get off the Segway. Note: getting up / getting off the segway can only be done from the back side.



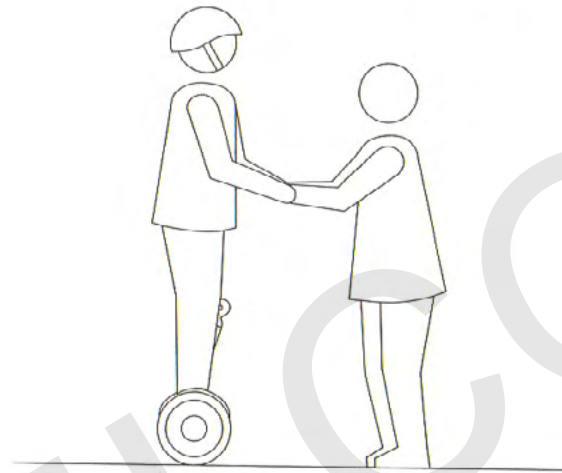
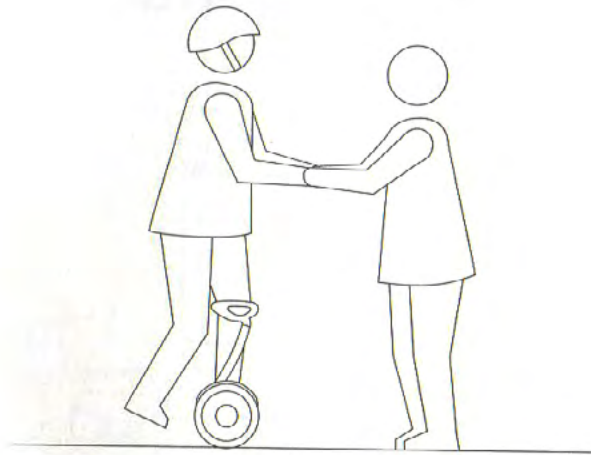

3. Take a stable position, slowly move the center of gravity on a footrest.

4. Put the other foot on the footrest. Relax your body, stand up straight and look ahead, avoid sudden movements.

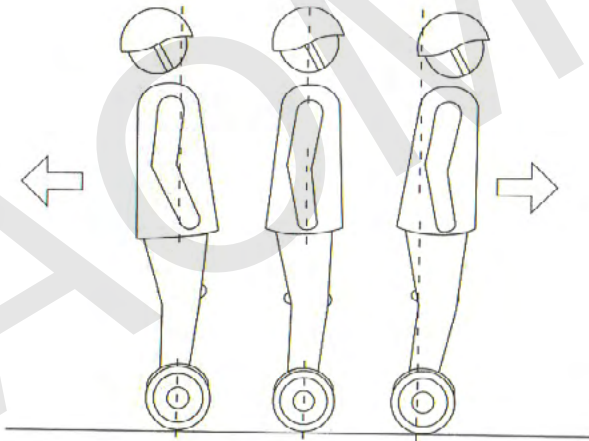

5. To control segway, slowly move the center of gravity of the body forward and back.

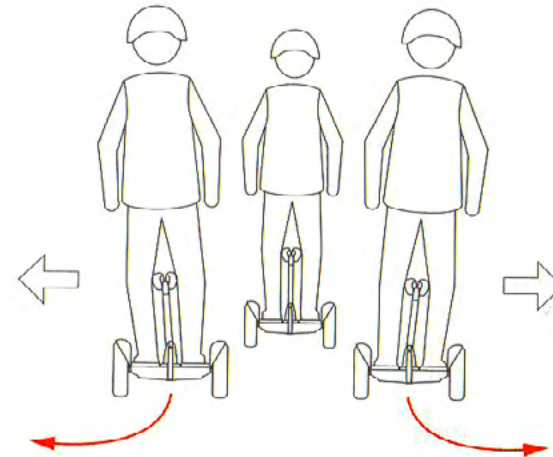

6. To turn right (left), you need a little touch to the foot pad of a steering rack. Avoid collision or hitting of wheels of segway to any obstacles.

7. Avoiding potentially dangerous situations

Avoid collision or hitting wheels on the various obstacles, otherwise it may cause damage to wheels and lose control of the device.



If you ride on a rough road, you need to stick to a low speed (3-10km / h), and you can slightly bend your knees, it will help you to better adapt and adjust to the uneven road.



If on your way there were «sleeping policemen», the threshold of the elevator, potholes or other obstacles, it is not recommended to pass through them at too fast or too slow speed, otherwise it could lead to slip or locking of the Segway wheels.

Entering into any room, elevator, etc., avoid hitting, particularly the head of the door frame.

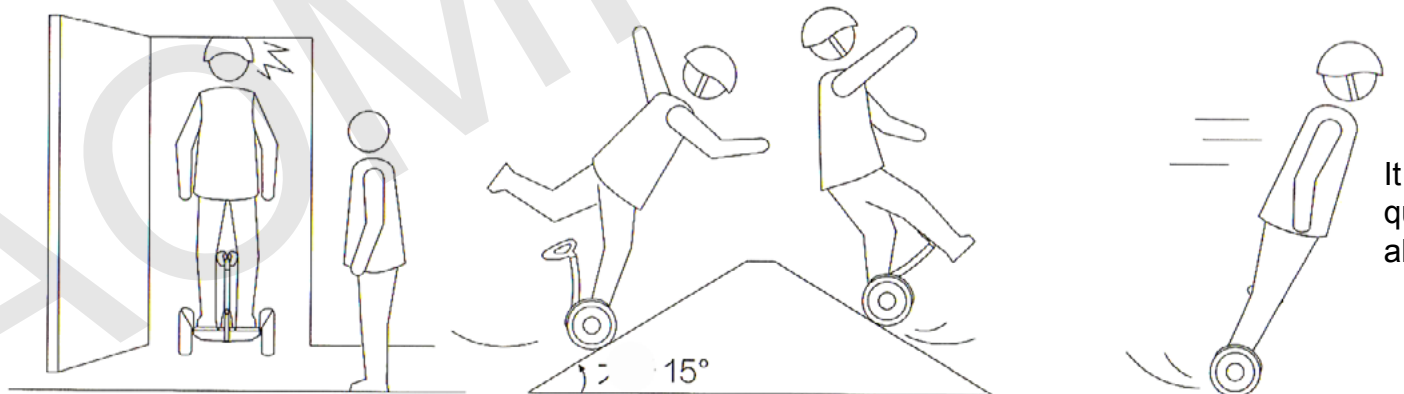



It is not recommended to quickly speed up and stop abruptly.



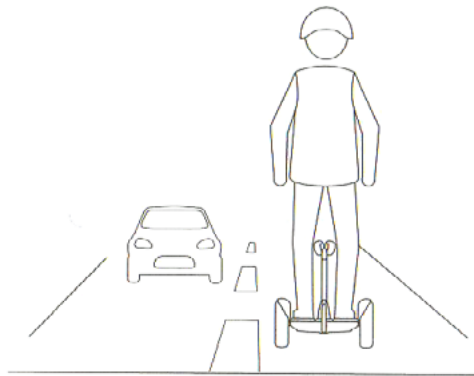

Do not use a Segway to ride on the ramp, which rises on more than 15°, since, due to insufficient power, Mini may roll over.

8 Preventing dangerous riding

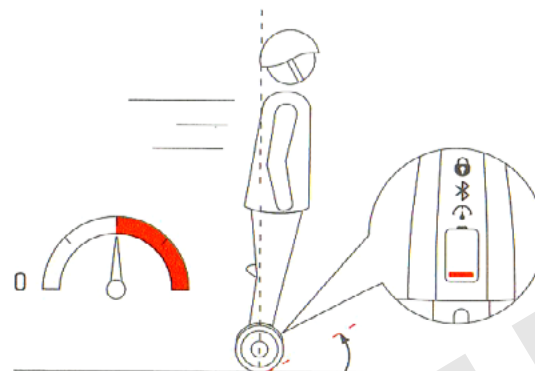

 It is forbidden to travel on Mini on the road for cars or ride in a residential area with a large flow of passers-by.



 If you exceed the speed limit or if the battery level of segway is too low, foot is lifted smoothly and you will hear an audible alarm, after which a significant acceleration of segway is prohibited.



 It is forbidden to ride through the puddles, the depth of which is greater than 2 cm.

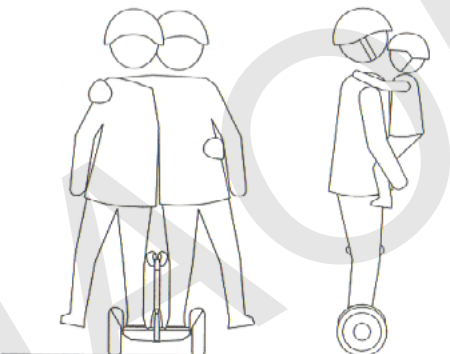

 It is forbidden to ride on the Mini for more than one person, or to hold baby in your arms.

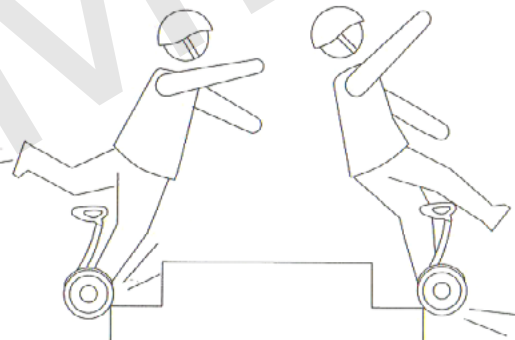

 It is forbidden to ride a Segway on stairs or escalator.

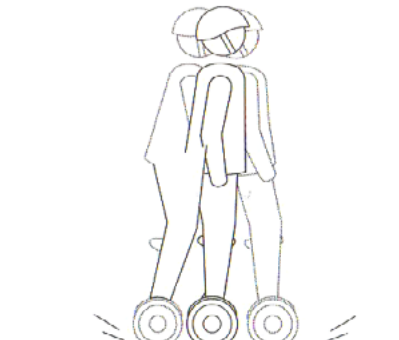

 It is forbidden to rapidly accelerate. It is forbidden to swing on Segway forward - backward.

9. Transport and energy saving mode

If you need to move turned on Segway, lift it, taking the handle of the steering rack.

Here, for your safety, Mini will automatically shut down, and when you put it back on the ground – it will automatically activate.

There is no need to raise the Segway, holding his fenders and his case, because during such transportation, wheels can turn, and the clothes or fingers can be caught in the opening between the tire and the fender, which in turn, will lead to serious injury.

See images above.

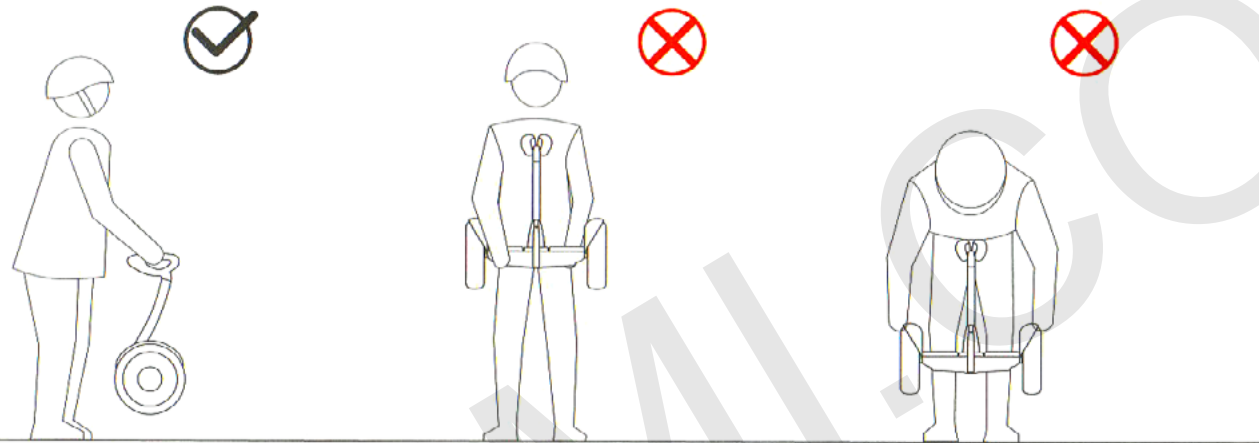

If you are not using segway, and he at the same time is in the ON mode, Mini can automatically switch to power saving mode. In this mode, you can roll a Segway, if you want to climb the ladder - lift the Mini, but in no case do not roll it up the stairs.

See images above.



10. Safety recommendations

- Mini - a device for entertainment, not a vehicle.

But as soon as you only once to appear with it in a public place, you will immediately notice the characteristics of the vehicle, which is why we can talk about the presence of risk for your safety.

For the sake of your own safety and the safety of others, you must always to follow strict guidelines set forth in this riding manual.

- At the same time you have to understand that if you enter on a Segway in public places, you must comply with all the recommendations on safety.

Also do not forget that there is a probability of collision due to violation of traffic rules by drivers of vehicles or pedestrians there is also a risk of injury due to improper use of the device.

As in other forms of transport, the higher speed of Mini, the greater the braking distance. On some flat surfaces, emergency braking can cause skidding of segway, loss of balance and even fall.

Therefore, while operating segway, you must be vigilant, stick to the appropriate speed, keep a safe distance from pedestrians or other vehicles. Riding in an unfamiliar area, be vigilant and follow appropriate speed.

- When riding on a Segway, respect the rights of pedestrians. Do not scare passers-by, especially children.

Reduce speed of segway when passing near the passers-by. If you are moving in the same direction with the passers-by, as much as possible, try to keep to the left (for countries with right-hand traffic). If you move in the opposite direction, keep the right and slow down.

- At the moment, in some countries there is no national standard or law on driving self-balancing electric scooter, so you should strictly follow

the outlined in these instructions, rules and guidelines for safety.

Violation of the above rules may result in financial expenses, personal injury, accident, legal disputes and other conflicts and unpleasant affairs. Xiaomi and Ninebot Company do not bear any direct or shared responsibility.

- To prevent personal injury, do not pass Segway Mini on to other persons, who do not know how to ride it.

For the safety of your friend, before giving him a ride on a Segway, open the app App for him and turn mode for beginners, so he can complete the training and also watched video instruction on safe riding.

Do not forget to inform him about the need to wear protective equipment and helmet. To help him learn how to ride a vehicle, you can scan the QR-code shown on the pads of the steering rack, to download a video for safe riding.

- Before each use of segway carefully inspect and test it. If you find shattered parts, battery life has decreased considerably, tires leak air or have an excessive wear, uncharacteristic noises when turning on or other abnormal symptoms, stop using segway immediately.

Log in to the App, recognise problems, and call Technical Support and get a specialized and expert advice and, if necessary, warranty service.

11. Maintenance and Storage

Cleaning and Storing Mini

If you find any stains on the case of Mini, take a piece of soft cloth moistened with a little bit of water, and wipe the vehicle; if you spotted stains that are difficult to remove, you can use toothpaste and a toothbrush to clean spots on the Segway, and then wipe it clean with a damp cloth.

If you find scratches on parts made from plastic, you can use sandpaper or other abrasives to polish them.

Warning: Do not use alcohol, petrol, kerosene or other corrosive solutions, volatile chemical solvents for cleaning, otherwise, it will cause serious damage to the case and can disrupt segway interior construction.

Do not wash the Mini under the strong pressure of the water, even if the Segway is turned off. In addition, after charging of the vehicle, it is necessary to insert back the rubber cap, otherwise you may get an electric shock or in a result of flowing of water into this hole may cause serious damage.

If you do not use segway, store it in a cool, dry place, and do not leave it for long-term stay on the street. Leaving the device under the sun / in extremely high temperature / over-low temperature can cause rapid aging of the outer case and wheels of Mini or to reduce the battery life.

Maintaining Battery Mini

Do not store the battery of segway in rooms with the temperature, which exceeds 50C or below -20C (for example, do not leave the battery Mini and other batteries in cars in summer time under the scorching sun).

Do not place the battery near the fire, because the consequences of such actions can deteriorate the battery, overheat and even a risk of fire. The other technical support information and precautions, see under the body of the device on the tech plate of the battery.

Avoid complete discharge of device, it will help extend the life of the battery.

Furthermore, when using the device at room temperature, the battery is able to overcome a much greater distance and its performance will be better; but if you use a Segway at temperatures below 0C, performance and cross-country of vehicle decreases.

At -20C, distance traveled by segway will be smaller by half than in normal conditions or even less. But when the temperature rises, the distance traveled by the battery again will be the same, go to the App and check the remaining distance.

Note: A fully charged segway lasts for about 120-180 days of standby time; not fully charged Segway lasts for about 30-60 days in standby.

Therefore, if you did not promptly charged device excessively low charge may cause damage to segway.

Such damage can not be restored.

The battery has a smart chip that stores information about its charging-discharging, so if you're in for a long time not to recharge the Segway it can cause a serious damage to the device after which can not be recharged, thus, this type of damage is not included in the free warranty service.

(Warning: Unauthorized persons are forbidden to disassemble the device, as there is a risk of electric shock or other serious injury due to a short circuit).

12. Table of device parameters

Performance parameters	Name	N3M240 parameters
Size	Length x width (mm)	260x548
	Height of the body [1] (mm)	595
Quality	Maximum load (kg)	85
	Device weight (kg)	about 12.8
Requirements for Segway ride	Suitable age	16-50
	Suitable height (cm)	120-200
Most important parameters	Maximum speed (km/h)	about 16
	Permeability in normal conditions [2] (km)	about 22
	Gradeability	about 15 ⁰
	Mode for beginner	There is, after the required run 1km for beginner, feature is automatically turned off. You can then re-enter the App and resume training for a beginner.
	Suitable terrain	Solid road surface, smooth clay surface, road with a maximum slope of 15 ⁰ , the depth of pools no more than 2cm,
	Operating temperature range	-10 ⁰ C +40 ⁰ C
	Storage temperature	-20 ⁰ C +45 ⁰ C
	level of water resistance	IP54 (Waterproof, with a small possibility of using during rain)
Battery parameters	Battery Voltage (V)	54.8

	maximum voltage charge (V)	63
	Rated power (W)	236
	Smart BMS	Balancing, recharge, undervoltage, automatic disconnection if you overheat, battery monitoring applications using App
Engine parameters	Rated power (W)	350x2
	Maximum power (W)	700x2
	Legalization	CCC,CE
Charger Options	Rated Power (W)	70
	Rated input voltage (V)	100-240V-50-60Hz
	Nominal output voltage (V)	about 63
	Rated current (A)	about 1.1
	Legalization	CCC,CE,FCC,PSE,UL,SAA
	Charging time (h)	about 4

[1] Case height: the distance from the ground to the highest point of segway. [2] Permeability in normal conditions: with maximum battery charge, 70kg load, temperature of 25°C, at an average speed of 15 km / h on a flat road

Please note: data and parameters may vary between models. Subject to change without notice.

13. The presence of toxic and hazardous substances

Name	Toxic and hazardous substances and elements					
	Pb	Hg	Cd	Cr6+	PBB	PBDE
Case	0	0	0	0	0	0
Display	X	X	0	0	0	0
LED	X	0	0	0	0	0
Control lever	X	0	0	0	0	0
Body	0	0	0	0	0	0
Battery	0	0	0	0	0	0
Engine	0	0	0	0	0	0
Charger	x	0	0	0	0	0

0: toxic and harmful substances in all components of the device contained in an amount below the limit value according to SJ / T11363-2006 «requirements limiting the presence of toxic and hazardous substances in products.»

X: indicates the presence of toxic and hazardous substances at least one of the components in this product in excess of the limit value, according to SJ / T11363-2006 «requirements limiting the presence of toxic and hazardous substances in products.»

14. Trademark and Legal Notices

Mini TM, TM Ninebot, self-balancing electric scooter Nine - is a registered trademark of LLC «Ninebot Technology» (Beijing) (hereinafter referred to as the company Ninebot or Ninebot Inc.).

Trademarks «Mini», «Ninebot TM,» «self-balancing electric scooter Nine», «Trademark 9TM» are registered trademarks of Ninebot. Other trademarks and trade names mentioned in this document are the property of their respective owners.

The company has a patented Ninebot serial devices Mini Segway. This manual is protected by copyright Ninebot company.

Any organizations or individuals shall not without the written permission of the patent holder voluntarily use, produce, disseminate these patents.

This guide contains information to familiarize themselves with the various functions and instructions for use. But due to continuous updates, design changes, and so on, you may find some differences between the previously acquired devices and new models.

Please scan shown in the fourth page, QR-code, download the App on the smart phone with Android system or iOS, and read the latest electronic edition of the operating instructions.

In addition to the model Mini, Ninebot is also the creator and owner of many different functions and models. Some features mentioned in this guide may not be supported by other devices Ninebot.

Due to the continuous updates of device between this manual and the device may be some variations in color, appearance and other aspects, but a particular device takes precedence.

Manufacturer

LLC «Ninebot (Changzhou) Technology»

Address: Changzhou, district Wujin, 18 Changwuzhong Street, Educational Scientific Research Center Changzhou, 3, building A, apartment 16, floor 17
LLC «Ninebot (Tianjin) Technology»

Address: Tianjin, district Wuqing, 11 Qiche Chanye Yuantianrui street,
Standard: Q / 320412NCZ001-2015

15. Warranty

Warranty

- Within 7 days from the date of purchase, in the event of a problem, if it is not caused by the human factor, technical service Xiaomi determines cause of the problem, then you can choose a free product replacement, return or repair.
- Return of goods is only possible through the main shops of Xiaomi and only within 7 days after purchase. You can not take the opportunity to return the product without reason within seven days after the purchase, in the event of damage to the goods incurred due to the human factor, or in the case of damage to the packaging. When you return goods without reason, within seven days after purchase, all shipping costs borne by the consumer.
- Within 8-15 days from the date of purchase, in the event of a problem, if it is not caused by the human factor, you choose a free replacement or repair of goods, gifts or free samples of the goods can not be replaced or refunded.
- The guarantee shall enter into force upon signature by the buyer warranty card. If it is impossible to set a date for signing the warranty card, warranty repair is carried out according to the order number to the official website and the invoice.
- Terms of warranty of the main device and its components:

Description	Information on warranty maintenance	Term
Main device	body assembly, controller, hub motor, internal circuit board / instrument panel, shaft (blank) / roller (pressing member) / linear Hall sensor	1 year
Battery and charger	External Battery Charger, battery assembled	6 months
Appearance of easily wear parts	Tires, wheels, fenders and firming unit, the outer covering of the body/ buttons/ front, middle and back cover / screw plug, front and rear facing, footrest, pedals and the mat	3 months
Hardware	Elongate air vent	15 days

Conditions under which warranty service is not possible

Under conditions that are not included in the warranty service and maintenance is carried out on a fee basis:

- warranty period has expired;
- failure of the device, which have arisen due to the human factor;
- Damage caused by force majeure;
- damage caused by improper storage or improper use of the device, set out in the regulations;
- violation of the conditions of normal use of the device, causing any damage to or failure of this device, such as overload, riding over obstacles (including, but not limited to - Riding the stairs, falling, etc.), extreme riding;
- repair of the device by unauthorized service centers or dismantling;
- deliberate damage to the warranty card, in particular its content - information about the vehicle, including the blurring of the recording gap, content correction, etc .;
- Other damage or damage not related to production, structure, design and quality of the device;
- vehicle mileage exceeds 2000km;
- If this product is used for commercial purposes, all warranty conditions are not saved.

Note:

Within 7 days from the date of signing the purchase and the warranty card, in the event of a problem, if it is not caused by the human factor, the buyer can choose a free product replacement , return or repair. Company Xaiomi and service-provider company Xiaomi provides an opportunity to use the service with home arrival. In case of return the item within 7 days, an amount that corresponds to the paid shall be returned according to the bill.

Return of goods is only possible through the main shops Xiaomi the official website or official website Tmall and only within 7 days after purchase. When you return goods without reason, within seven days after purchase,

all shipping costs borne by the consumer (with return of purchase, payment for travel expenses will not be returned).

Return goods within 7 days after the purchase is not possible in the case: goods for damage incurred due to the human factor, package is damaged, absence of any component. Information about returns submitted on the official website of the company Xiaomi, shall prevail.

Return and replacement of goods

Name	Deadline	Return type and replacement of goods	Detailed description	Term
Return Policy	7 days	National legislation on the functionality of the device and its quality	Authorized service provider company Xiaomi checks the device outputs and gives test report, which indicates that the cause of the problem is the quality of the good.	From the moment the user has received product
Replacement	15 days	National legislation on the functionality of the device and its quality	Authorized service provider company Xiaomi checks the device outputs and gives test report, which indicates that the cause of the problem is the quality of the good.	From the moment the user has received product

16. Maintenance service

During use of Mini, if you have any questions about riding device, its maintenance, safety, you can visit site Xiaomi where you will find information on warranty and get advice.

This device can be technically updated or firmware updated, whereby there may be some inconsistencies with the information in the instruction. If you want to get information about the latest features or safety instructions, load the custom application App Ninebot, electronic manual which shall prevail.

You can also go to the appropriate forums or communities Xiaomi on the official website forums Ninebot.

www.ninebot.cn

XIAOMI-MI.COM