

# Parrot

## BEBOP DRONE



User guide



# Table of Contents

<b>Before you begin</b> .....	<b>4</b>
Package contents.....	4
Downloading the application.....	4
Charging the battery.....	4
Installing the battery.....	5
Using the hull.....	5
Connecting a smartphone.....	6
Switching on/off the Parrot Bebop Drone.....	6
Changing the propellers.....	7
<b>Preflight check</b> .....	<b>8</b>
<b>Flying</b> .....	<b>9</b>
Piloting screen.....	10
Calibrating the Parrot Bebop Drone.....	11
Map mode.....	11
Flat trim.....	13
GPS signal .....	13
Take off.....	13
Movements.....	13
Pre-programmed acrobatics.....	15
Photos and videos.....	15
Landing.....	17
Return to starting point.....	17
Battery.....	19
<b>Settings</b> .....	<b>20</b>
Flight.....	20
Image.....	20
Recording.....	21
Piloting.....	22
Network.....	23
Motor information.....	25
Version.....	25

Drone Academy.....26

Updating.....28

Troubleshooting.....29

    Led behavior.....29

    Spare parts.....29

General information.....30

    Safety precautions and maintenance.....30

    Wi-Fi.....31

    Warning on invasion of privacy .....31

    Battery.....31

    Warranty.....31

    Modifications.....32

    Disposal of this product at the end of its life .....33

    Declaration of conformity.....33

    Registered trademarks .....33

# Before you begin

Note: For easy reading, iPhone®, iPad® and other compatible telephones or tablets are referred to as 'smartphones' in the manual.

## Package contents

Parrot Bebop Drone	Batteries (x 2)
Extra propellers (x 4)	Propellers mounting tool
Charger	Plug converters (x 4)
Lens cap	USB / Micro USB cable
Hull protections (x 2)	

Install the camera's lens cap with the elastic band when you carry the Parrot Bebop Drone to protect it.

## Downloading the application

Connect to the App Store<sup>SM</sup> or Google Play<sup>TM</sup> and download the **FreeFlight 3** application for free.

Note: The application is compatible with the Parrot Bebop Drone from the FreeFlight 3.1 version only.

## Charging the battery

1. Insert the plug converter corresponding to your country to the charger.
2. Plug the battery into the charger.
3. Plug the charger into the mains.
  - > The charger led lights up in red when charging. Once the battery is fully charged, the led turns green. The battery takes about 1 hour to charge.

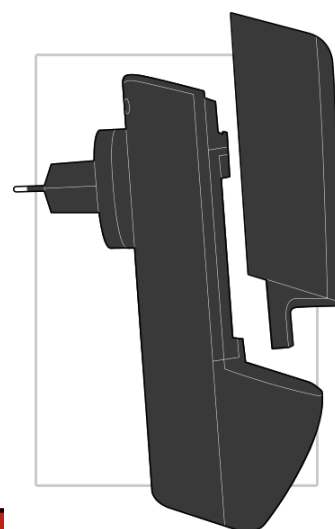

## Installing the battery

1. Plug the battery to the Parrot Bebop Drone's power cable (A). If necessary, pull the string to access the power cable.
2. Slide the battery into its compartment.
3. Attach the strap to secure the battery (B).

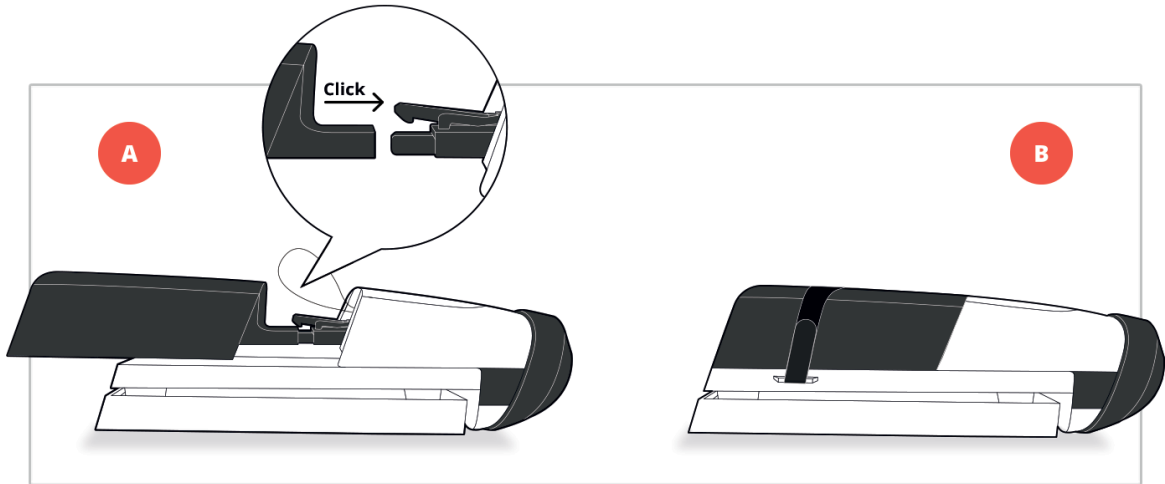

## Using the hull

To use the Parrot Bebop Drone indoors:

1. Install the hull protectors to protect the Parrot Bebop Drone in case of collision.
2. Launch the FreeFlight 3 application.
3. Press , then **Flight settings**.
4. Activate the **Hull** button.

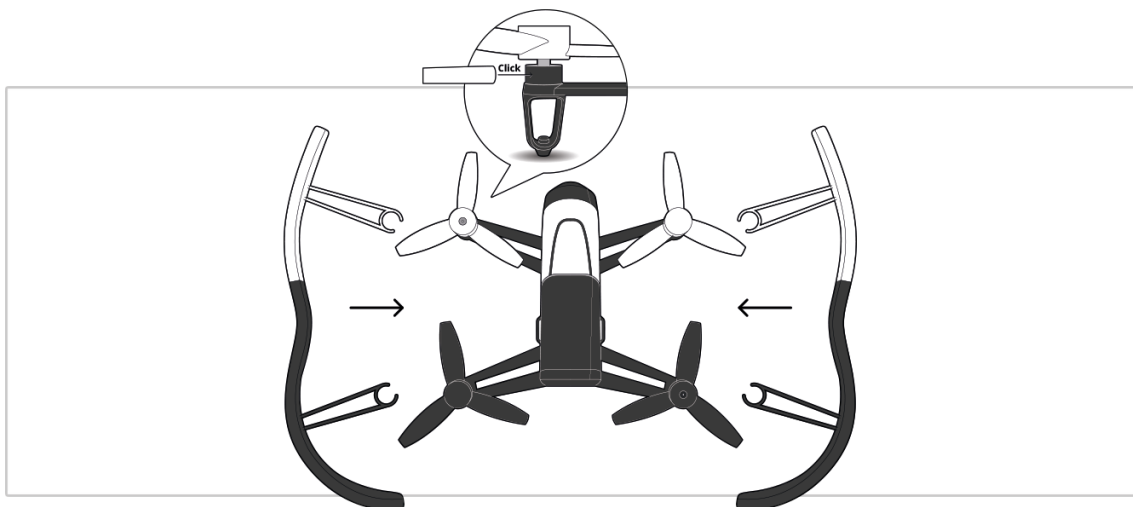

To use the Parrot Bebop Drone outdoors:

1. Remove the hull protectors for better speed performance.
2. Press , then **Flight settings**.
3. Deactivate the **Hull** button.

Note: If you fly the Parrot Bebop Drone outdoors in an obstructed area, install the hull protectors and activate the Hull button.

## Connecting a smartphone

1. Switch the Parrot Bebop Drone on.
2. On your smartphone, launch a search of the Wi-Fi® networks available:
  - if you are using an iPhone or an iPad, select **Settings > Wi-Fi**;
  - if you are using an Android™ smartphone, select **Settings > Wireless and networks > Wi-Fi**.
3. Select the network: BebopDrone\_XXXXX.
4. Wait for your smartphone to connect to the Wi-Fi network of the Parrot Bebop Drone. This connection is generally represented by the Wi-Fi logo appearing on the smartphone screen.
5. Start the FreeFlight 3 application.
  - > The connection between your smartphone and the Parrot Bebop Drone is established automatically.

See the [Settings > Wi-Fi](#) section for further information.

## Switching on/off the Parrot Bebop Drone

Press the on/off button located on the back of the Parrot Bebop Drone to switch it on or off.

> The led located on the on/off button lights up in green and the Parrot Bebop Drone emits a sound once it is fully booted and ready for use.

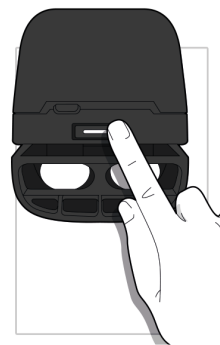

## Changing the propellers

1. Remove the propellers with the propellers mounting tool (A).
2. Install the new propellers (B):
  - place the propellers with a hole in the middle on the motors with a protruding axle (front right and rear left motors);
  - place the propellers without a hole on the motors without protruding axle (front left and rear right motors).
3. Lock the propellers with the propellers mounting tool.

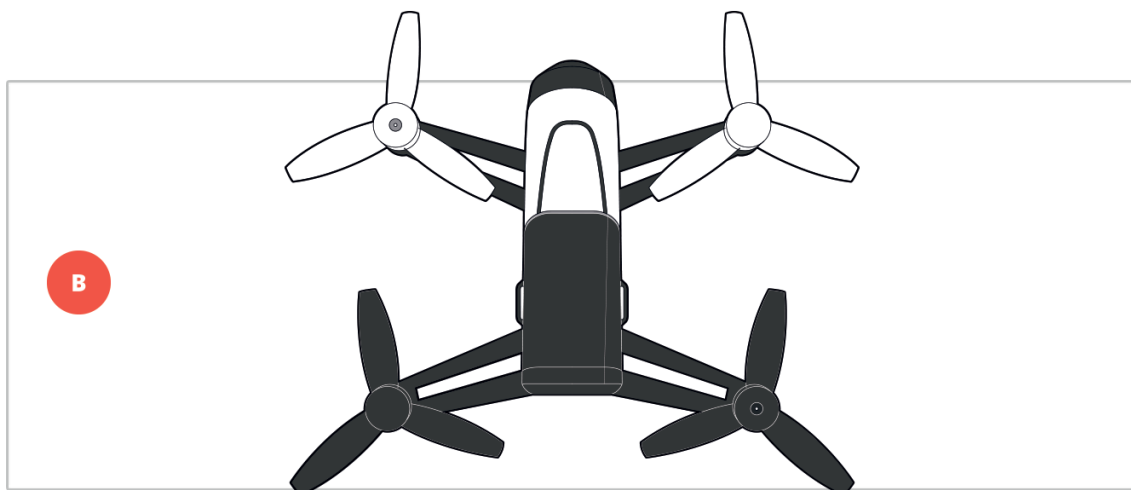
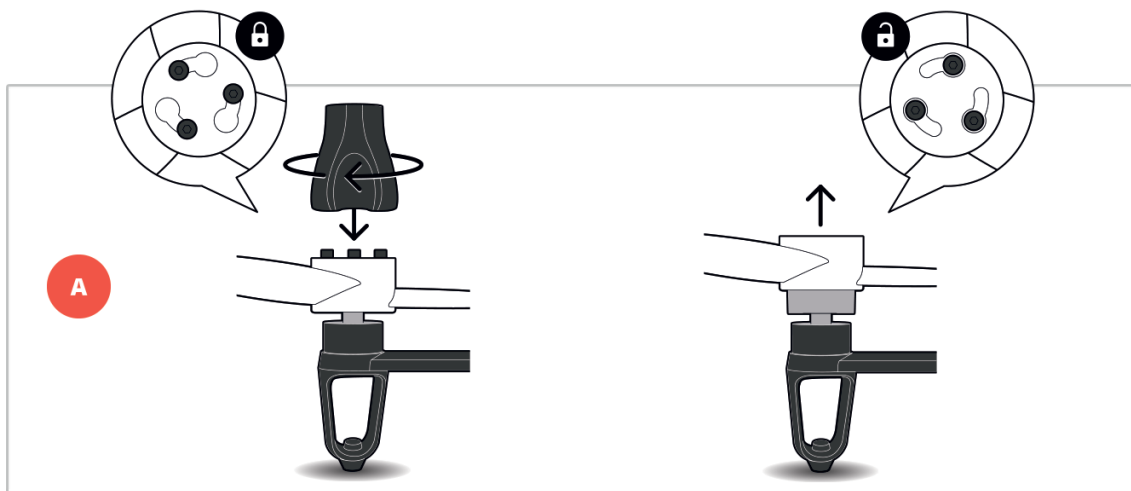

# Preflight check

Before each flight session, check the following points:

- Do not fly the Parrot Bebop Drone at night.
- Check the weather conditions. Do not fly the Parrot Bebop Drone when the weather is rainy, snowy, or foggy.
- Ensure there is no obstacle in your flight area that could disturb piloting or visual flight.
- Ensure the use of the Parrot Bebop Drone is allowed in your flight area.
- Check the Wi-Fi use restrictions in your flight area.
- Ensure the propellers are correctly installed and locked. For further information, see [Before you begin > Changing the propellers](#).
- Ensure the battery is correctly attached to the Parrot Bebop Drone. For further information, see [Before you begin > Installing the battery](#).
- Ensure the Parrot Bebop Drone and your smartphone batteries are charged.
- Check the quality of the Wi-Fi range. For further information, see [Settings > Wi-Fi](#).



# Flying

Note : Normal piloting mode is activated by default. To change mode, see [Settings>Piloting](#).

1. Launch the FreeFlight 3 application.
2. Wait until the connection between your smartphone and the Parrot Bebop Drone is complete.
3. Press **Start** to pilot the Parrot Bebop Drone.
  - > The piloting screen appears. It locks in landscape format.

## Piloting screen



#	Description	#	Description
1	Last screen	9	<a href="#">Left joystick</a>
2	<a href="#">Settings</a>	10	<a href="#">Right joystick</a>
3	<a href="#">Flat Trim</a>	11	Speed
4	<a href="#">Emergency landing</a>	12	Altitude
5	<a href="#">Pre-programmed acrobatics</a>	13	Distance from your smartphone
6	<a href="#">Video recording</a>	14	<a href="#">Take off</a>
7	<a href="#">Photo</a>	15	GPS signal
8	<a href="#">Map mode</a>	16	<a href="#">Battery level</a> of the Parrot Bebop Drone

## Calibrating the Parrot Bebop Drone

When you use the Parrot Bebop Drone for the first time, the calibration screen appears.

1. Follow the procedures on the screen.
2. Once you completed the three steps, press **<**.

Note: You can also calibrate your Parrot Bebop Drone if it does not stay on course correctly. To do so, press **⚙️**>Flight settings.

## Map mode

You can display a map instead of the camera video feedback to see the position of your Parrot Bebop Drone.

Before activating the map mode:

- preload a map. If you fly the Parrot Bebop Drone in an area without internet connection, or if the internet connection is lost while flying, the Parrot Bebop Drone will still be located on the map.
- wait until the **(G)** icon turns green to indicate the Parrot Bebop Drone GPS position is detected.

Preloading a map

1. Go to the main screen of FreeFlight 3.
2. Press **☰** > **Settings**.
3. Press **Preload a map**.
  - > The map appears. The blue dot indicates your position.

Note: To locate your position on the map, the FreeFlight 3 application must have access to your smartphone location services. For iOS devices, activate the function in Settings > FreeFlight 3 > Location service. For Android devices, activate the function in Settings > Application manager > FreeFlight 3 > Permissions. For further information, see your smartphone user guide.

4. Zoom in your flight area. If you already are in your flight area, press **Center on your location**, then zoom.

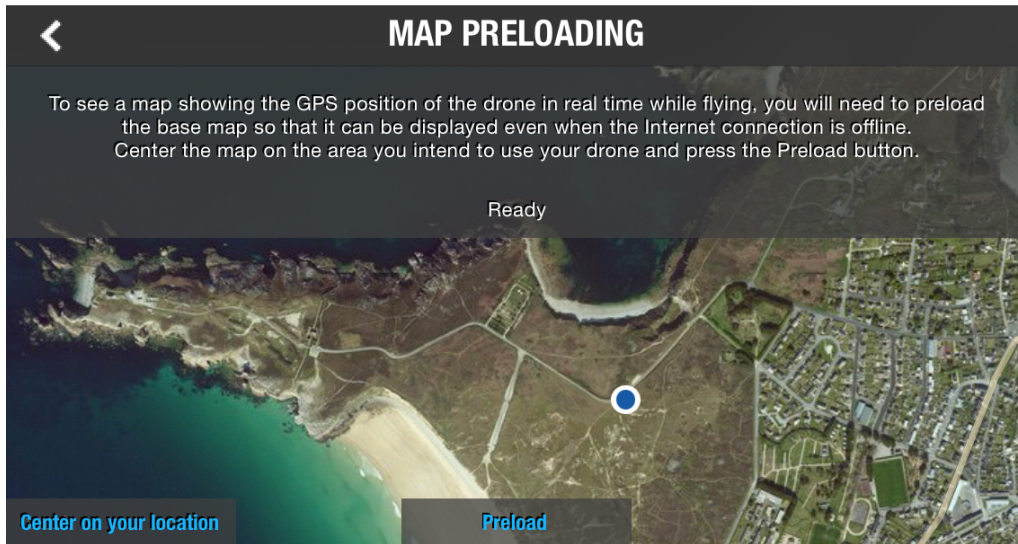

5. Press **Preload**.
6. Wait until the preloading is completed.

Activating map mode

Press .

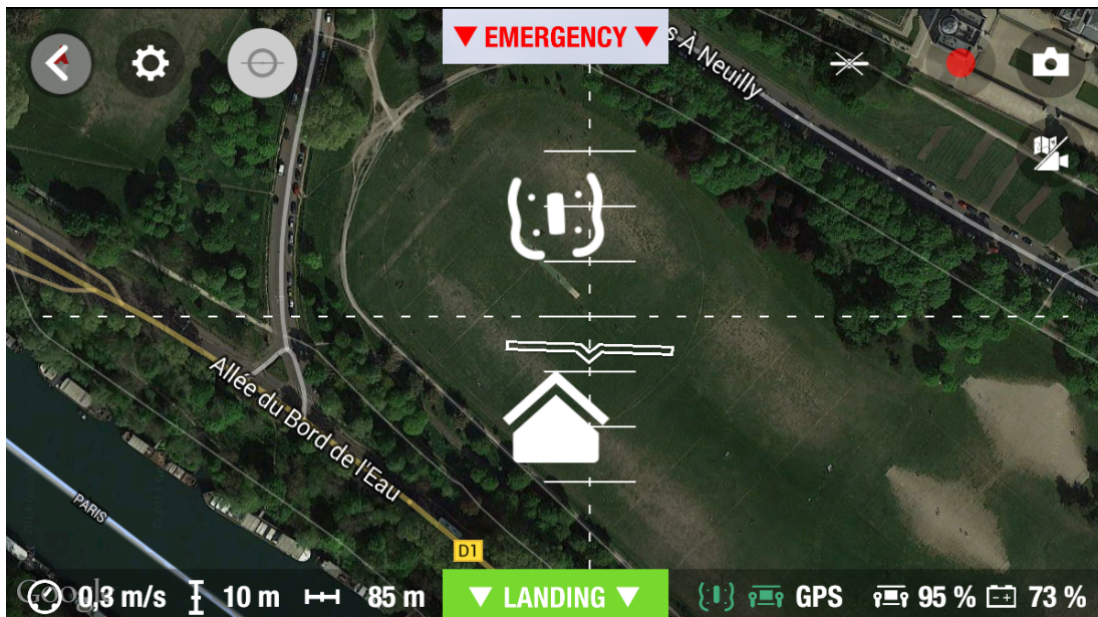

The  icon indicates the Parrot Bebop Drone starting point.

The  icon indicates the Parrot Bebop Drone position.

To switch back to the video mode, press  again.

## Flat trim

Use the flat trim feature after you change the battery or if the Parrot Bebop Drone does not stay on course correctly.

1. Place the Parrot Bebop Drone on a flat, dry, unobstructed surface.
2. Press .

## GPS signal

Note: If you are in an area with no GPS reception, the Parrot Bebop Drone position will not be detected.

The  icon indicates that the Parrot Bebop Drone position is detected.

The  icon indicates that the Parrot Bebop Drone position is not detected.

Make sure the Parrot Bebop Drone position is detected before taking off to register the starting point correctly.

## Take off

1. Place the Parrot Bebop Drone on a flat and dry surface and in a unobstructed and lit area.
2. Press **Take Off**.
  - > The Parrot Bebop Drone takes off and hovers at approximately 1 m above the ground.

## Movements

Note: Movements depend on the flight and piloting settings. See the [Settings](#) section for further information. The following description is valid when the Normal option is activated and Joypad inverted option is deactivated (default configuration).

## Right joystick:

Hold the central button and tilt your smartphone forwards or backwards to pilot the Parrot Bebop Drone forwards or backwards.

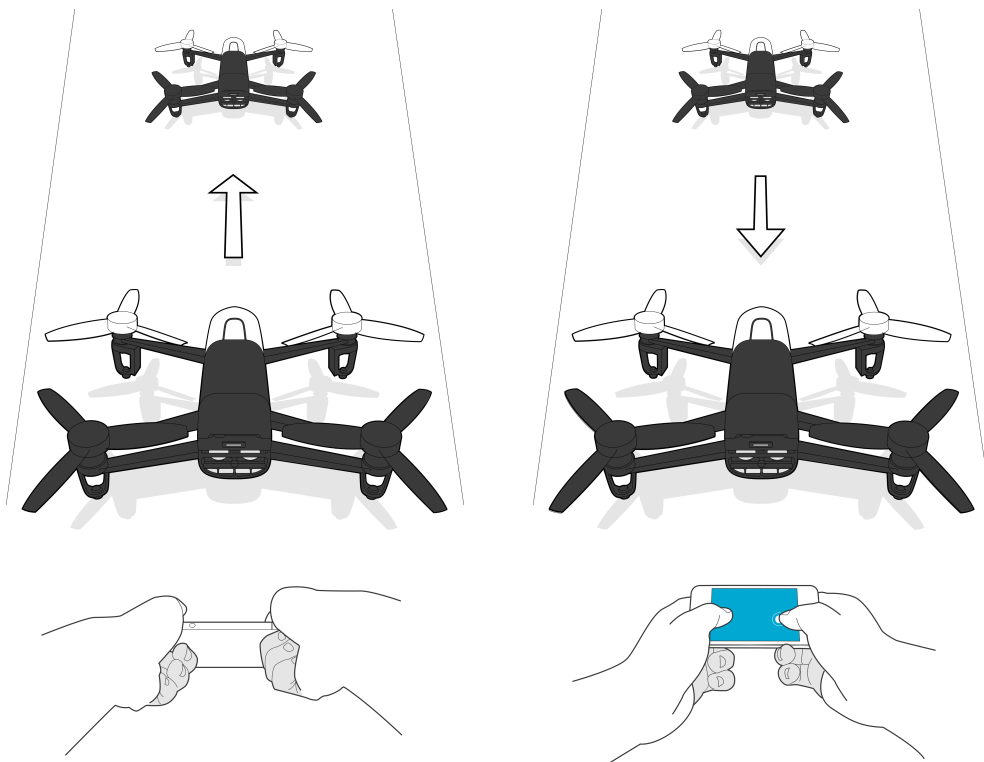

Hold the central button and tilt your smartphone to the left or right to fly the Parrot Bebop Drone to the left or right.

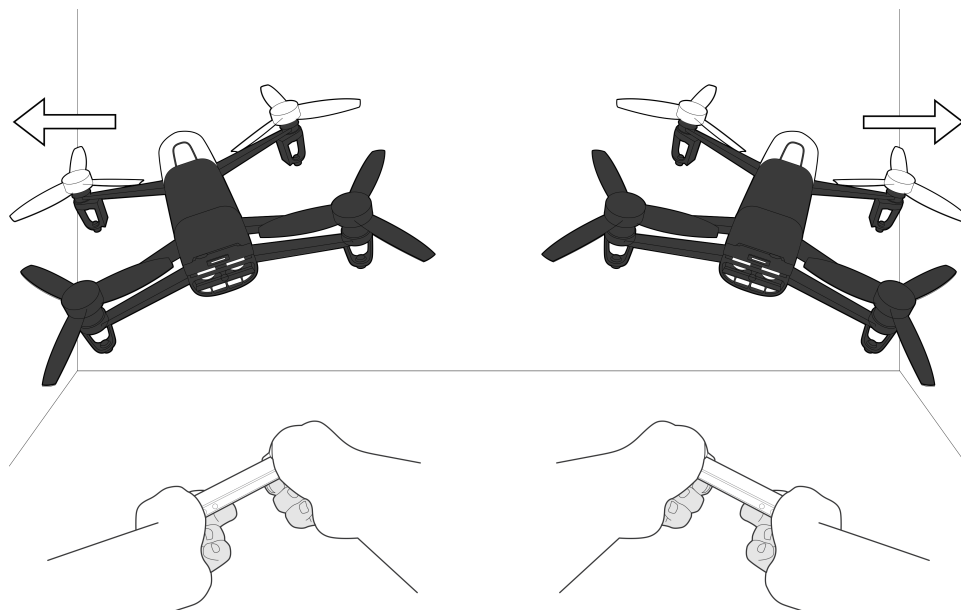

Left joystick:

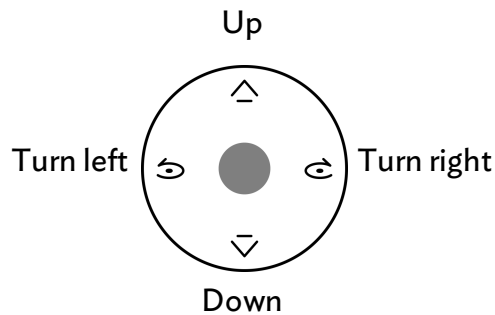





## Pre-programmed acrobatics

The Parrot Bebop Drone can perform acrobatics while flying, whether it is stationary or moving.

1. Press the flip icon to change the flip.  is selected by default.

---

	back flip
	front flip
	left flip
	right flip
	no flip

---

2. Tap on your smartphone screen twice to perform a flip.

## Photos and videos

Note: The camera is located at the front on the Parrot Bebop Drone. The camera located under the Parrot Bebop Drone is for stabilization only. You can set the Parrot Bebop Drone in video or photo mode. The video mode is activated by default. For further information, see [Settings>Recording](#).

### Orienting the camera

Control the angle of the camera regardless of the Parrot Bebop Drone position.

- in **Normal** and **Joypad** modes : slide two fingers on the screen.

Note : The vertical orientation commands are reversed. If you slide your finger upwards, the camera angle will move downwards. If you slide your finger downwards,

the camera angle will move upwards.

- in **Ace** mode : slide .

### Taking a photo

Press  to take a photo.

The internal memory of the Parrot Bebop Drone is 8GB. The maximum number of photos stored in the internal memory depends on the selected format. To choose a photo format, see [Settings>Recording](#). Once the memory is full, it is no longer possible to take a photo.

Note: To obtain high quality photos, ensure that the Parrot Bebop Drone is set in photo mode. To do so, see [Settings>Recording](#).

### Recording a video

The video recording starts automatically when you press **Take off**. The  button blinks during recording.



To stop the video record, press . To start a new video, press  again.

Note: It is not possible to record a video when the Parrot Bebop Drone is set in timelapse mode. To deactivate timelapse mode, see [Settings>Recording](#).

Note: The video recording stops after 25 minutes of recording.

### Retrieving photos and videos

To retrieve photos and videos from the FreeFlight 3 application:

1. Press  to return to the main screen.
2. Press  to display the contextual menu.
3. Press **Internal memory**.
  - > The list of photos and videos stored in the Parrot Bebop Drone internal memory appears.
4. Select one or several photos and/or videos.
5. Press **Transfer** to retrieve the photos and/or videos on your smartphone.
6. Press **Delete** if you want to delete the photos and/or videos from the internal memory of the Parrot Bebop Drone.

To retrieve photos and/or videos on your computer:

Note: Before connecting the Parrot Bebop Drone to your computer, ensure that the Parrot Bebop Drone battery is installed and charged.

1. Connect the Parrot Bebop Drone to your computer with the USB/micro USB cable (supplied).



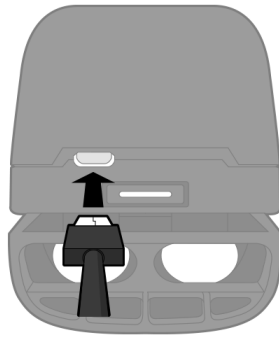

2. Switch the Parrot Bebop Drone on.
  - > Your computer detects the Parrot Bebop Drone automatically. Wait until the driver installation is complete. A pop-up appears like the one shown below.

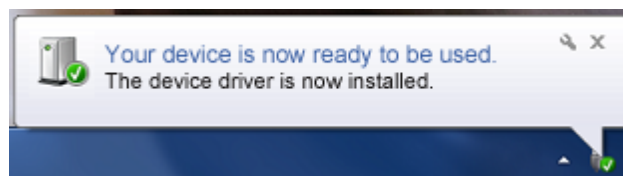

The appearance, content and location of this message will depend on your operating system.

3. Open the file, as though it were a USB flash drive.
  - > You can copy the photos and/or videos on your computer.

Note : It is not possible to transfer video files to the Parrot Bebop Drone.

## Landing

Ensure that the Parrot Bebop Drone is over a flat, dry and unobstructed surface, then press **Landing** to make the Parrot Bebop Drone land.

Press **Emergency** in an emergency case only. The motors will cut out and the Parrot Bebop Drone will immediately drop from the height at which it is flying. Using the landing button is sufficient in most instances.

## Return to starting point

Note: If neither your smartphone nor the Parrot Bebop Drone receives a GPS signal, the Return to starting point feature cannot be activated.

The **Return to starting point** feature enables you to make the Parrot Bebop Drone fly back to:

- the last take off location,
- your smartphone location if the Parrot Bebop Drone has received no GPS signal.

Note: To locate your position on the map, the FreeFlight 3 application must have access to your smartphone location services. For iOS devices, activate the function in

Settings > FreeFlight 3 > Location service. For Android devices, activate the function in Settings > Application manager > FreeFlight 3 > Permissions. For further information, see your smartphone user guide.

### Displaying the starting point

Press .

> Map mode is activated. The  icon indicates the position of the Parrot Bebop Drone starting point. If the Parrot Bebop Drone has received no GPS signal, the starting point does not appear.

### Flying the Parrot Bebop Drone back to its starting point

1. Press .

> The **Return to starting point** screen appears.

1. Press .

> The  button turns green and the Parrot Bebop Drone returns to its starting point. Once the Parrot Bebop Drone reaches its starting point, it remains at 2 m above the ground.



You can take control over the Parrot Bebop Drone when it is returning to its starting point.

Note: If the Parrot Bebop Drone altitude is below 10 m, it will reach an altitude of 10 m before returning to its starting point in order to avoid any obstacle.

Note: If the connection between your smartphone and the Parrot Bebop Drone is lost, the Parrot Bebop Drone returns to its starting point automatically after 1 min of disconnection.

## Battery

The  button indicates the Parrot Bebop Drone's battery level. The Parrot Bebop Drone has a battery life of approximately 11 minutes.

When the battery level is low, an alert appears on your smartphone screen. The Parrot Bebop Drone's on/off button turns red.

Note: The number of acrobatics can have an impact on the Parrot Bebop Drone's battery life.

# Settings

Press  to access the Parrot Bebop Drone settings menu.

Slide the screen right or left to access the different settings screens.

Press  to reset the Parrot Bebop Drone to factory settings. It will delete your settings and preferences, photos and videos stored in the Parrot Bebop Drone's internal memory.

Note: You can also reset the Parrot Bebop Drone without the Parrot Bebop Drone application. To do so, switch the Parrot Bebop Drone on and press the on/off button for 10 seconds. The led blinks green and orange, then turns green. The Parrot Bebop Drone switches off automatically.

## Flight

Select the **Flight settings** screen.

Activate the **Hull** button when the hull protections are installed.

Press **Calibrate** when the Parrot Bebop Drone does not stay on course correctly.

To set the speed:

- Use the **Max vertical speed** option to define a maximum speed when you fly the Parrot Bebop Drone upwards.
- Use the **Max rotation speed** option to define a maximum speed when you make the Parrot Bebop Drone rotate.

When you fly the Parrot Bebop Drone horizontally, its speed depends on the angle of inclination.

Note: The hull protections slow the Parrot Bebop Drone down when you fly it outdoor.

## Image





Select the **Image settings** screen.

Press  to set the image contrast.

Press  to set the image exposure.

Select one of the following buttons to adapt the white balance according to your environment:

---

	automatic
	daylight
	cloudy
	white fluorescent light
	tungsten bulb

---

## Recording

Select the **Recording settings** screen.

The Parrot Bebop Drone is equipped with a fisheye (wide-angle) camera.

Note: The camera lens is situated at the front of the Parrot Bebop Drone. The lens situated under the Parrot Bebop Drone is for stabilization only.

Press **Photo mode** or **Video mode** to select video or photo mode.

Note: The video mode is activated by default.

Press **DNG** (high resolution photos) or **JPEG** to select a photo format.

To activate burst mode:

1. Press **Timelapse mode**.
2. Slide your finger on the circle to select the interval between each photo. If you select 10", the Parrot Bebop Drone will take a picture every 10 seconds.

Note: When the Parrot Bebop Drone is set in timelapse mode, it is not possible to record a video.

Note : When the DNG option is activated, the timelapse mode enables the Parrot Bebop Drone to take a picture every 10 seconds minimum. When the JPEG option is activated, the timelapse mode enables the Parrot Bebop Drone to take a picture every 8 seconds minimum.

## Piloting

Select the **Piloting settings** screen.

Use the **Max altitude** option to define a maximum altitude when you fly the Parrot Bebop Drone upwards. When the Parrot Bebop Drone is about to reach this limitation, it stabilizes at the altitude selected.

Use the **Max inclination** option to define a maximum angle pitch when you fly the Parrot Bebop Drone forwards and backwards. The lower the maximum inclination value, the smaller the angle of pitch. The higher the maximum inclination value, the greater the angle of pitch.

Note: This setting affects the acceleration. With a greater angle of pitch, the Parrot Bebop Drone will accelerate faster.

The left handed option reverses the controls on your smartphone. To do so, press **Joypad inverted**.

Three piloting modes are available:

### Normal

(activated by default)

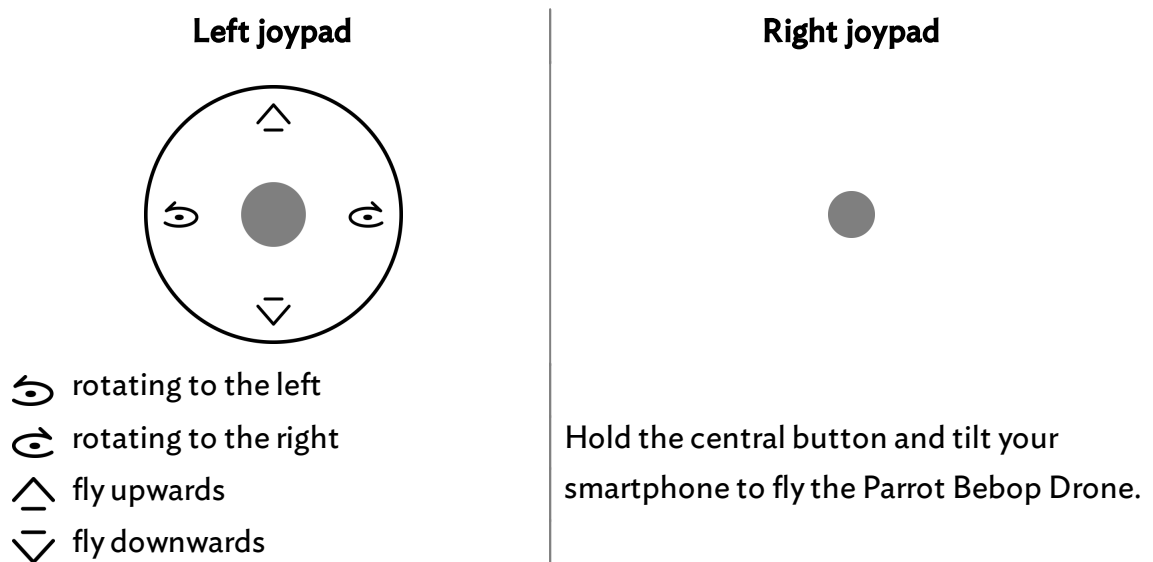

## Ace

### Left joypad

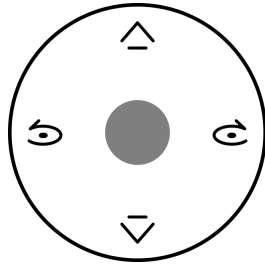

- rotating to the left
- rotating to the right
- fly upwards
- fly downwards

### Right joypad

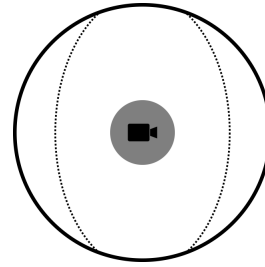

Slide to orientate the camera regardless of the Parrot Bebop Drone's position.

Hold the central button and tilt your smartphone to fly the Parrot Bebop Drone

## Joypad

### Left joypad

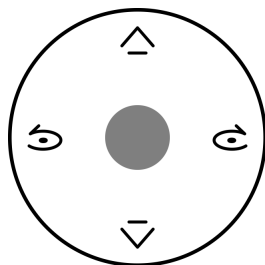

- rotating to the left
- rotating to the right
- fly upwards
- fly downwards

### Right joypad

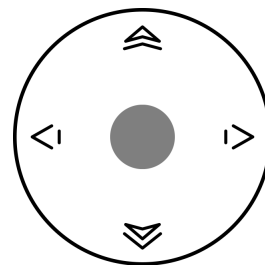

- fly forwards
- fly backwards
- fly right
- fly left

## Network

Product name

Select the **Network settings** screen.

The network name of your Parrot Bebop Drone appears in your smartphone peripheral

devices list and in the FreeFlight 3 application settings menu.

To change the network name of your Parrot Bebop Drone:

1. Change the Parrot Bebop Drone name in the **Product name** field.
2. Reboot the Parrot Bebop Drone.

Note: The network name of the Parrot Bebop Drone can only contain letters, numerals and underscores (" \_"). It must not exceed 32 characters in length.

## Wi-Fi

Select the **Network settings** screen.

Note: Before flying the Parrot Bebop Drone, please ensure that you comply with the Wi-Fi frequencies restrictions of your place of flight. Certain frequencies may be restricted or forbidden. Selecting the country and activating the outdoor option enable FreeFlight 3 to adapt the available channels according to the legislation of the selected country. For example, in certain countries using the 5 GHz Wi-Fi band may be prohibited in outdoor mode.

You can connect the Parrot Bebop Drone to the 2.4GHz or 5GHz Wi-Fi bands.

- The 2.4 GHz Wi-Fi band enables you to fly the Parrot Bebop Drone from a greater distance. It is generally more congested than the 5 GHz Wi-Fi band in urban areas.
- The 5 GHz Wi-Fi band enables you to obtain a better connection between the Parrot Bebop Drone and your smartphone. Check your smartphone user guide (or the technical specifications) to see whether it supports connection to the 5 GHz Wi-Fi band. If it does not, use the 2.4 GHz Wi-Fi band only.

Consult the diagram at the bottom of the screen to know the state of the Wi-Fi channels.

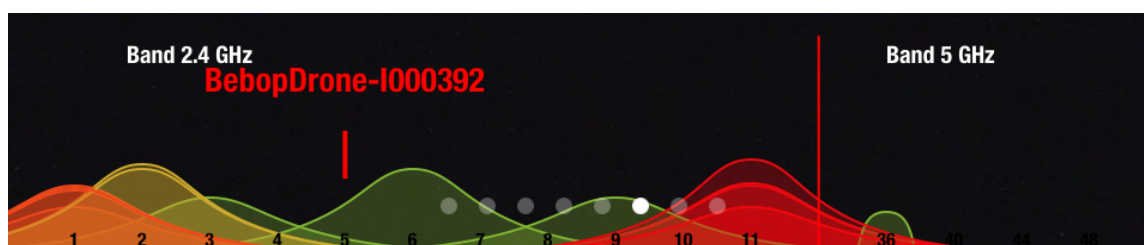

Red curves represent congested channels. Green curves represent less congested channels. The channel without curves are free.



To switch the Wi-Fi band (2.4 GHz or 5 GHz) manually without using the application, hold down the on/off button for 5 seconds .  
> The led turns orange, then green. The Parrot Bebop Drone has switched its Wi-Fi band.

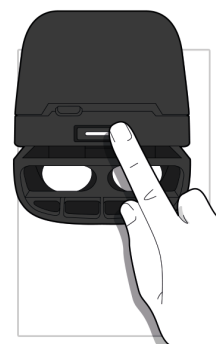

In automatic mode, FreeFlight 3 automatically selects a channel according to the country, the mode (outdoor or indoor), the Wi-Fi band selected and the congestion of the channels. If you encounter a problem with the quality level of the Wi-Fi connection:

1. Select **Manual mode**.
2. Select a non-overloaded channel using the information displayed on the diagram. Give preference to channel without curves or with green curves.

## Motor information

Select the **Motor information** screen to display:

- the motor state;
- the software version;
- the last flight date;
- the total flight time;
- the last error date.

## Version

Select the **Informations** screen to display:

- the FreeFlight 3 version;
- the Parrot Bebop Drone firmware version;
- the Parrot Bebop Drone hardware version;
- the GPS hardware version.

# Drone Academy

Note: An internet connection is necessary to use the Drone Academy.

To launch the Drone Academy:

1. Launch the FreeFlight 3 application.
2. Press **Drone Academy**.

Note: A profile is necessary to access the Drone Academy.

To create a profile:

1. Press **Sign up now**.
  2. Type a user name, a password and an e-mail address.
  3. Press **Register your profile**.
- > The Drone Academy main screen appears:

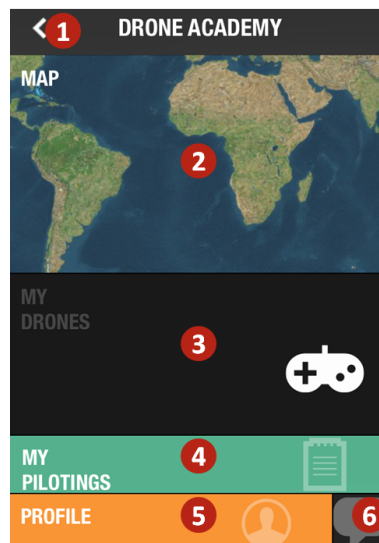

#	Description
---	-------------

1	Accessing the FreeFlight 3 application home screen
---	--

2	Visualizing the map of the flights
---	------------------------------------

3	Accessing your list of drones
---	-------------------------------

4	Accessing your list of flights
---	--------------------------------

---

5 Modifying and disconnecting your profile

---

6 Sending a Drone Academy invitation

---



To modify or delete your profile:

1. Press the **Profile** tab.
2. Press .
3. Press **Logout** or **Edit**.
4. If you edit your profile, slide the screens towards left to complete your profile.

To register a Parrot Bebop Drone, press **My drones**.

Note: The first time you connect the Parrot Bebop Drone to your smartphone, a pop-up ask you to register your Parrot Bebop Drone in the Drone Academy.

To consult the shared flights:

1. Press **Map**.
2. Press  to search flights amongst:
  - your flights or other user's flights;
  - the type of media.Press  to search flights by user or place.

To consult and share your flights:

1. Press **My pilotings**.
  - >The list of your flights appears. You can sort them by date, rank or type.
2. Press the flight you wish to share.
3. Press **Public** to share the flight. You can also:
  - press the stars to rate the flight;
  - press the tabs at the bottom of the screen to consult the flight information.

# Updating

1. Launch the FreeFlight 3 application.
2. Press **Check for updates** to check if any updates are available for the Parrot Bebop Drone.

There are 2 ways to update the Parrot Bebop Drone:

- via the FreeFlight 3 application (recommended)
- via USB, by downloading the update file from our website. A computer is necessary for this method.

Note: Ensure that the battery of the Parrot Bebop Drone is in place and fully charged before updating via USB.

For further information, see the [Parrot Bebop Drone update procedures](#).

# Troubleshooting

## Led behavior

Behavior	Signification
Green	Normal state
Blinking green	The Parrot Bebop Drone is booting up.
Orange	A motor error is detected. To locate the defective motor: <ol style="list-style-type: none"><li>1. In FreeFlight 3, press <b>Start</b>.</li><li>2. Press  &gt; <b>Motor information</b>. &gt;The screen indicates the defective motor.</li><li>3. Ensure the propeller is not blocked or damaged.</li></ol>
Blinking green	The Parrot Bebop Drone is defective and cannot fly correctly anymore.

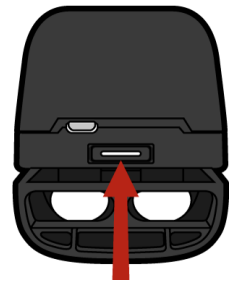

## Spare parts

You can buy spare parts of the Parrot Bebop Drone on our [online store](#).

For further information about replacing spare parts, see the video tutorials on our [support page](#).

# General information

The Parrot Bebop Drone is a model aircraft designed only for entertainment, and competitions between model aircraft (\*). The pilot must operate his/her Parrot Bebop Drone in his/her line-of-sight at all times in order to avoid any obstacles, and must take care only to use it in suitable locations chosen to ensure that people, animals and property remain safe at all times.

(\*) Before flying your Parrot Bebop Drone, check your local civil aerial regulation and read the guidelines on [www.parrot.com](http://www.parrot.com).

## Safety precautions and maintenance

The Parrot Bebop Drone is not suitable for use by children under 14 years of age.

Fly responsibly. Do not fly your Parrot Bebop Drone over any populous area, such as beaches, others people's backyards, heavily populated parks, or sports ovals where a game is in progress, over gathering of animals. Do not fly near an airfield. Do not fly for money. If you want to fly your Parrot Bebop Drone in any populous area or near an air field, do contact your local aerial authority to get the appropriate authorization.

To fly the Parrot Bebop Drone indoors install the hull in order to protect the Parrot Bebop Drone in case of contact with any object. When rotating, the propellers of the Parrot Bebop Drone could cause injury to people, animals and property.

**WARNING :** Do not touch the Parrot Bebop Drone when propellers are rotating and wait until the propellers have completely stopped before handling the Parrot Bebop Drone.

Do not use spare parts and accessories other than those specified by Parrot.

The Parrot Bebop Drone may be irreversibly damaged if you allow sand or dust to penetrate it. Keep the Parrot Bebop Drone away from high voltage power lines, trees, buildings and any other potentially dangerous or hazardous areas.

Do not use the Parrot Bebop Drone in wet conditions. Do not land the Parrot Bebop Drone on water or on a wet surface. This could result in irreversible damages.

Avoid subjecting the Parrot Bebop Drone to aggressive altitude changes.

Do not leave the Parrot Bebop Drone in direct sunlight for long periods.

Small parts may be swallowed. All materials for fastening or packing purposes are not part of the product and should be discarded for children's safety.

## Wi-Fi

Before flying the Parrot Bebop Drone, please ensure that you comply with the Wi-Fi frequencies restrictions of your place of flight. Certain frequencies may be restricted or forbidden. For example, in certain countries using the 5 GHz Wi-Fi band may be prohibited in outdoor mode.

## Warning on invasion of privacy

Recording and circulating an image of an individual may constitute an infringement of their image and privacy for which you could be liable. Ask for authorisation before filming individuals, particularly if you want to keep your recordings and/or circulate images on the Internet or any other medium. Do not circulate a degrading image or one which could undermine the reputation or dignity of an individual. The use of the Parrot Bebop Drone for surveillance or espionage is strictly forbidden and could result in your prosecution under the law. Check that your use of the cameras on board the Parrot Bebop Drone complies with the legal provisions on the protection of privacy.

## Battery

Read the entire instruction sheet included with this battery. Failure to follow all instructions could cause permanent damage to the battery and its surroundings, and cause bodily harm. Never use anything except a LiPo approved charger. Always use a LiPo cell balancing charger or a LiPo cell balancer. Never charge through the discharge lead. Never trickle charge, or allow to discharge below 2.5V per cell. Never allow the battery temperature to exceed 140°F (60°C). Never disassemble or modify pack wiring in any way or puncture cells. Never place on combustible materials or leave unattended during charge. Always charge in a fireproof location. Always set charger's output volts to match battery volts. Always keep out of reach of children. Improper battery use may result in a fire, explosion or other hazard.

The battery terminals should not be allowed to short-circuit. The product should be connected only to class II appliances which display the symbol.

## Warranty

Without prejudice to any applicable statutory warranty, Parrot warrants that the Parrot Bebop Drone will be free from defects in material and workmanship for a period of 12-months from the initial date of purchase (excluding consumables which are warranted during 6 months from the initial date of purchase) upon presentation of proof of purchase to the retailer or to Parrot (including the date and place of purchase, product

serial number). Return to retailer is not applicable in the USA - return shall be made to Parrot. During the contractual warranty period, any defective product should be returned in its original packaging to the retailer's or Parrot's after-sales service. After inspection of the product, Parrot will, at its sole discretion, either repair or replace the defective part or product, excluding any other indemnification of any nature. Parrot's warranty does not cover: defects due to damage caused by an accidental collision or fall; defects due to abnormal use of the product or if spare parts have been installed without following the recommendations and instructions provided by Parrot in this guide or on [www.parrot.com](http://www.parrot.com) or if the Parrot Bebop Drone has been customised by the end-user; defects caused by repairs carried out by the end-user or an unauthorised third party, except spare parts provided by PARROT; defects due to the use of spare parts not provided by PARROT in the original packaging, the use of spare parts not approved by Parrot, in particular, the use of batteries not approved by Parrot; defects caused by any reason other than a defect in material or workmanship the gradual power loss of the Parrot rechargeable battery (086x) over time, which does not constitute as a defect in material or workmanship, If upon technical tests being carried out any product is found non defective we reserve the right to return such product to the sender at the sender's cost and to levy a charge to cover Parrot's technical test fees. Upon expiration of the 12-month warranty period or if the defect is not covered by the warranty, any defective product can be returned to Parrot's after-sales service in order to be repaired or for a defective part to be replaced at the sender's costs. Repair will be carried out only after acceptance of the corresponding quotation. Except in relation to consumables, spare parts are subject to a 12 month warranty and are subject to the same terms and conditions as those described above. The warranty does not cover: damage to non Parrot products, including devices used to operate the Parrot Bebop Drone.

## Modifications

The explanations and specifications in this guide are given for information purposes only and may be modified without prior notice. They are deemed to be correct at time of going to press. The utmost care has been taken when writing this guide, as part of the aim to provide you with accurate information. However, Parrot shall not be held responsible for any consequences arising from any errors or omissions in the guide, nor for any damage or accidental loss of data resulting directly or indirectly from the use of the information herein. Parrot reserves the right to amend or improve the product design or user guide without any restrictions and without any obligation to notify users. As part of our ongoing concern to upgrade and improve our products, the product that you have purchased may differ slightly from the model described in this guide. If so, a



later version of this guide might be available in electronic format at Parrot's website at [www.parrot.com](http://www.parrot.com).

## Disposal of this product at the end of its life

At the end of this product's life, please do not dispose of this product in your general household waste. Instead, in order to prevent possible harm to the environment or human health from uncontrolled waste disposal, please dispose of this product separately in accordance with your local laws and regulation. For more information on the separate collection systems for waste electrical and electronic equipment that are available for consumers, near your home, free of charge, please contact your local municipality authority. You can also contact the retailer from which you purchased your Parrot Bebop Drone – he might have put in place recycling services or he may be part of a specific recycling scheme.

## Declaration of conformity

Parrot SA, 174 quai de Jemmapes, 75010 Paris, France, declare under their sole responsibility that the product described in this user guide complies with technical standards EN 301489-17, EN300328, EN71-1, EN71-2, EN71-3, EN62115 following the provision of the Radio Equipment, Telecommunication Equipment directive (1999/5/EC R&TTE), and of the General Safety directive (2001/95/EC).

<http://www.parrot.com/ce/?bebop-drone>

## Registered trademarks

Parrot, Parrot Bebop Drone are trademarks or registered trademarks of Parrot SA.

App Store is a trademark of Apple Inc.

Google Play is a trademark of Google Inc. Wi-Fi® is a registered trademark of Wi-Fi Alliance®.

All other trademarks mentioned in this guide are protected and are the property of their respective owners.