

SAMSUNG

USER MANUAL

SM-E236B/DS
SM-M236B/DS
SM-M336B/DS
SM-M336BU/DS

Table of Contents

Getting started

- 4 Device layout and functions
- 8 Charging the battery
- 11 SIM or USIM card (nano-SIM card)
- 12 Memory card (microSD card)
- 15 Turning the device on and off
- 16 Initial setup
- 16 Samsung account
- 17 Transferring data from your previous device (Smart Switch)
- 19 Understanding the screen
- 27 Notification panel
- 29 Screen capture and screen record
- 30 Entering text

Apps and features

- 33 Installing or uninstalling apps
- 34 Phone
- 37 Contacts
- 39 Messages
- 40 Internet
- 41 Camera
- 54 Gallery
- 58 AR Zone
- 64 Bixby Vision (SM-M336B/DS, SM-M336BU/DS)

- 65 Multi window
- 68 Samsung Pay
- 70 Samsung Health
- 71 Samsung Notes
- 72 Samsung Members
- 72 Samsung Kids
- 73 Samsung Global Goals
- 73 Samsung TV Plus
- 73 Galaxy Shop
- 73 Galaxy Wearable (SM-M336B/DS, SM-M336BU/DS)
- 74 Calendar
- 75 Reminder
- 76 Radio
- 76 Voice Recorder
- 77 My Files
- 77 Clock
- 77 Calculator
- 78 Game Launcher
- 79 Game Booster
- 80 SmartThings
- 81 Sharing content
- 82 Music Share
- 83 Smart View
- 84 Link to Windows (SM-M336B/DS, SM-M336BU/DS)
- 85 Google apps

Settings

- 86 Introduction
- 86 Samsung account
- 86 Connections
 - 88 Wi-Fi
 - 89 Bluetooth
 - 90 NFC and contactless payments
 - 92 Data saver
 - 92 Mobile data only apps
 - 92 Mobile Hotspot
 - 93 More connection settings
- 94 Sounds and vibration
 - 95 Sound quality and effects
 - 95 Separate app sound
- 96 Notifications
- 96 Display
 - 97 Motion smoothness
- 97 Wallpaper and style
- 97 Themes
- 98 Home screen
- 98 Lock screen
 - 99 Smart Lock
- 99 Biometrics and security
 - 100 Face recognition
 - 102 Fingerprint recognition
 - 104 Samsung Pass
 - 106 Secure Folder
 - 109 Secure Wi-Fi
- 110 Privacy
- 110 Location
- 111 Safety and emergency
- 111 Accounts and backup
 - 112 Samsung Cloud
- 112 Google

- 113 Advanced features
 - 114 Motions and gestures
 - 115 Video call effects
 - 115 Dual Messenger
- 116 Digital Wellbeing and parental controls
- 117 Battery and device care
 - 117 Optimising your device
 - 117 Battery
 - 118 Storage
 - 118 Memory
 - 118 Device protection
 - 118 Ultra data saving
 - 119 Software update
 - 119 Diagnostics
- 119 Apps
- 119 General management
- 121 Accessibility
- 121 Software update
- 122 Remote support
- 122 About phone

Usage notices

- 123 Precautions for using the device
- 125 Notes on package contents and accessories
- 126 Device overheating situations and solutions

Appendix

- 129 Troubleshooting
- 134 Removing the battery

Getting started

Device layout and functions

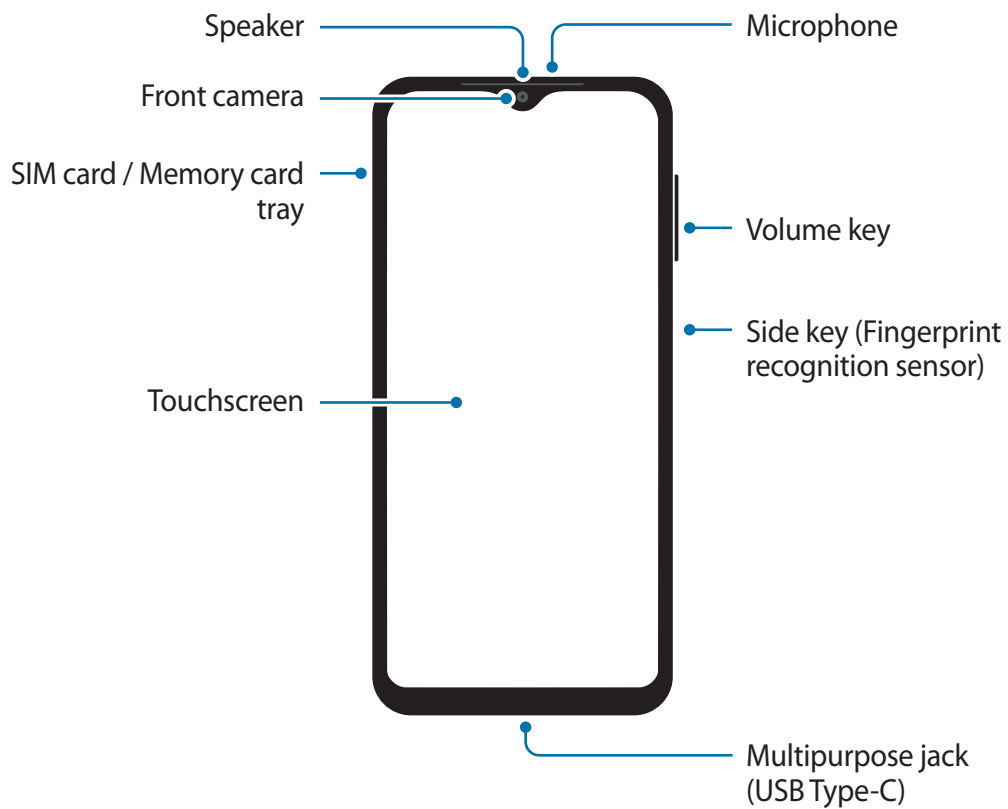

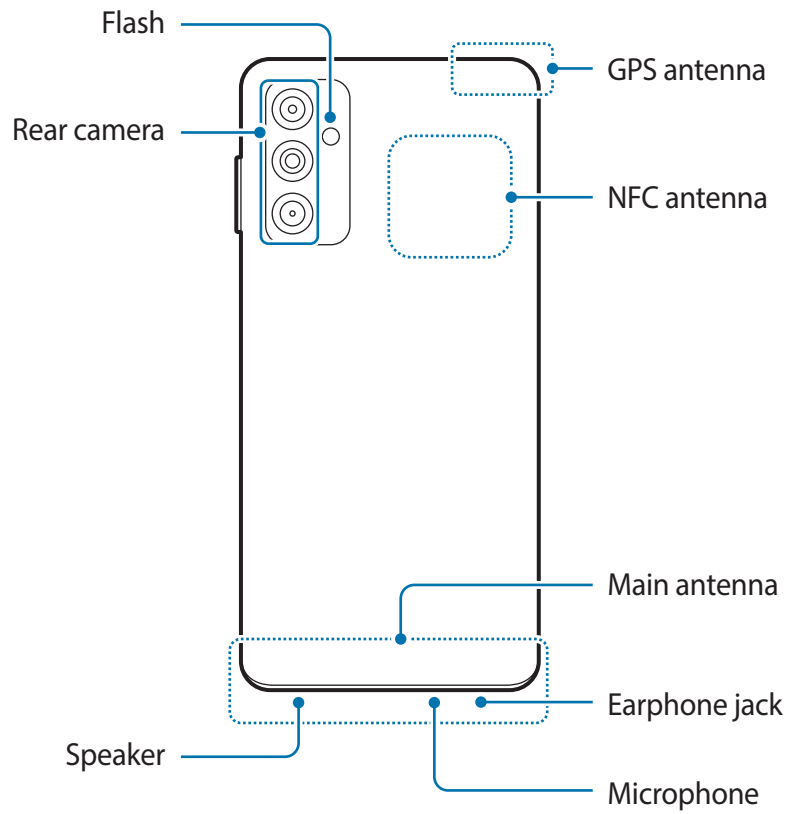

► SM-E236B/DS, SM-M236B/DS:

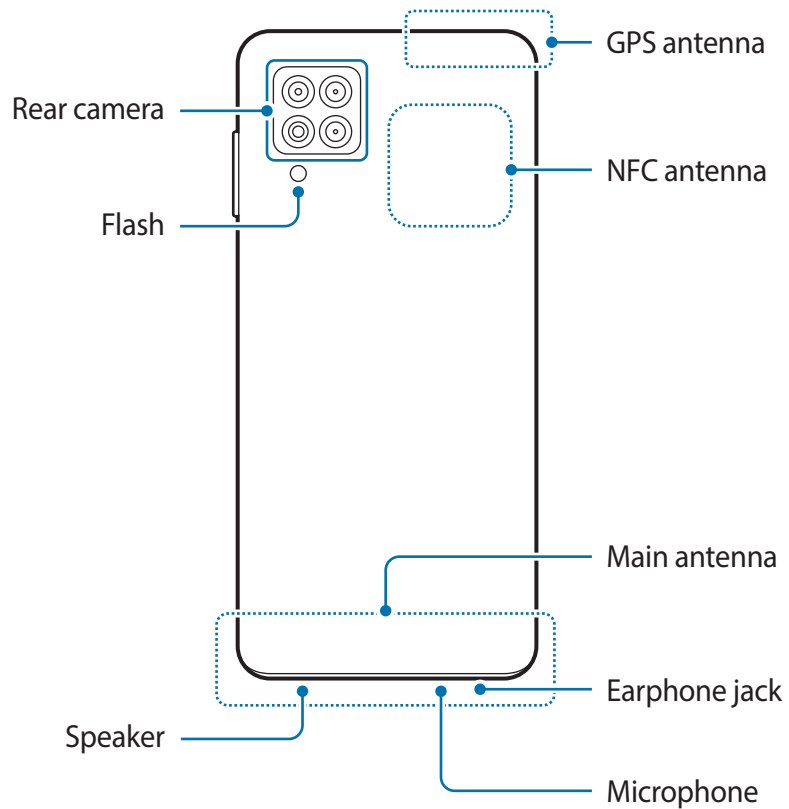

► SM-M336B/DS, SM-M336BU/DS:



-  When using the speakers, such as when playing media files or using speakerphone, do not place the device close to your ears.
- Be careful not to expose the camera lens to a strong light source, such as direct sunlight. If the camera lens is exposed to a strong light source, such as direct sunlight, the camera image sensor may be damaged. A damaged image sensor is irreparable and will cause dots or spots in pictures.
- If you use the device with its glass or acrylic body broken, there may be a risk of injury. Use the device only after it has been repaired at a Samsung Service Centre.
- If dust or foreign materials enter the microphone, speaker, or receiver, the device's sound may become quiet or certain features may not work. If you attempt to remove the dust or foreign materials with a sharp object, the device may be damaged and its appearance may be affected.
-  Connectivity problems and battery drain may occur in the following situations:
 - If you attach metallic stickers on the antenna area of the device
 - If you attach a device cover made with metallic material to the device
 - If you cover the device's antenna area with your hands or other objects while using certain features, such as calls or the mobile data connection
- Do not allow water to contact the touchscreen. The touchscreen may malfunction in humid conditions or when exposed to water.

Hard keys

Key	Function
Side key	<ul style="list-style-type: none"> • Press and hold to turn the device on or off. • Press to turn on or lock the screen. • Press twice to launch the app or feature you set.
Side key + Volume Down key	<ul style="list-style-type: none"> • Press simultaneously to capture a screenshot. • Press and hold simultaneously to turn off the device.

Setting the Side key

Select an app or feature to launch by pressing the Side key twice.

Launch the **Settings** app, tap **Advanced features** → **Side key**, and then select an option you want.

Soft buttons

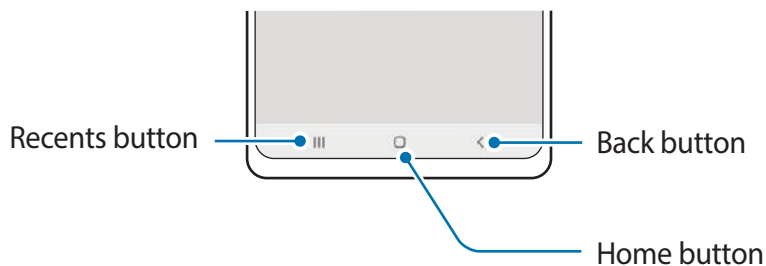

When you turn on the screen, the soft buttons will appear at the bottom of the screen. Refer to [Navigation bar \(soft buttons\)](#) for more information.

Charging the battery

Charge the battery before using it for the first time or when it has been unused for extended periods.

Wired charging

Connect the USB cable to the USB power adaptor and plug the cable into the device's multipurpose jack to charge the battery. After fully charging, disconnect the charger from the device.

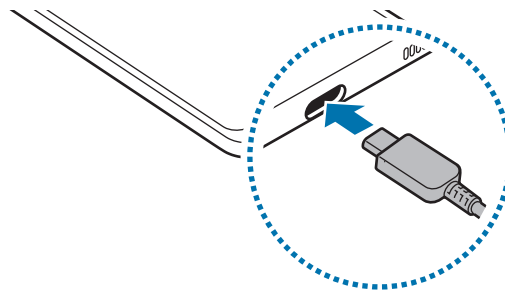

Quick charging

Launch the **Settings** app, tap **Battery and device care** → **Battery** → **More battery settings**, and then activate the feature you want.

- **Fast charging:** To use the fast charging feature, use a battery charger that supports Adaptive fast charging.

 You can charge the battery more quickly while the device or its screen is turned off.

Charging other devices

Use the USB cable to charge another mobile device with your device's battery.

Connect your device and the other device using your device's USB cable. A USB connector may be needed depending on the other device.

When charging starts, the battery charging icon will appear on the other device's screen.



 The app selection pop-up window that appears on your device is for data transfer. Do not select an app from the pop-up window.

Reducing the battery consumption

Your device provides various options that help you conserve battery power.

- Optimise the device using the device care feature.
- When you are not using the device, turn off the screen by pressing the Side key.
- Activate power saving mode.
- Close unnecessary apps.
- Deactivate the Bluetooth feature when not in use.
- Deactivate auto-syncing of apps that need to be synced.
- Decrease the backlight time.
- Decrease the screen brightness.

Battery charging tips and precautions

-  Use only Samsung-approved battery, charger, and cable specifically designed for your device. Incompatible battery, charger, and cable can cause serious injuries or damage to your device.
- 
 - Connecting the charger improperly may cause serious damage to the device. Any damage caused by misuse is not covered by the warranty.
 - Use only USB Type-C cable supplied with the device. The device may be damaged if you use Micro USB cable.
 - If you charge the device while the multipurpose jack is wet, the device may be damaged. Thoroughly dry the multipurpose jack before charging the device.



- To save energy, unplug the charger when not in use. The charger does not have a power switch, so you must unplug the charger from the electric socket when not in use to avoid wasting power. The charger should remain close to the electric socket and easily accessible while charging.
- When using a charger, it is recommended to use an approved wired or wireless charger that guarantees the charging performance.
- If the battery is completely discharged, the device cannot be turned on immediately when the charger is connected. Allow a depleted battery to charge for a few minutes before turning on the device.
- If you use multiple apps at once, network apps, or apps that need a connection to another device, the battery will drain quickly. To avoid losing power during a data transfer, always use these apps after fully charging the battery.
- Using a power source other than the charger, such as a computer, may result in a slower charging speed due to a lower electric current.
- The device can be used while it is charging, but it may take longer to fully charge the battery.
- If the device receives an unstable power supply while charging, the touchscreen may not function. If this happens, unplug the charger from the device.
- While charging, the device and the charger may heat up. This is normal and should not affect the device's lifespan or performance. If the battery gets hotter than usual, the charger may stop charging.
- If the device is not charging properly, take the device and the charger to a Samsung Service Centre.

SIM or USIM card (nano-SIM card)

Insert the SIM or USIM card provided by the mobile telephone service provider.

You can insert two SIM or USIM cards so you can have two phone numbers or service providers for a single device. In some areas, data transfer speeds may be slower if two SIM cards are inserted in the device than when one SIM card is inserted.

 Some services that require a network connection may not be available depending on the service provider.

Installing the SIM or USIM card

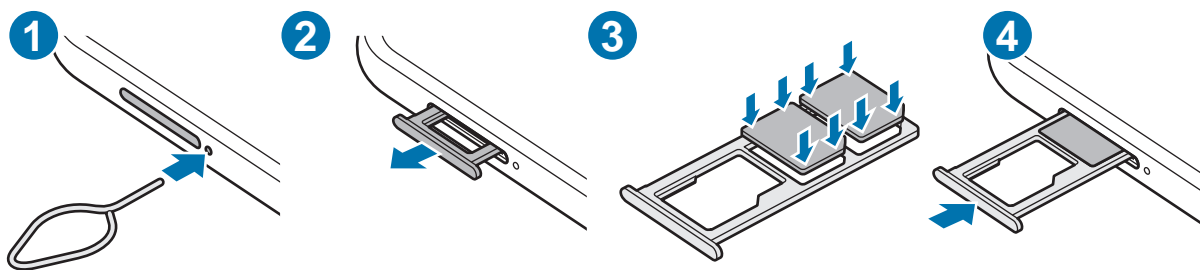

- 1 Insert the ejection pin into the hole next to the tray to loosen the tray.
- 2 Pull out the tray gently from the tray slot.
- 3 Place the SIM or USIM card on the tray with the gold-coloured contacts facing downwards and gently press the SIM or USIM card into the tray to secure it.
- 4 Insert the tray back into the tray slot.

-  • Use only a nano-SIM card.
- Use caution not to lose or let others use the SIM or USIM card. Samsung is not responsible for any damages or inconveniences caused by lost or stolen cards.
- Ensure that the ejection pin is perpendicular to the hole. Otherwise, the device may be damaged.
- If the card is not fixed firmly into the tray, the SIM card may leave or fall out of the tray.
- If you insert the tray into your device while the tray is wet, your device may be damaged. Always make sure the tray is dry.
- Fully insert the tray into the tray slot to prevent liquid from entering your device.

SIM card manager

Launch the **Settings** app and tap **Connections** → **SIM card manager**.

- **SIM cards:** Activate the SIM card to use and customise the SIM card settings.
- **Preferred SIM card:** Select to use specific SIM cards for some features, such as voice calls, when two cards are activated.
- **Auto data switching:** Set the device to use another SIM card for data services if the preferred SIM card cannot connect to the network.
- **More SIM card settings:** Customise the call settings.

Memory card (microSD card)

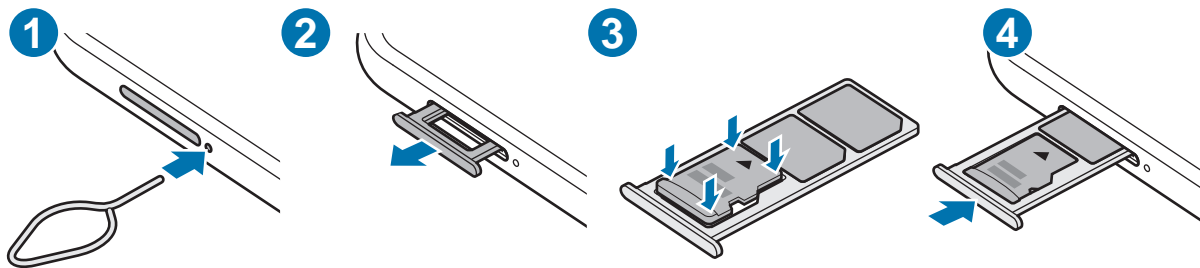

Installing a memory card

Your device's memory card capacity may vary from other models and some memory cards may not be compatible with your device depending on the memory card manufacturer and type. To view your device's maximum memory card capacity, refer to the Samsung website.



- 1 Insert the ejection pin into the hole next to the tray to loosen the tray.
- 2 Pull out the tray gently from the tray slot.
- 3 Place a memory card on the tray with the gold-coloured contacts facing downwards and gently press the memory card into the tray to secure it.

4 Insert the tray back into the tray slot.

-  Some memory cards may not be fully compatible with the device. Using an incompatible card may damage the device or the memory card, or corrupt the data stored in it.
- Use caution to insert the memory card right-side up.
- Ensure that the ejection pin is perpendicular to the hole. Otherwise, the device may be damaged.
- When you remove the tray from the device, the mobile data connection will be disabled.
- If the card is not fixed firmly into the tray, the memory card may leave or fall out of the tray.
- If you insert the tray into your device while the tray is wet, your device may be damaged. Always make sure the tray is dry.
- Fully insert the tray into the tray slot to prevent liquid from entering your device.
-  The device supports the FAT and the exFAT file systems for memory cards. When inserting a card formatted in a different file system, the device will ask to reformat the card or will not recognise the card. To use the memory card, you must format it. If your device cannot format or recognise the memory card, contact the memory card manufacturer or a Samsung Service Centre.
- Frequent writing and erasing of data shortens the lifespan of memory cards.
- When inserting a memory card into the device, the memory card's file directory appears in the **My Files** → **SD card** folder.

Removing the memory card

Before removing the memory card, first unmount it for safe removal.

- 1 Launch the **Settings** app and tap **Battery and device care** → **Storage**.
- 2 Swipe to the left to view the **SD card** page.
- 3 Tap  → **Unmount**.

 Do not remove external storage, such as a memory card or USB storage, while the device is transferring or accessing information, or right after transferring data. Doing so can cause data to be corrupted or lost or cause damage to the external storage or device. Samsung is not responsible for losses, including loss of data, resulting from the misuse of external storage devices.

Formatting the memory card

A memory card formatted on a computer may not be compatible with the device. Format the memory card on the device.

- 1 Launch the **Settings** app and tap **Battery and device care** → **Storage**.
- 2 Swipe to the left to view the **SD card** page.
- 3 Tap  → **Format**.

 Before formatting the memory card, remember to make backup copies of all important data stored in the memory card. The manufacturer's warranty does not cover loss of data resulting from user actions.

Turning the device on and off

- Follow all posted warnings and directions from authorised personnel in areas where the use of wireless devices is restricted, such as aeroplanes and hospitals.

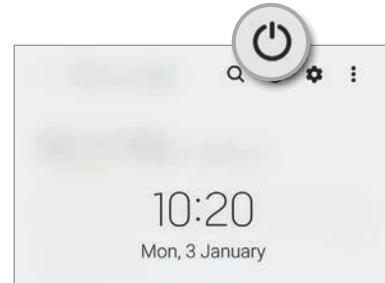
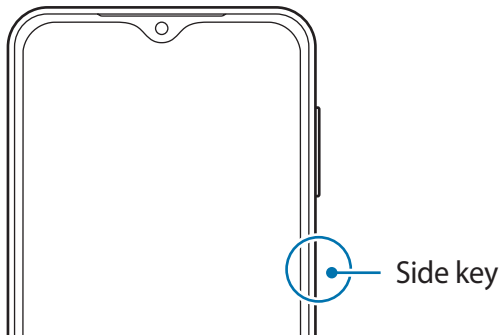

Turning the device on

Press and hold the Side key for a few seconds to turn on the device.

Turning the device off

- To turn off the device, press and hold the Side key. Alternatively, open the notification panel, swipe downwards, and then tap .
- Tap **Power off**.
To restart the device, tap **Restart**.

Forcing restart

If your device is frozen and unresponsive, press and hold the Side key and the Volume Down key simultaneously for more than 7 seconds to restart it.

Emergency mode

You can switch the device to emergency mode to reduce battery consumption. Some apps and functions will be restricted. In emergency mode, you can make an emergency call, send your current location information to others, sound an emergency alarm, and more.

To activate emergency mode, press and hold the Side key, and then tap **Emergency mode**. Alternatively, open the notification panel, swipe downwards, and then tap  → **Emergency mode**.

To deactivate emergency mode, tap  → **Turn off Emergency mode**.

- The usage time left shows the time remaining before the battery power runs out. Usage time left may vary depending on your device settings and operating conditions.

Initial setup

When you turn on your device for the first time or after performing a data reset, follow the on-screen instructions to set up your device.

-  If you do not connect to a Wi-Fi network, you may not be able to set up some device features during the initial setup.

Samsung account

Your Samsung account is an integrated account service that allows you to use a variety of Samsung services provided by mobile devices, TVs, and the Samsung website.

To check the list of services that can be used with your Samsung account, visit account.samsung.com.

- 1 Launch the **Settings** app and tap **Samsung account**.
Alternatively, launch the **Settings** app and tap **Accounts and backup** → **Manage accounts** → **Add account** → **Samsung account**.
- 2 If you already have a Samsung account, sign in to your Samsung account.
 - If you want to sign in using your Google account, tap **Sign in with Google**.
 - If you do not have a Samsung account, tap **Create account**.

Finding your ID and resetting your password

If you forget your Samsung account ID or password, tap **Find ID** or **Forgot password?** on the Samsung account sign-in screen. You can find your ID or reset your password after you enter the required information.

Signing out of your Samsung account

When you sign out of your Samsung account, your data, such as contacts or events, will also be removed from your device.

- 1 Launch the **Settings** app and tap **Accounts and backup** → **Manage accounts**.
- 2 Tap **Samsung account** → **My profile** and tap **Sign out** at the bottom of the screen.
- 3 Tap **Sign out**, enter your Samsung account password, and then tap **OK**.

Transferring data from your previous device (Smart Switch)



You can use Smart Switch to transfer data from your previous device to your new device. Launch the **Settings** app and tap **Accounts and backup** → **Bring data from old device**.



- This feature may not be supported on some devices or computers.
- Limitations apply. Visit www.samsung.com/smartswitch for details. Samsung takes copyright seriously. Only transfer content that you own or have the right to transfer.

Transferring data using a USB cable

You can connect your previous device to your device with the USB cable to easily and quickly transfer data.

- 1 Connect your device and the previous device using your device's USB cable.
A USB connector may be needed depending on the previous device.
 - 2 When the app selection pop-up window appears, tap **Smart Switch** → **Receive data**.
 - 3 In the previous device, tap **Allow**.
If you do not have the app, download it from **Galaxy Store** or **Play Store**.
Your device will recognise the previous device and a list of data you can transfer will appear.
 - 4 On your device, select an option you want, tap **Next**, and then follow the on-screen instructions to transfer data.
-  Do not disconnect the USB cable from the device when you are transferring files. Doing so may cause data loss or device damage.
-  Transferring data increases the battery power consumption of your device. Ensure that your device is sufficiently charged before transferring data. If the battery power is low, data transfer may be interrupted.

Transferring data wirelessly

Transfer data from your previous device to your device wirelessly via Wi-Fi Direct.

- 1 On the previous device, launch **Smart Switch**.
If you do not have the app, download it from **Galaxy Store** or **Play Store**.
- 2 On your device, launch the **Settings** app and tap **Accounts and backup** → **Bring data from old device**.

- 3 Place the devices near each other.
- 4 On the previous device, tap **Send data** → **Wireless**.
- 5 On your device, tap **Receive data**, select your previous device's operating system, and then tap **Wireless**.
- 6 On the previous device, tap **Allow**.
- 7 On your device, select an option you want, tap **Next**, and then follow the on-screen instructions to transfer data.

Backing up and restoring data using external storage

Transfer data using external storage, such as a microSD card.

- 1 Back up data from your previous device to external storage.
- 2 Insert or connect the external storage device to your device.
- 3 On your device, launch the **Settings** app and tap **Accounts and backup** → **External storage transfer**.
- 4 Select the backup date under **Restore from SD card**.
- 5 Select an option you want, tap **Next**, and then follow the on-screen instructions to transfer data from external storage.

Transferring backup data from a computer

Transfer data between your device and a computer. You must download the Smart Switch computer version app from www.samsung.com/smartswitch. Back up data from your previous device to a computer and import the data to your device.

- 1 On the computer, visit www.samsung.com/smartswitch to download Smart Switch.
- 2 On the computer, launch Smart Switch.
-  If your previous device is not a Samsung device, back up data to a computer using a program provided by the device's manufacturer. Then, skip to the fifth step.
- 3 Connect your previous device to the computer using the device's USB cable.
- 4 On the computer, follow the on-screen instructions to back up data from the device. Then, disconnect your previous device from the computer.
- 5 Connect your device to the computer using the USB cable.
- 6 On the computer, follow the on-screen instructions to transfer data to your device.

Understanding the screen

Controlling the touchscreen

Tapping

Tap the screen.

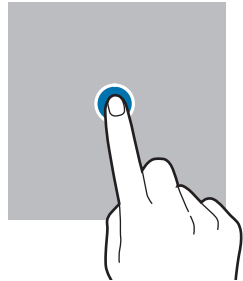

Tapping and holding

Tap and hold the screen for approximately 2 seconds.

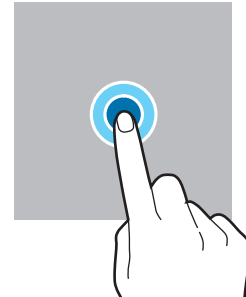

Dragging

Tap and hold an item and drag it to the target position.

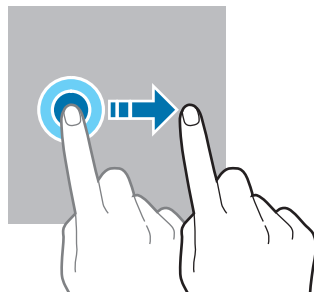

Double-tapping

Double-tap the screen.

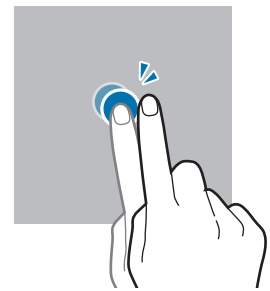

Swiping

Swipe upwards, downwards, to the left, or to the right.

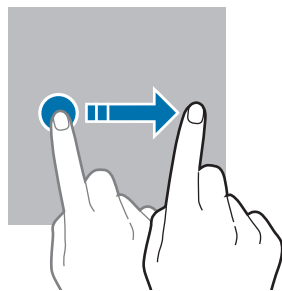

Spreading and pinching

Spread two fingers apart or pinch on the screen.

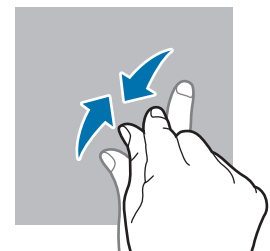
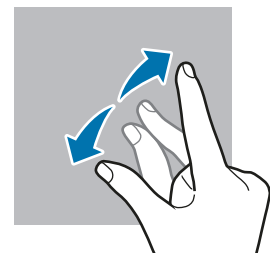

- ⚠ • Do not allow the touchscreen to come into contact with other electrical devices. Electrostatic discharges can cause the touchscreen to malfunction.
 - To avoid damaging the touchscreen, do not tap it with anything sharp or apply excessive pressure to it with your fingertips.
 - It is recommended not to use fixed graphics on part or all of the touchscreen for extended periods. Doing so may result in afterimages (screen burn-in) or ghosting.
- 📏 The device may not recognise touch inputs close to the edges of the screen, which are outside of the touch input area.

Navigation bar (soft buttons)

When you turn on the screen, the soft buttons will appear on the navigation bar at the bottom of the screen. The soft buttons are set to the Recents button, Home button, and Back button by default. The functions of the buttons can change according to the app currently being used or usage environment.

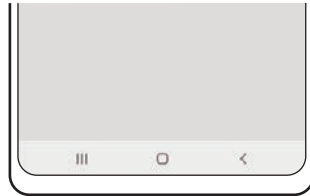

Button		Function
	Recents	<ul style="list-style-type: none"> • Tap to open the list of recent apps.
○	Home	<ul style="list-style-type: none"> • Tap to return to the Home screen. • Tap and hold to launch the Google Assistant app.
<	Back	<ul style="list-style-type: none"> • Tap to return to the previous screen.

Hiding the navigation bar

View files or use apps on a wider screen by hiding the navigation bar.

Launch the **Settings** app, tap **Display** → **Navigation bar**, and then tap **Swipe gestures** under **Navigation type**. The navigation bar will be hidden and the gesture hints will appear. Tap **More options** and select an option you want.



Swipe from bottom



Swipe from sides and bottom

If you want to hide the gesture hints at the bottom of the screen, tap the **Gesture hint** switch to deactivate it.

Home screen and Apps screen

The Home screen is the starting point for accessing all of the device's features. It displays widgets, shortcuts to apps, and more.

The Apps screen displays icons for all apps, including newly installed apps.

Switching between Home and Apps screens

On the Home screen, swipe upwards to open the Apps screen.

To return to the Home screen, swipe upwards or downwards on the Apps screen.

Alternatively, tap the Home button or the Back button.

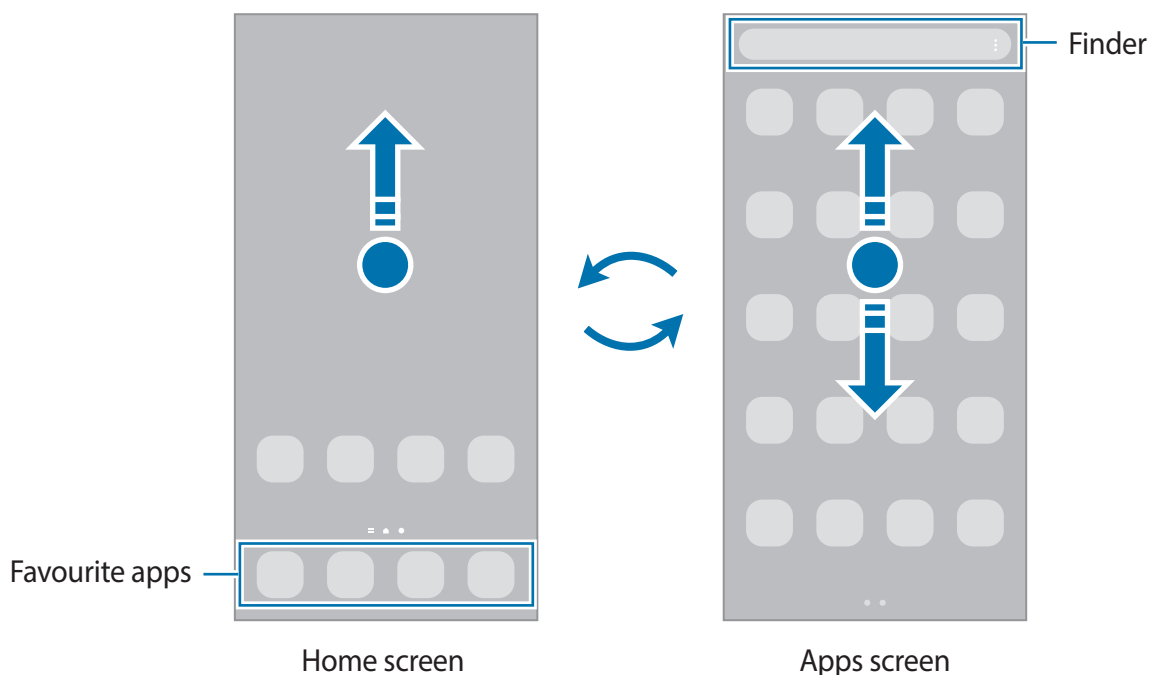



If you add the Apps button on the Home screen, you can open the Apps screen by tapping the button. On the Home screen, tap and hold an empty area, tap **Settings**, and then tap the **Show Apps screen button on Home screen** switch to activate it. The Apps button will be added at the bottom of the Home screen.



Editing the Home screen

On the Home screen, tap and hold an empty area, or pinch your fingers together to access the editing options. You can set the wallpaper, add widgets, and more. You can also add, delete, or rearrange Home screen panels.

- Adding panels: Swipe to the left, and then tap .
- Moving panels: Tap and hold a panel preview, and then drag it to a new location.
- Deleting panels: Tap  on the panel.

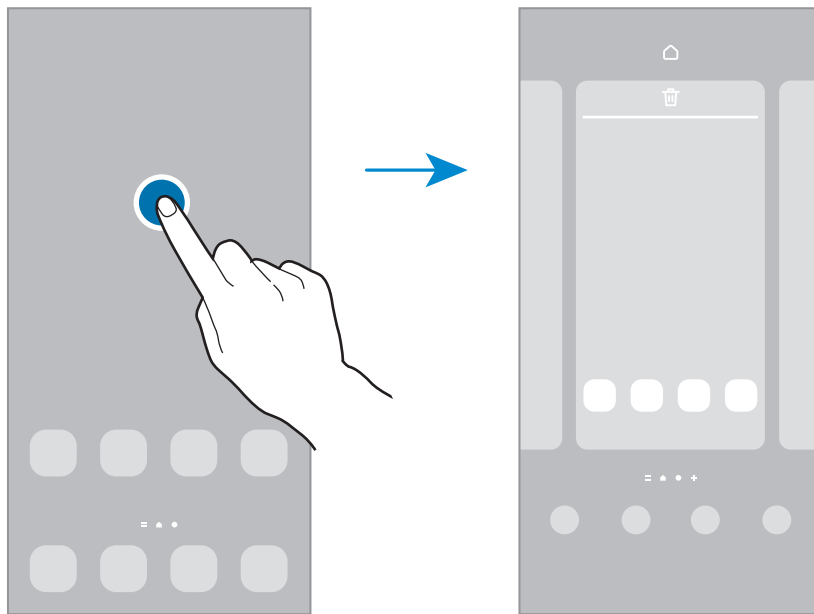

- **Wallpaper and style:** Change the wallpaper settings for the Home screen and the locked screen.
- **Themes:** Change the device's theme. Visual elements of interface, such as colours, icons, and wallpapers, will change depending on the selected theme.
- **Widgets:** Widgets are small apps that launch specific app functions to provide information and convenient access on your Home screen. Select a widget and tap **Add**. The widget will be added on the Home screen.
- **Settings:** Configure settings for the Home screen, such as the screen layout.

Displaying all apps on the Home screen

Without using a separate Apps screen, you can set the device to display all apps on the Home screen. On the Home screen, tap and hold an empty area, and then tap **Settings** → **Home screen layout** → **Home screen only** → **Apply**.

You can now access all your apps by swiping to the left on the Home screen.

Launching Finder

Search for content on the device quickly.

- 1 On the Apps screen, tap **Search**. Alternatively, open the notification panel, swipe downwards, and then tap **Q**.
- 2 Enter a keyword.
Apps and content on your device will be searched.
If you tap **Q** on the keyboard, you can search for more content.

Moving items

Tap and hold an item, and then drag it to a new location. To move the item to another panel, drag it to the side of the screen.

To add a shortcut to an app on the Home screen, tap and hold an item on the Apps screen, and then tap **Add to Home**. A shortcut to the app will be added on the Home screen.

You can also move frequently used apps to the shortcuts area at the bottom of the Home screen.

Creating folders

Create folders and gather similar apps to quickly access and launch apps.

On the Home screen or the Apps screen, tap and hold an app, and then drag it over another app.

A new folder containing the selected apps will be created. Tap **Folder name** and enter a folder name.

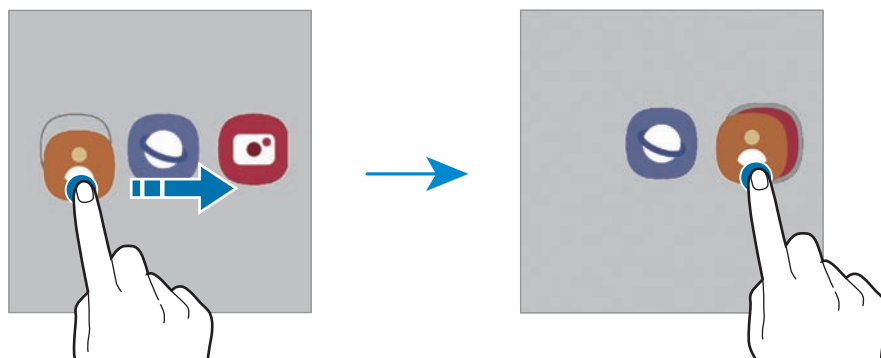

- **Adding more apps**

Tap **+** on the folder. Tick the apps to add and tap **Done**. You can also add an app by dragging it to the folder.

- **Moving apps from a folder**

Tap and hold an app to drag it to a new location.

- **Deleting a folder**

Tap and hold a folder, and then tap **Delete folder**. Only the folder will be deleted. The folder's apps will be relocated to the Apps screen.

Edge panel

You can quickly access your favourite apps and features from the Edge panels.

Drag the Edge panel handle towards the centre of the screen.

If the Edge panel handle is not visible, launch the **Settings** app, tap **Display**, and then tap the **Edge panels** switch to activate it.

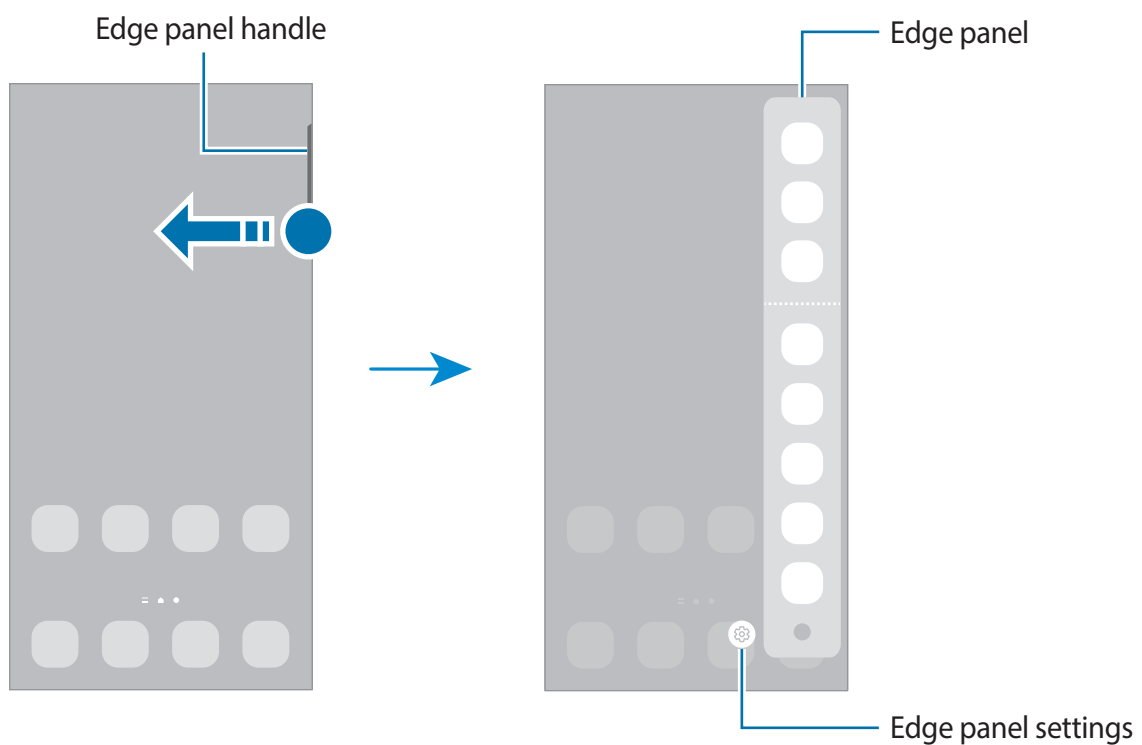

Lock screen

Pressing the Side key turns off the screen and locks it. Also, the screen turns off and automatically locks if the device is not used for a specified period.

To unlock the screen, swipe in any direction when the screen turns on.

If the screen is off, press the Side key to turn on the screen. Alternatively, double-tap the screen.

Changing the screen lock method



















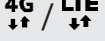



To change the screen lock method, launch the **Settings** app, tap **Lock screen** → **Screen lock type**, and then select a method.

When you set a pattern, PIN, password, or your biometric data for the screen lock method, you can protect your personal information by preventing others from accessing your device. After setting the screen lock method, the device will require an unlock code whenever unlocking it.

 You can set your device to perform a factory data reset if you enter the unlock code incorrectly several times in a row and reach the attempt limit. Launch the **Settings** app, tap **Lock screen** → **Secure lock settings**, unlock the screen using the preset screen lock method, and then tap the **Auto factory reset** switch to activate it.

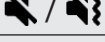
Indicator icons

Indicator icons appear on the status bar at the top of the screen. The icons listed in the table below are most common.

Icon	Meaning
	No signal
	Signal strength
	Roaming (outside of normal service area)
	GPRS network connected
	EDGE network connected
	UMTS network connected
	HSDPA network connected
	HSPA+ network connected
	LTE network connected
	5G network connected
	LTE network connected in LTE network that includes the 5G network
	Wi-Fi connected
	Bluetooth feature activated
	Location services being used
	Call in progress
	Missed call
	New text or multimedia message
	Alarm activated
	Mute mode / Vibration mode
	Flight mode activated
	Error occurred or caution required
	Battery charging / Battery power level



- The status bar may not appear at the top of the screen in some apps. To display the status bar, drag down from the top of the screen.
- Some indicator icons appear only when you open the notification panel.
- The indicator icons may appear differently depending on the service provider or model.

Notification panel

When you receive new notifications, indicator icons appear on the status bar. To see more information about the icons, open the notification panel and view the details.

To open the notification panel, drag the status bar downwards. To close the notification panel, swipe upwards on the screen.

You can use the following functions on the notification panel.

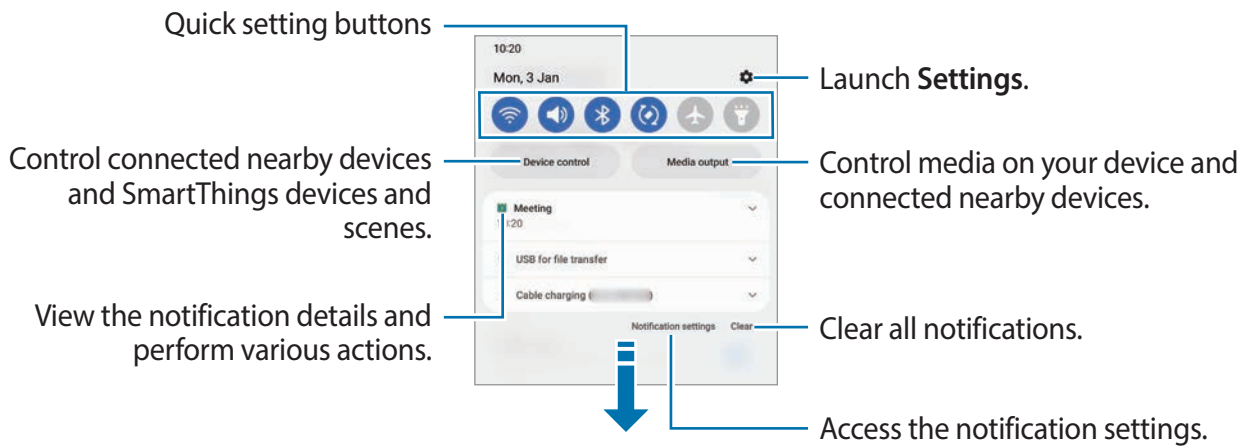

Using quick setting buttons

Tap quick setting buttons to activate certain features. Swipe downwards on the notification panel to view more buttons. To add more buttons, tap (+).

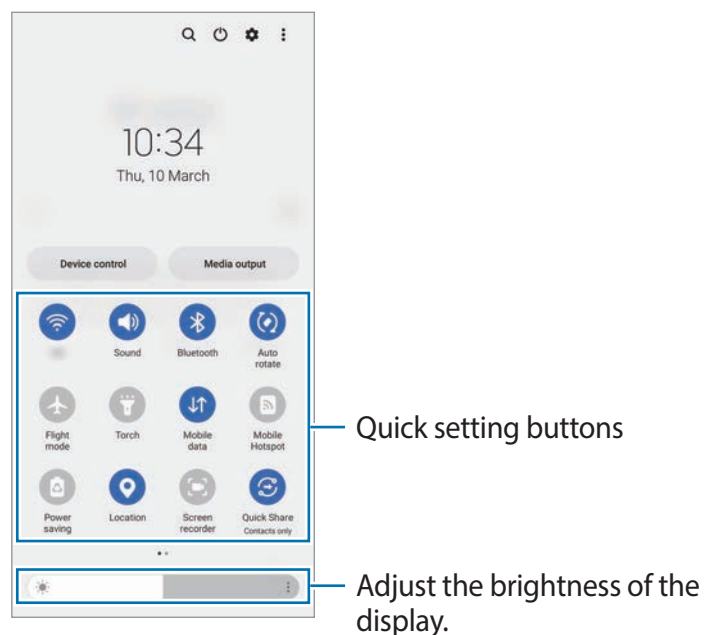

To change feature settings, tap the text under each button. To view more detailed settings, tap and hold a button.

To rearrange buttons, tap  → **Edit buttons**, tap and hold a button, and then drag it to another location.

Controlling media playback

Take control of music or video playback easily using the Media feature.

- 1 Open the notification panel and tap **Media output**.
- 2 Tap the icons on the controller to control the playback.

Controlling nearby devices

Launch quickly and take control of nearby connected devices and frequently used SmartThings devices and scenes on the notification panel.

- 1 Open the notification panel and tap **Device control**.
Nearby connected devices and SmartThings devices and scenes will appear.
- 2 Select a nearby device or a SmartThings device to control it, or select a scene to launch it.

Screen capture and screen record

Screen capture





Capture a screenshot while using the device.

Press the Side key and the Volume Down key simultaneously. You can view the captured screenshots in **Gallery**.

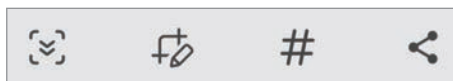
 It is not possible to capture a screenshot while using some apps and features.

After capturing a screenshot, use the following options on the toolbar at the bottom of the screen:







- : Capture the current content and the hidden content on an elongated page, such as a webpage. When you tap , the screen will automatically scroll down and more content will be captured.
- : Write or draw on the screenshot or crop a portion from the screenshot. You can view the cropped area in **Gallery**.
- : Add tags to the screenshot. To search for screenshots by tag, tap **Search** at the top of the Apps screen and tap **Screenshots** → **Q**. You can view the tags list and easily search for the screenshot you want. (SM-M336B/DS, SM-M336BU/DS)
- : Share the screenshot with others.

 If the options are not visible on the captured screen, launch the **Settings** app, tap **Advanced features** → **Screenshots and screen recorder**, and then tap the **Screenshot toolbar** switch to activate it.

Screen record

Record the screen while using your device.

- 1 Open the notification panel, swipe downwards, and then tap  (**Screen recorder**) to activate it.
- 2 Select a sound setting and tap **Start recording**.
After a countdown, recording will start.
 - To write or draw on the screen, tap .
 - To record the screen with a video overlay of yourself, tap .
- 3 When you are finished recording the video, tap .
You can view the video in **Gallery**.

 To change the screen recorder settings, launch the **Settings** app and tap **Advanced features** → **Screenshots and screen recorder**.

Entering text

Keyboard layout

A keyboard appears automatically when you enter text.

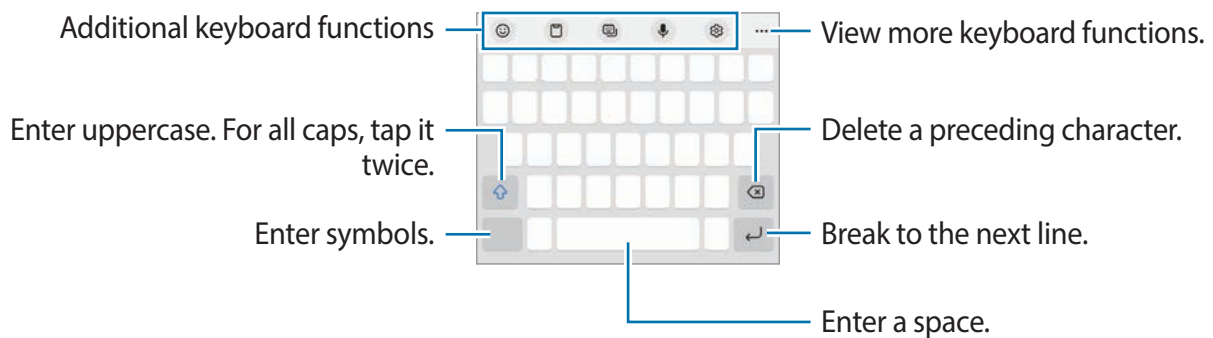

 Text entry is not supported in some languages. To enter text, you must change the input language to one of the supported languages.



Changing the input language

Tap  → **Languages and types** → **Manage input languages** and select the languages to use. When you select two or more languages, you can switch between the input languages by swiping to the left or right on the space key.





Changing the keyboard

On the navigation bar, tap  to change the keyboard.













To change the keyboard type, tap  → **Languages and types**, select a language, and then select the keyboard type you want.

-  • If the keyboard button () does not appear on the navigation bar, launch the **Settings** app, tap **General management** → **Keyboard list and default**, and then tap the **Keyboard button on navigation bar** switch to activate it.
- On a **3 x 4** keyboard, a key has three or four characters. To enter a character, tap the corresponding key repeatedly until the desired character appears.

Additional keyboard functions



- : Enter emojis, stickers, and more. You can also enter your emoji stickers that look like you. Refer to [Using your AR emoji stickers in chats](#) for more information.
- : Add an item from the clipboard.
- : Change the keyboard mode.
- : Enter text by voice.
- : Change the keyboard settings.

Tap  to use more keyboard functions.

- : Search for content and enter it.
- : Translate text and enter it.
- : Enter your personal information registered to Samsung Pass.
- : Share music links.
- : Share video links.
- : Enter emojis.
- : Attach animated GIFs.
-  /  / : Enter stickers.
- : Change the keyboard size.
- : Open the text editing panel.

 Some features may not be available depending on the service provider or model.

Copying and pasting

- 1 Tap and hold over text.
- 2 Drag  or  to select the desired text, or tap **Select all** to select all text.
- 3 Tap **Copy** or **Cut**.
The selected text is copied to the clipboard.
- 4 Tap and hold where the text is to be inserted and tap **Paste**.
To paste text that you have previously copied, tap **Clipboard** and select the text.



Apps and features

Installing or uninstalling apps

Galaxy Store

Purchase and download apps. You can download apps that are specialised for Samsung Galaxy devices.

Launch the **Galaxy Store** app. Browse apps by category or tap **Q** to search for a keyword.

-  • This app may not be available depending on the service provider or model.
- To change the auto update settings, tap **Menu** →  → **Auto update apps**, and then select an option.

Play Store

Purchase and download apps.

Launch the **Play Store** app. Browse apps by category or search for apps by keyword.

-  To change the auto update settings, tap your account icon, tap **Settings** → **Network preferences** → **Auto-update apps**, and then select an option.

Managing apps

Uninstalling or disabling apps

Tap and hold an app and select an option.

- **Uninstall:** Uninstall downloaded apps.
- **Disable:** Disable selected default apps that cannot be uninstalled from the device.

-  Some apps may not support this feature.

Enabling apps

Launch the **Settings** app, tap **Apps** →  → **Disabled** → **OK**, select an app, and then tap **Enable**.

Setting app permissions

For some apps to operate properly, they may need permission to access or use information on your device.

To view your app permission settings, launch the **Settings** app and tap **Apps**. Select an app and tap **Permissions**. You can view the app's permissions list and change its permissions.

To view or change app permission settings by permission category, launch the **Settings** app and tap **Apps** → ⋮ → **Permission manager**. Select an item and select an app.



 If you do not grant permissions to apps, the basic features of the apps may not function properly.

Phone

Introduction

Make or answer voice and video calls.

Making calls

- 1 Launch the **Phone** app and tap **Keypad**.
- 2 Enter a phone number.
- 3 Tap  to make a voice call, or tap  or  to make a video call.

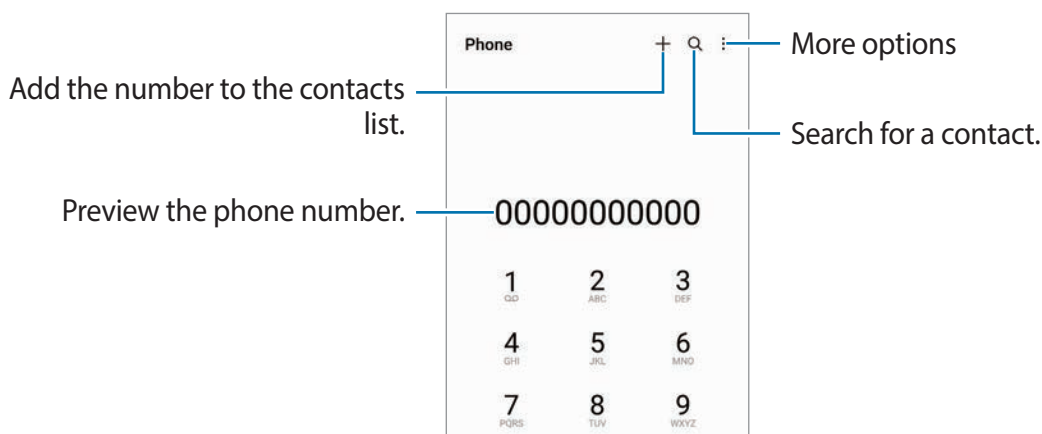

Making calls from call logs or contacts list

Launch the **Phone** app, tap **Recents** or **Contacts**, and then swipe to the right on a contact or a phone number to make a call.

If this feature is deactivated, tap  → **Settings** → **Other call settings**, and then tap the **Swipe to call or text** switch to activate it.

Using speed dial

To set a number to speed dial, launch the **Phone** app, tap **Keypad** or **Contacts** →  → **Speed dial numbers**, select a speed dial number, and then add a phone number.

To make a call, tap and hold a speed dial number on the keypad. For speed dial numbers 10 and up, tap the first digit(s) of the number, and then tap and hold the last digit.

For example, if you set the number **123** as a speed dial number, tap **1**, tap **2**, and then tap and hold **3**.

Making an international call

- 1 Launch the **Phone** app and tap **Keypad**.
- 2 Tap and hold **0** until the + sign appears.
- 3 Enter the country code, area code, and phone number, and then tap .

Receiving calls



Answering a call

When a call comes in, drag  outside the large circle.

Rejecting a call



When a call comes in, drag  outside the large circle.

To send a message when rejecting an incoming call, drag the **Send message** bar upwards and select a message to send.

To create various rejection messages, launch the **Phone** app, tap  → **Settings** → **Quick decline messages**, enter a message, and then tap .

Blocking phone numbers



Block calls from specific numbers added to your block list.

- 1 Launch the **Phone** app and tap  → **Settings** → **Block numbers**.
- 2 Tap **Recents** or **Contacts**, select contacts or phone numbers, and then tap **Done**.
To manually enter a number, tap **Add phone number**, enter a phone number, and then tap .

When blocked numbers try to contact you, you will not receive notifications. The calls will be logged in the call log.

-  You can also block incoming calls from people that do not show their caller ID. Tap the **Block unknown/private numbers** switch to activate the feature.

Options during calls

- **Add call:** Dial a second call. The first call will be put on hold. When you end the second call, the first call will be resumed.
 - **Hold call:** Hold a call.
 - **Bluetooth:** Switch to a Bluetooth headset if it is connected to the device.
 - **Speaker:** Activate or deactivate the speakerphone. When using the speakerphone, keep the device away from your ears.
 - **Mute:** Turn off the microphone so that the other party cannot hear you.
 - **Keypad / Hide:** Open or close the keypad.
 -  : End the current call.
 - **Camera:** During a video call, turn off the camera so that the other party cannot see you.
 - **Switch:** During a video call, switch between the front and rear cameras.
-  Some features may not be available depending on the service provider or model.

Contacts

Introduction

Create new contacts or manage contacts on the device.

Adding contacts

Creating a new contact

- 1 Launch the **Contacts** app and tap **+**.
- 2 Select a storage location.
- 3 Enter contact information and tap **Save**.

Importing contacts

Add contacts by importing them from other storages to your device.

- 1 Launch the **Contacts** app and tap **☰** → **Manage contacts** → **Import or export contacts** → **Import**.
- 2 Follow the on-screen instructions to import contacts.

Syncing contacts with your web accounts





Sync your device contacts with online contacts saved in your web accounts, such as your Samsung account.

- 1 Launch the **Settings** app, tap **Accounts and backup** → **Manage accounts** and select the account to sync with.
- 2 Tap **Sync account** and tap the **Contacts** switch to activate it.

Searching for contacts

Launch the **Contacts** app. Tap **Q** at the top of the contacts list and enter search criteria.

Tap the contact. Then take one of the following actions:

-  : Make a voice call.
-  /  : Make a video call.
-  : Compose a message.
-  : Compose an email.

Deleting contacts

1 Launch the **Contacts** app and tap  → **Delete contacts**.

2 Select contacts and tap **Delete**.

To delete contacts one by one, tap a contact from the contacts list and tap **More** → **Delete**.

Sharing contacts

You can share contacts with others by using various sharing options.

1 Launch the **Contacts** app and tap  → **Share contacts**.

2 Select contacts and tap **Share**.

3 Select a sharing method.

Creating groups

You can add groups, such as family or friends, and manage contacts by group.

1 Launch the **Contacts** app and tap  → **Groups** → **Create group**.

2 Follow the on-screen instructions to create a group.

Merging duplicate contacts

If your contacts list includes duplicate contacts, merge them into one to streamline your contacts list.

1 Launch the **Contacts** app and tap  → **Manage contacts** → **Merge contacts**.

2 Tick contacts and tap **Merge**.



Messages

Introduction

Send and view messages by conversation.

You may incur additional charges for sending or receiving messages when you are roaming.

Sending messages

- 1 Launch the **Messages** app and tap .
- 2 Add recipients and enter a message.
To record and send a voice message, tap and hold , say your message, and then release your finger. The recording icon appears only while the message input field is empty.
- 3 Tap  to send the message.

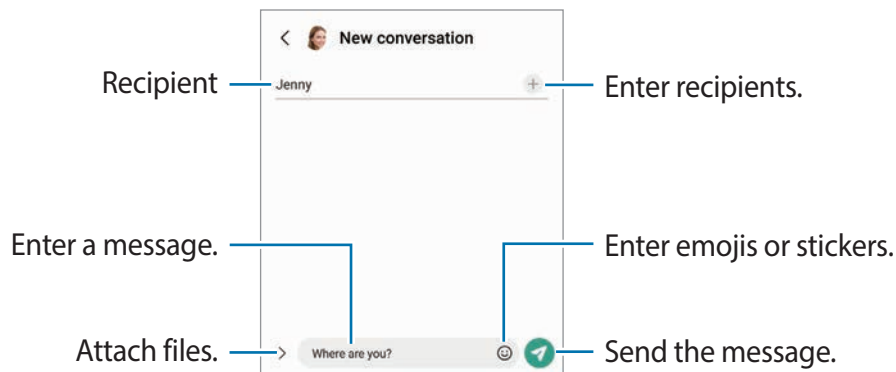



Viewing messages

- 1 Launch the **Messages** app and tap **Conversations**.
- 2 On the messages list, select a contact or a phone number.
 - To reply to the message, tap the message input field, enter a message, and then tap .
 - To adjust the font size, spread two fingers apart or pinch on the screen.

Sorting messages

You can sort messages by category and manage them easily.

Launch the **Messages** app and tap **Conversations** → .

If the category option does not appear, tap  → **Settings** and tap the **Conversation categories** switch to activate it.

Deleting messages

Tap and hold a message to delete, then tap **Delete**.

Changing message settings

Launch the **Messages** app, tap  → **Settings**. You can block unwanted messages, change notification settings, and more.

Internet

Browse the Internet to search for information and bookmark your favourite webpages to access them conveniently.

- 1 Launch the **Internet** app.
- 2 Enter the web address or a keyword, and then tap **Go**.

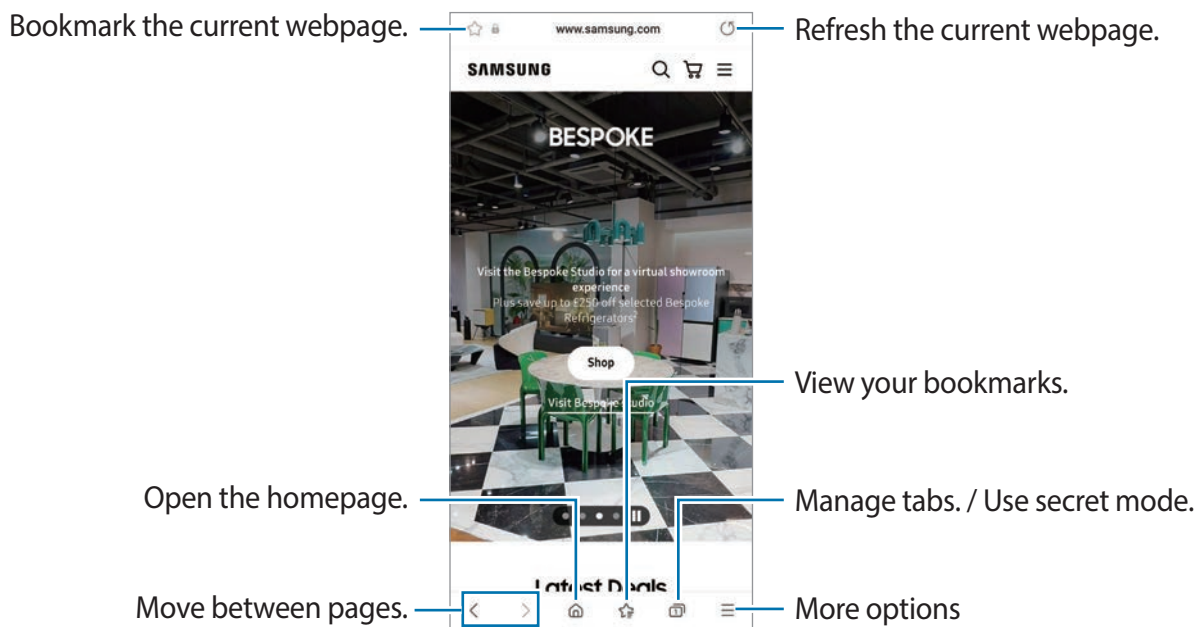

To view the toolbars, drag your finger downwards slightly on the screen.

To switch between tabs quickly, swipe to the left or right on the address field.



Using secret mode

If you set a password for secret mode, you can prevent others from viewing your search history, browsing history, bookmarks, and saved pages.

- 1 Tap  → **Turn on Secret mode**.
- 2 Tap the **Lock Secret mode** switch to activate it, tap **Start**, and then set a password for secret mode.
In secret mode, the device will change the colour of the toolbars. To deactivate secret mode, tap  → **Turn off Secret mode**.

 In secret mode, you cannot use some features, such as screen capture.

Camera

Introduction

Take pictures and record videos using various modes and settings.

Camera etiquette

- Do not take pictures or record videos of other people without their permission.
- Do not take pictures or record videos where legally prohibited.
- Do not take pictures or record videos in places where you may violate other people's privacy.

Taking pictures

- 1 Launch the **Camera** app.

You can also launch the app by pressing the Side key twice quickly or dragging  to the left on the locked screen.

-  • Some camera features are not available when you launch the **Camera** app from the locked screen or when the screen is turned off while the screen lock method is set.
- The camera automatically shuts off when unused.
 - Some methods may not be available depending on the service provider or model.

- 2 Tap the image on the preview screen where the camera should focus.

To adjust the brightness of pictures, drag the adjustment bar that appears above or below the circular frame.

3 Tap  to take a picture.

To change the shooting mode, drag the shooting modes list to the left or right, or swipe to the left or right on the preview screen.

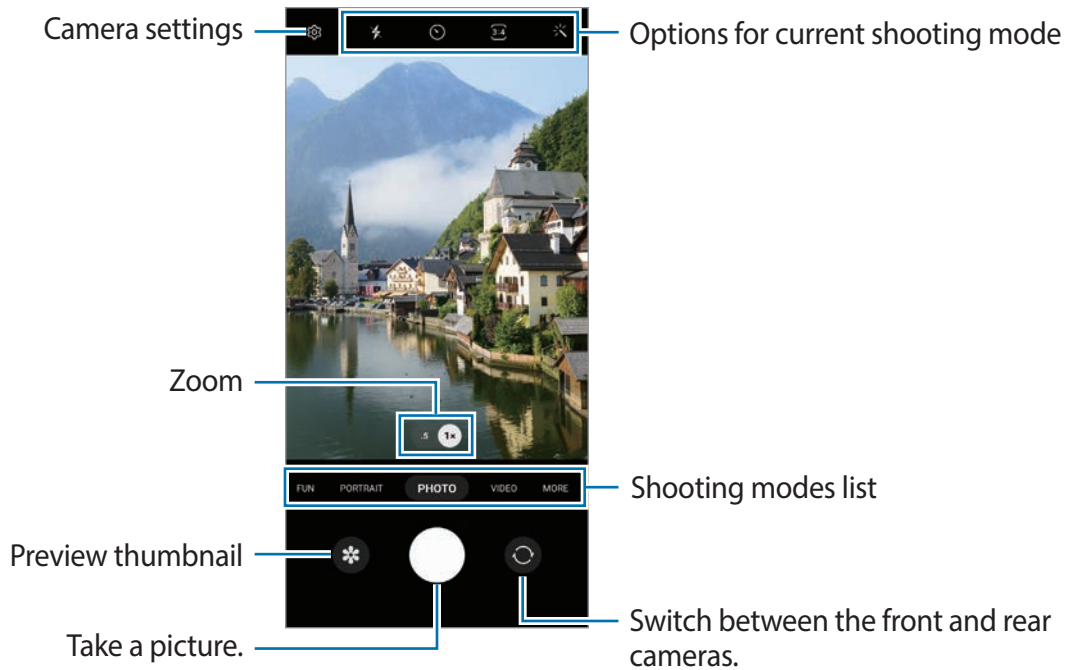

- The preview screen may vary depending on the shooting mode and which camera is being used.
- The focus may not be clear if the subject is close. Take pictures or videos from a good distance.
- If pictures you take appear blurry, clean the camera lens and try again.
- Make sure that the lens is not damaged or contaminated. Otherwise, the device may not work properly in some modes that require high resolutions.
- Your device's camera features a wide-angle lens. Minor distortion may occur in wide-angle pictures or videos and does not indicate device performance problems.
- The maximum capacity for recording a video may vary depending on the resolution.
- The camera may fog up or form condensation if the device is exposed to sudden changes in air temperature, due to the difference in temperature outside and inside the camera cover. Try to avoid such conditions when planning to use the camera. If fogging does occur, allow the camera to dry naturally at room temperature before taking pictures or recording videos, otherwise results may look blurry.

Using zoom features

Select **.5/1/2** or drag it to the left or right to zoom in or out. Alternatively, spread two fingers apart on the screen to zoom in, and pinch to zoom out.

- **.5**: The Ultra wide camera lets you take wide-angle pictures or record wide-angle videos of things like landscapes.
- **1**: The wide-angle camera lets you take basic pictures or record normal videos.
- **2**: The telephoto camera lets you take pictures or record videos by enlarging the subject. (SM-M336B/DS, SM-M336BU/DS)

 Zoom features are available only when using the rear camera.

Locking the focus (AF) and exposure (AE)

You can lock the focus or exposure on a selected area to prevent the camera from automatically adjusting based on changes to the subjects or light sources.

Tap and hold the area to focus, the AF/AE frame will appear on the area and the focus and exposure setting will be locked. The setting remains locked even after you take a picture.

















 This feature may not be available depending on the shooting mode.

Using the camera button

- Tap and hold the camera button to record a video.
- To take burst shots, swipe the camera button to the edge of the screen and hold it.
- If you add another camera button, you can move it anywhere on the screen and take pictures more conveniently. On the preview screen, tap  → **Shooting methods** and tap the **Floating Shutter button** switch to activate it.

Options for current shooting mode

On the preview screen, use the following options.

-  /  : Activate or deactivate the flash.
-  : Select the length of the delay before the camera automatically takes a picture.
-  : Select an aspect ratio and resolution for pictures.
-  : Activate or deactivate the super steady feature.
-  : Select a frame rate.
-  : Select an aspect ratio for pictures and videos.
-  : Select a resolution for videos.
-  : Apply a filter effect or beauty effects.
-  : Select a metering method. This determines how light values are calculated.  **Centre-weighted metering** uses the light in the centre portion of the shot to calculate the exposure of the shot.  **Spot metering** uses the light in a concentrated centre area of the shot to calculate the exposure of the shot.  **Matrix metering** averages the entire scene.
-  : Adjust the colour tone.
-  : In **FOOD** mode, focus on a subject inside the circular frame and blur the image outside the frame.
-  : In **FOOD** mode, adjust the colour tone.
-  : Customise the shooting options when taking single take shots.

 The available options may vary depending on the model or shooting mode.

Photo mode

The camera adjusts the shooting options automatically depending on the surroundings to capture pictures easily.

On the shooting modes list, tap **PHOTO** and tap  to take a picture.

Taking high-resolution pictures

Take high-resolution pictures.

In the shooting options, tap  →  and take a picture.

 The resolution may vary depending on the model.

Shot suggestions

The camera suggests the ideal composition for the picture by recognising the position and angle of your subject.

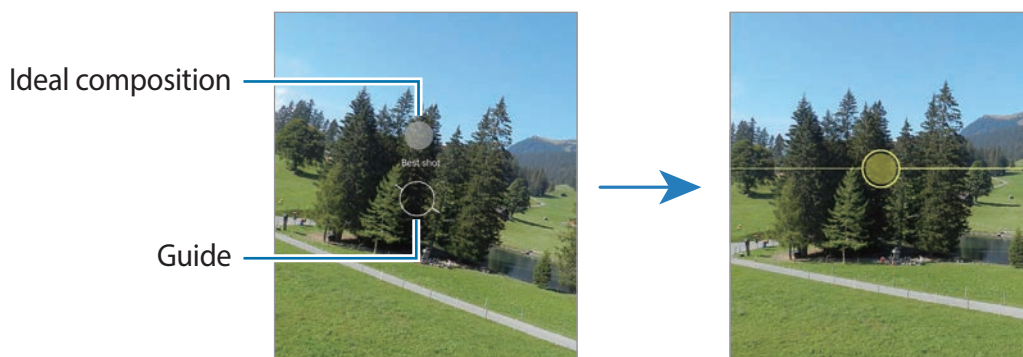

On the preview screen, tap  and tap the **Shot suggestions** switch to activate it.

- 1 On the shooting modes list, tap **PHOTO**.
A guide will appear on the preview screen.
- 2 Point the guide at the subject.
The camera recognises the composition, and the recommended composition appears on the preview screen.
- 3 Move the device so the guide matches the recommended composition.
When the ideal composition is achieved, the guide will change to yellow.
- 4 Tap  to take a picture.



Taking selfies

You can take self-portraits with the front camera.

- 1 On the preview screen, swipe upwards or downwards, or tap  to switch to the front camera for self-portraits.
- 2 Face the front camera lens.
To take self-portraits with a wide-angle shot of the landscape or people, tap .
- 3 Tap  to take a picture.





Applying filter and beauty effects

You can select a filter effect and modify facial features, such as your skin tone or face shape, before taking a picture.

- 1 On the preview screen, tap .
- 2 Select effects and take a picture.
If you use the My filters feature, you can create your own filter using an image with a colour tone you like from **Gallery**.

Video mode

The camera adjusts the shooting options automatically depending on the surroundings to record videos easily.

- 1 On the shooting modes list, tap **VIDEO** and tap 
 - To switch between the front and rear cameras while recording, swipe upwards or downwards on the preview screen or tap .
 - To capture an image from the video while recording, tap .
- 2 Tap  to stop recording the video.

Stabilising videos (Super steady) (SM-E236B/DS, SM-M236B/DS)



If there is a lot of shaking when recording videos, use the Super steady feature for further video stabilisation.

Tap **VIDEO** on the shooting modes list, tap  on the shooting options to activate it, and then record a video.

Single take mode

Take various pictures and videos in just one shot.

Your device automatically selects the best shot and creates pictures with filters or videos with certain sections repeated.

- 1 On the shooting modes list, tap **MORE** → **SINGLE TAKE**.
- 2 Tap  to capture the scene you want.
- 3 When you are finished, tap the preview thumbnail.
To view other results, drag the — icon upwards. To save the results individually, tap **Select**, tick the items you want, and then tap .

Customise the shooting options.

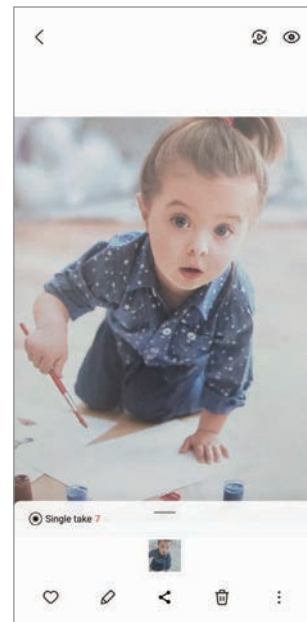
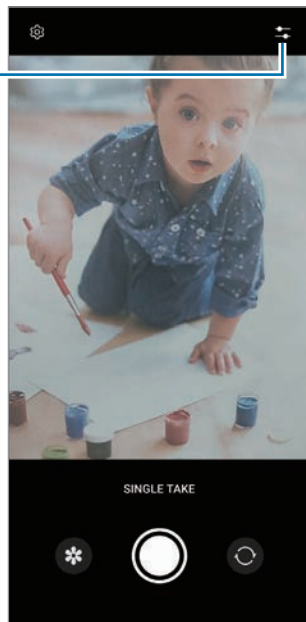

Fun mode

Take pictures or record videos with various effects.

- 1 On the shooting modes list, tap **FUN**.
- 2 Select an effect.
- 3 Tap the effect button to take a picture.
To record a video, tap and hold the effect button.

Portrait mode

The camera allows you to take pictures where the background is blurred and the subject stands out clearly. You can also apply a background effect and edit it after taking a picture.

- 1 On the shooting modes list, tap **PORTRAIT**.
- 2 Drag the background blur adjustment bar to adjust the blur level.
- 3 When **Ready** appears on the preview screen, tap  to take a picture.



Background blur adjustment bar



- Use this feature in a place that has sufficient light.
- The background blur may not be applied properly in the following conditions:
 - The device or the subject is moving.
 - The subject is thin or transparent.
 - The subject has a similar colour to the background.
 - The subject or background is plain.

Pro mode

Capture pictures while manually adjusting various shooting options, such as exposure value and ISO value.

On the shooting modes list, tap **MORE** → **PRO**. Select options and customise the settings, and then tap  to take a picture.

Available options

-  : Reset the settings.
- **ISO**: Select an ISO value. This controls camera light sensitivity. Low values are for stationary or brightly lit objects. Higher values are for fast-moving or poorly lit objects. However, higher ISO settings can result in noise in pictures.
- **SPEED**: Adjust the shutter speed. A slow shutter speed allows more light in, so the picture becomes brighter. This is ideal for pictures of scenery or pictures taken at night. A fast shutter speed allows less light in. This is ideal for taking pictures of fast-moving subjects.
- **EV**: Change the exposure value. This determines how much light the camera's sensor receives. For low-light situations, use a higher exposure.
- **FOCUS**: Change the focus mode. Drag the adjustment bar to manually adjust the focus.
- **WB**: Select an appropriate white balance, so images have a true-to-life colour range. You can set the colour temperature.

Separating the focus area and the exposure area

You can separate the focus area and the exposure area.

Tap and hold the preview screen. The AF/AE frame will appear on the screen. Drag the frame to the area where you want to separate the focus area and the exposure area.





Night mode

Take a picture in low-light conditions, without using the flash. When you use a tripod, you can get brighter and steadier results.

- 1 On the shooting modes list, tap **MORE** → **NIGHT**.
- 2 Tap  and hold your device steady until shooting is complete.



Food mode

Take pictures of food with more vibrant colours.

- 1 On the shooting modes list, tap **MORE** → **FOOD**.
- 2 Tap the screen and drag the circular frame over the area to highlight.
The area outside the circular frame will be blurred.
To resize the circular frame, drag a corner of the frame.
- 3 Tap  and drag the adjustment bar to adjust the colour tone.
- 4 Tap  to take a picture.

Panorama mode

Using panorama mode, take a series of pictures and then stitch them together to create a wide scene.

- 1 On the shooting modes list, tap **MORE** → **PANORAMA**.
- 2 Tap  and move the device slowly in one direction.
Keep the image within the frame on the camera's viewfinder. If the preview image is out of the guide frame or you do not move the device, the device will automatically stop taking pictures.
- 3 Tap  to stop taking pictures.

 Avoid taking pictures of indistinct backgrounds, such as an empty sky or a plain wall.



Macro mode

Take pictures of subjects at close range.

On the shooting modes list, tap **MORE** → **MACRO**.

Super Slow-mo mode

Super slow motion is a feature that records a quickly passing moment slowly so that you can appreciate it later.

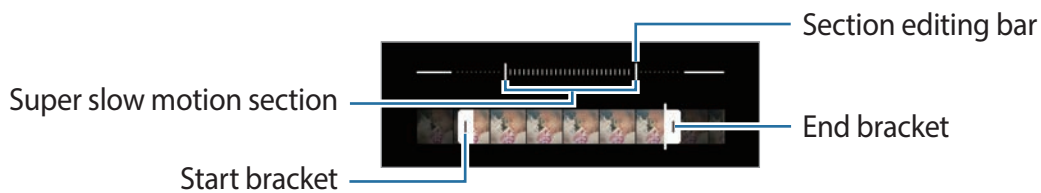

- 1 On the shooting modes list, tap **MORE** → **SUPER SLOW-MO** and tap  to record a video. The device will capture the moment in super slow motion and save it as a video.
- 2 On the preview screen, tap the preview thumbnail. To edit the super slow motion section, tap  and drag the section editing bar to the left or right.



-  Use this feature in a place that has sufficient light. When recording a video indoors with insufficient or poor lighting, the screen may appear dark or be grainy. The screen may flicker in certain lighting conditions, such as in places with fluorescent lighting.

Slow motion mode



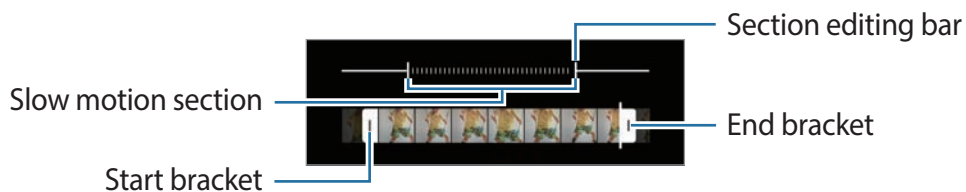

Record a video for viewing it in slow motion. You can specify sections of your videos to be played in slow motion.

- 1 On the shooting modes list, tap **MORE** → **SLOW MOTION** and tap  to record a video.
- 2 When you are finished recording, tap  to stop.
- 3 On the preview screen, tap the preview thumbnail. The fast section of the video will be set as a slow motion section and the video will start playing. Up to two slow motion sections will be created based on the video. To edit the slow motion section, tap  and drag the section editing bar to the left or right.



Hyperlapse mode

Record scenes, such as passing people or cars, and view them as fast-motion videos.

- 1 On the shooting modes list, tap **MORE** → **HYPERLAPSE**.
- 2 Tap  and select a frame rate option.
If you set the frame rate to , the device will automatically adjust the frame rate according to the changing rate of the scene.
- 3 Tap  to start recording.
- 4 Tap  to finish recording.

Customising camera settings

On the preview screen, tap . Some options may not be available depending on the shooting mode.

Intelligent features

- **Scene optimiser:** Set the device to adjust the colour settings and apply the optimised effect automatically depending on the subject or scene.
- **Shot suggestions:** Set the device to suggest the ideal composition for the picture by recognising the position and angle of your subject.
- **Scan QR codes:** Set the device to scan QR codes from the preview screen.

Pictures

- **Swipe Shutter button to:** Select an action to perform when you swipe the camera button to the edge of the screen and hold it.
- **High efficiency pictures:** Take pictures in the High Efficiency Image Format (HEIF).

Selfies

- **Save selfies as previewed:** Set the device to save pictures as they appear on the preview screen when taken with the front camera without flipping them.

Videos

- **Reduce file size:** You can record videos in the High Efficiency Video Codec (HEVC) format. Your HEVC videos will be saved as compressed files to conserve the device's memory.
 -  • You may not be able to play the HEVC videos on other devices or share them online.
 - Super slow motion and slow motion videos cannot be recorded in the HEVC format.

- **Auto FPS:** Set the device to record brighter videos in low-light conditions by automatically optimising the frame rate.
- **Video stabilisation:** Activate anti-shake to reduce or eliminate blurry image resulting from camera shake while recording a video.

General

- **Auto HDR:** Take pictures with rich colours and reproduce details even in bright and dark areas.
- **Grid lines:** Display viewfinder guides to help composition when selecting subjects.
- **Location tags:** Attach a GPS location tag to the picture.
 -  • GPS signal strength may decrease in locations where the signal is obstructed, such as between buildings or in low-lying areas, or in poor weather conditions.
 - Your location may appear on your pictures when you upload them to the Internet. To avoid this, deactivate the location tag setting.
- **Shooting methods:** Select additional shooting methods for taking a picture or recording a video.
- **Settings to keep:** Keep the last settings you used, such as the shooting mode, when you launch the camera.
- **Storage location:** Select the memory location for storage. This feature will appear when you insert a memory card.
- **Watermark:** Add a watermark in the bottom left corner when taking pictures.
- **Show Snapchat Lenses in Fun mode:** Set the device to take pictures or record videos with various effects using unique Snapchat Lenses.

Privacy

- **Privacy Notice:** View the privacy notice.
- **Permissions:** View the permissions required to use the Camera app.
- **Reset settings:** Reset the camera settings.
- **Contact us:** Ask questions or view frequently asked questions.
- **About Camera:** View the Camera app version and legal information.

 Some features may not be available depending on the model.

Gallery

Introduction

View images and videos stored in your device. You can also manage images and videos by album or create stories.

Using Gallery

Launch the **Gallery** app.

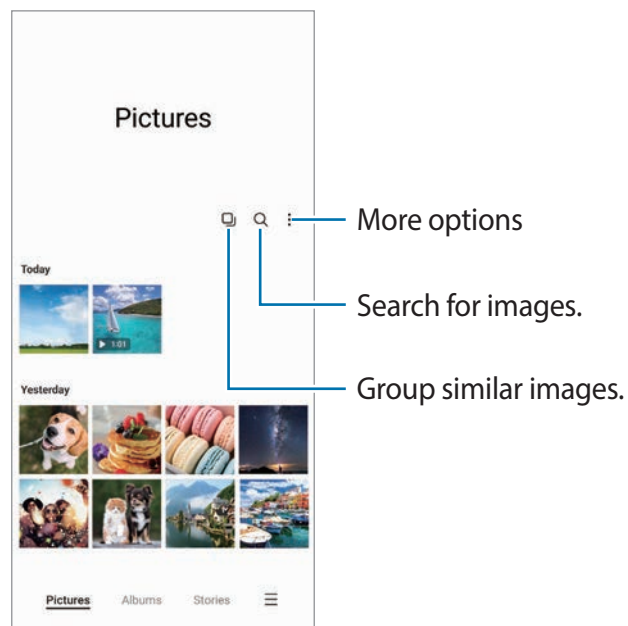

Grouping similar images

Launch the **Gallery** app and tap  to group similar images and display only the best shots as a preview of the images. When you tap the image preview, you can view all the images in the group.

Viewing images

Launch the **Gallery** app and select an image. To view other files, swipe to the left or right on the screen.

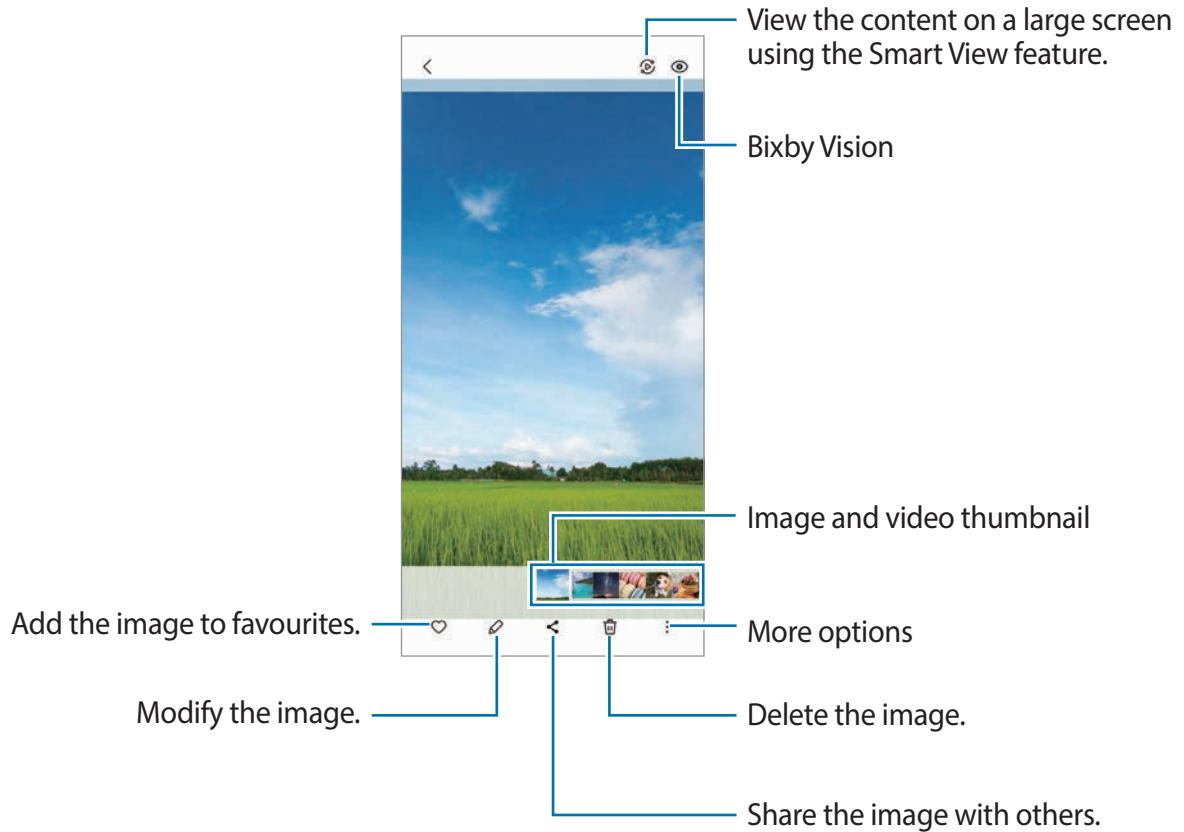

Cropping enlarged images

- 1 Launch the **Gallery** app and select an image.
- 2 Spread two fingers apart on the area you want to save and tap .
The cropped area will be saved as a file.

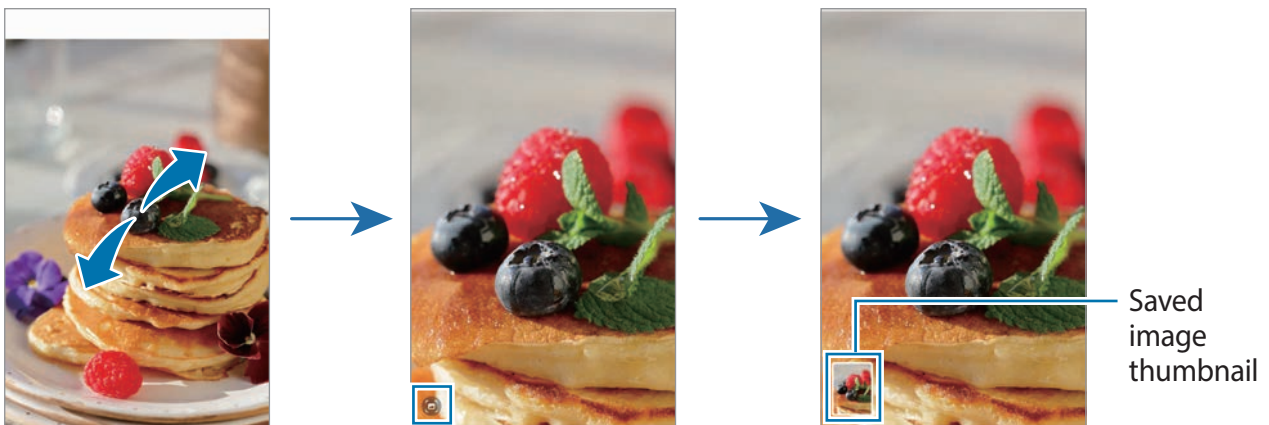

Viewing videos

Launch the **Gallery** app and select a video to play. To view other files, swipe to the left or right on the screen.

To use more options during playback, tap  → **Open in Video player**.

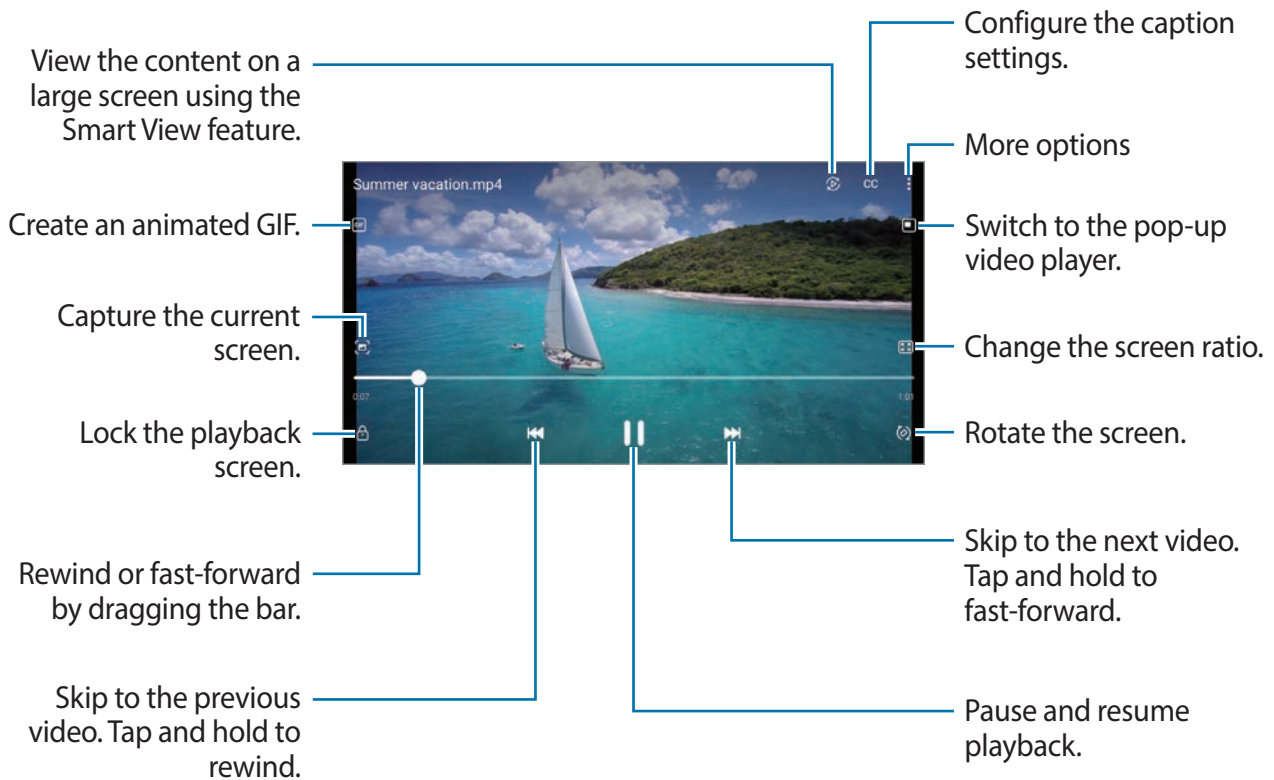

Drag your finger up or down on the left side of the playback screen to adjust the brightness, or drag your finger up or down on the right side of the playback screen to adjust the volume.

To rewind or fast-forward, swipe to the left or right on the playback screen.

Albums

Create albums and sort your images and videos.

- 1 Launch the **Gallery** app and tap **Albums** →  → **Create album** to create an album.
- 2 Select the album, tap **Add items**, and then copy or move the images or videos you want.

Stories

When you capture or save images and videos, the device will read their date and location tags, sort the images and videos, and then create stories.

Launch the **Gallery** app, tap **Stories**, and then select a story.

To add or delete images or videos, select a story and tap  → **Add** or **Edit**.

Syncing images and videos

Launch the **Gallery** app, tap  → **Settings** → **Sync with OneDrive**, and then follow the on-screen instructions to complete the sync. The **Gallery** app and the cloud will be synced.

When your **Gallery** app is synced with the cloud, pictures and videos you take will also be saved in the cloud. You can view images and videos saved in the cloud in your **Gallery** app and from other devices.

 When you connect your Samsung account and Microsoft account, you can set the cloud storage as Microsoft OneDrive.

Deleting images or videos

Launch the **Gallery** app, tap and hold an image, a video, or a story to delete, and then tap **Delete**.

Using the recycle bin feature

You can keep the deleted images and videos in the recycle bin. The files will be deleted after a certain period.

Launch the **Gallery** app, tap  → **Settings**, and then tap the **Recycle bin** switch to activate it.

To view files in the recycle bin, launch the **Gallery** app and tap  → **Recycle bin**.

AR Zone

Introduction

AR Zone provides you AR related features. Choose a feature and capture fun pictures or videos.

Launching AR Zone

Use the following methods to launch AR Zone:

- Launch the **AR Zone** app.
- Launch the **Camera** app and tap **MORE** → **AR ZONE**.

 Some features may not be available depending on the service provider or model.

AR Emoji Studio

Create emojis any way you want and have fun using them in various features.

Creating an AR Emoji

- 1 Launch the **AR Zone** app and tap **AR Emoji Studio**.
 - 2 You can pick a pre-made emoji to get started quickly. Swipe to the left or right, select an emoji, and then tap .
- If you want to make your own emoji, take a selfie or select an image.

3 Follow the on-screen instructions to create an emoji.

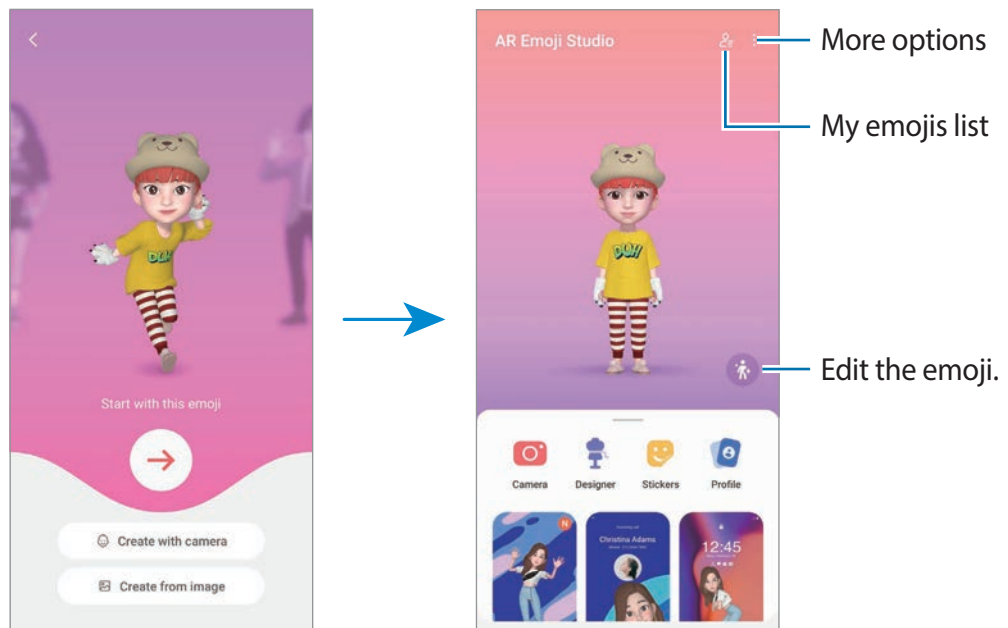

Selecting an AR emoji to use

Launch the **AR Zone** app, tap **AR Emoji Studio** → , and then select an emoji you want.

Deleting AR emojis

Launch the **AR Zone** app, tap **AR Emoji Studio** →  → , tick emojis to delete, and then tap **Delete**.

Creating an AR emoji short video and decorating your device with it

You can create a short video with an emoji and use it as a wallpaper or call background image.

- 1 Launch the **AR Zone** app and tap **AR Emoji Studio**.
- 2 Select **Create video**, **Call screen**, or **Lock screen**.
- 3 Select a template you want.
To change the background image, tap .
- 4 Tap **Save** to save the video.
You can view the saved videos in **Gallery**.
- 5 To use the video directly, select an option at the bottom of the screen.

Creating your contact profile with an AR emoji

Use an emoji as your profile picture for your Samsung account and in the **Contacts** app. You can choose from various poses or create your own expressions.

- 1 Launch the **AR Zone** app and tap **AR Emoji Studio**.
- 2 Tap **Profile** and select an emoji.
- 3 Tap  to capture your expression or select a pose you want.
- 4 Tap **Done** → **Save**.

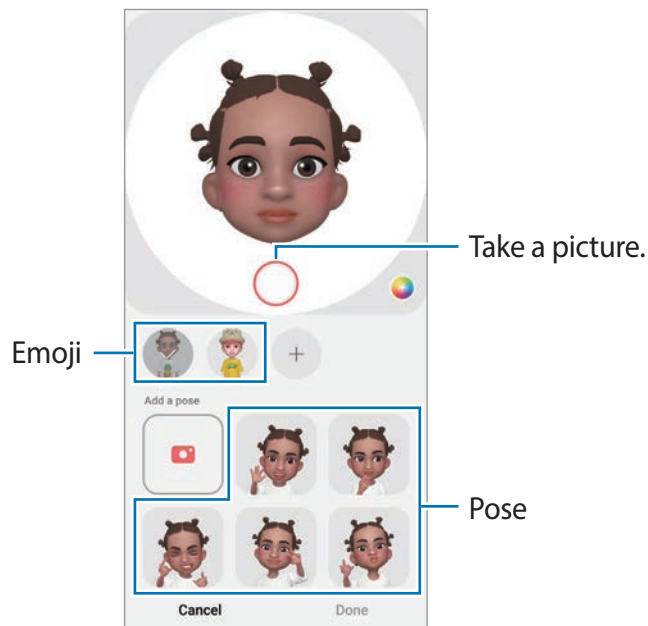

AR Emoji Camera

Create fun pictures or videos with emojis using various shooting modes.

- 1 Launch the **AR Zone** app and tap **AR Emoji Camera**.
- 2 Select the emoji and the mode you want to use. The available modes may vary depending on the emoji you select.
 - **SCENE**: The emoji mimics your expressions. You can also change the background image.
 - **MASK**: The emoji's face appears over your face so it looks like you are wearing a mask.

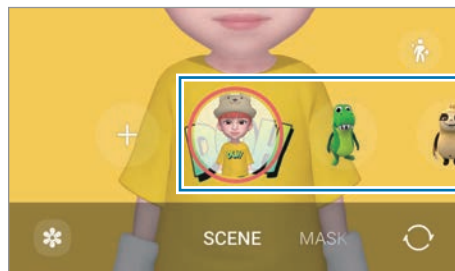

- 3 Tap the emoji icon to take a picture, or tap and hold the icon to record a video. You can view and share the pictures and videos that you have captured in **Gallery**.

AR Emoji Stickers

Create your own stickers with your emoji's expressions and actions. You can use your emoji stickers when sending messages or on a social network.

Creating your own stickers

- 1 Launch the **AR Zone** app and tap **AR Emoji Stickers**.
- 2 Tap **+** at the top of the stickers list.
- 3 Edit stickers how you want and tap **Save**.
You can view the stickers you have created by tapping **Custom**.

Deleting AR emoji stickers

Launch the **AR Zone** app and tap **AR Emoji Stickers** → **⋮** → **Delete stickers**. Select the emoji stickers to delete and tap **Delete**.

Using your AR emoji stickers in chats

You can use your emoji stickers during a conversation via messages or on a social network. The following actions are an example of using your emoji stickers in the **Messages** app.

- 1 While composing a message in the **Messages** app, tap 😊 on the Samsung keyboard.
- 2 Tap the emoji icon.
- 3 Select one of your emoji stickers.
The emoji sticker will be inserted.

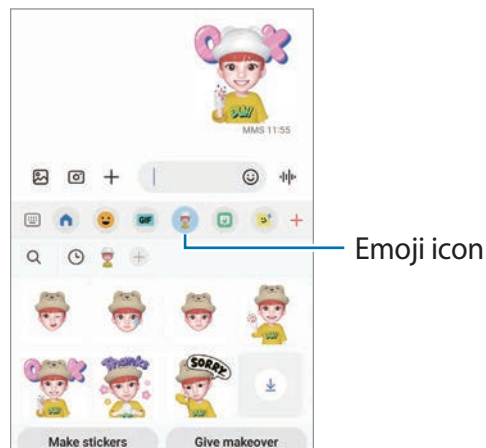

AR Doodle

Record fun videos with virtual handwriting or drawings on faces or anywhere else. When the camera recognises a face or space, the doodles on the face will follow the face as it moves, and the doodles in the space will be fixed in the same place even if the camera moves.

1 Launch the **AR Zone** app and tap **AR Doodle**.

When the camera recognises the subject, the recognition area will appear on the screen.

2 Tap  and write or draw in the recognition area.

- If you switch to the rear camera, you can also write or draw outside the recognition area.
- If you tap  and then begin to doodle, you can record yourself doodling.

Delete doodle.

Recognition area

Text

GIF

Pen tool

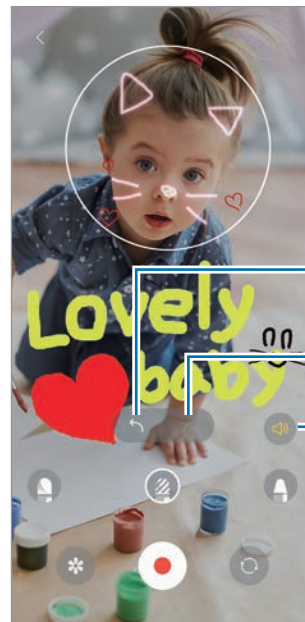
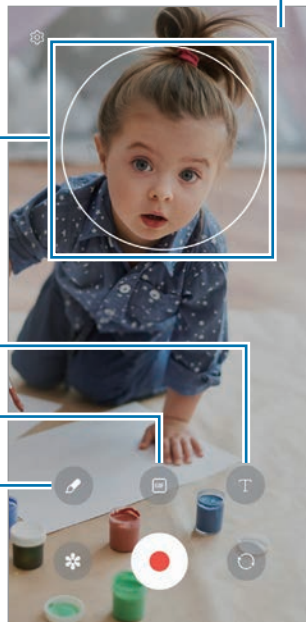

Undo

Redo

Turn the sound effect on or off.

3 Tap  to record a video.

4 Tap  to stop recording the video.

You can view and share the video in **Gallery**.



The available features on the preview screen may vary depending on which camera is being used.

Bixby Vision (SM-M336B/DS, SM-M336BU/DS)

Introduction

Bixby Vision is a service that provides various features based on image recognition. You can use Bixby Vision to quickly search for information by recognising objects. Use a variety of useful Bixby Vision features.

-  • This feature may not be available or you may not get correct search results depending on the image size, format, or resolution.
- Samsung is not responsible for the product information provided by Bixby Vision.

Launching Bixby Vision



Launch Bixby Vision using one of these methods.

- In the **Camera** app, tap **MORE** on the shooting modes list and tap **BIXBY VISION**.
- In the **Gallery** app, select an image and tap .
- In the **Internet** app, tap and hold an image and tap **Search with Bixby Vision**.
- If you added the Bixby Vision app icon to the Apps screen, launch the **Bixby Vision** app.

Using Bixby Vision

1 Launch Bixby Vision.

2 Select a feature you want to use.

-  : Recognise text from documents or images and translate it.
-  : Recognise text from documents or images and extract it.
-  : Search for images similar to the recognised object online and related information.

 The available features and search results may vary depending on the region or service provider.

Multi window

Introduction

Multi window lets you run two apps at the same time in the split screen view. You can also run multiple apps at the same time in the pop-up view.

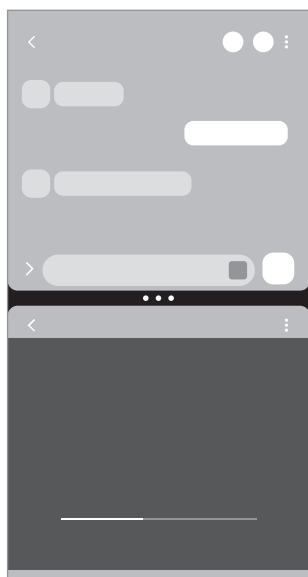

Split screen view

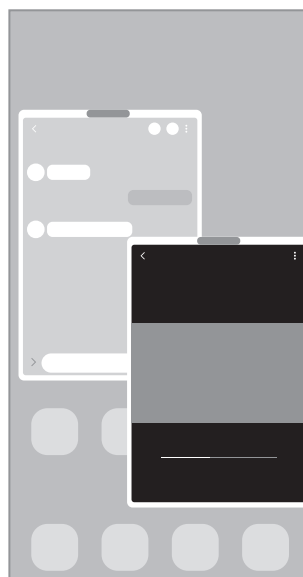

Pop-up view

 Some apps may not support this feature.



Split screen view

- 1 Tap the Recents button to open the list of recently used apps.
- 2 Swipe to the left or right, tap an app's icon, and then tap **Open in split screen view**.
- 3 On the apps list, select another app to launch.

Launching apps from the Edge panel

- 1 While using an app, drag the Edge panel handle towards the centre of the screen.
- 2 Tap and hold an app, drag it to the left, and then drop it where **Drop here to open** appears.

The selected app will launch in the split screen view.

-  You can set to launch an app in the split screen view by tapping it once. Tap  → **Edit** →  and tap **Tap** under **Open in split screen view**. If you tap the **Show recent apps** switch to activate it, you can launch the recently used apps in the split screen view from the Edge panel.

Adding app pairs

Add frequently used apps to the Edge panel to launch them together in the split screen view with a single tap.

- 1 In the split screen view, tap the circles between the app windows.
 - 2 Tap .
- The apps you are using in the split screen view will be saved on the Edge panel as an app pair.

Adjusting the window size

Drag the circles between the app windows to adjust the size of the windows.

When you drag the circles between the app windows to the edge of the screen, the window will be maximised.

Pop-up view

- 1 Tap the Recents button to open the list of recently used apps.
- 2 Swipe to the left or right, tap an app's icon, and then tap **Open in pop-up view**.
The app screen will appear in the pop-up view.
If you tap the Home button while using a pop-up window, the window will be minimised and displayed as an app icon. To use the pop-up window again, tap the app icon.

Launching apps from the Edge panel

- 1 Drag the Edge panel handle towards the centre of the screen.
- 2 Tap and hold an app, drag it to the left, and then drop it where **Drop here for pop-up view** appears.
The selected app will launch in the pop-up view.

Moving pop-up windows

To move a pop-up window, tap the window's toolbar and drag it to a new location.

Samsung Pay

Introduction

Register cards to Samsung Pay to make both online and offline payments quickly and securely.

You can view more information, such as cards that support this feature at www.samsung.com/samsung-pay.



- To make payments with Samsung Pay, the device may be required a connection to a Wi-Fi or mobile network depending on the region.
- This feature may not be available depending on the service provider or model.
- The procedures for the initial setup and card registration may vary depending on the service provider or model.

Setting up Samsung Pay

When running this app for the first time or restart it after performing a data reset, follow the on-screen instructions to complete the initial setup.

- 1 Launch the **Samsung Pay** app.
- 2 Sign in to your Samsung account and read and agree to the terms and conditions.
- 3 Register your fingerprint and a PIN to use when making payments.
This PIN will be used to verify various actions in Samsung Pay, such as making payments and unlocking the app.

Registering cards

Launch the **Samsung Pay** app and follow the on-screen instructions to complete your card registration.

Making payments

- 1 Tap and hold a card image at the bottom of the screen and drag it upwards. Alternatively, launch the **Samsung Pay** app. Then, on the cards list, swipe to the left or right and select a card to use.

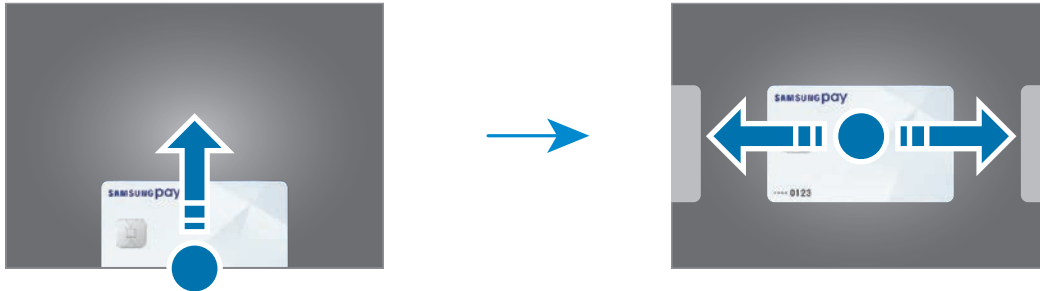

- 2 Scan your fingerprint or enter the payment PIN you set.
 - 3 Touch the back of your device to the card reader.
When the card reader recognises the card information, the payment will be processed.
- Payments may not be processed depending on your network connection.
 - The verification method for payments may vary depending on the card readers.

Cancelling payments

You can cancel payments by visiting the place where you made them.

On the cards list, swipe to the left or right to select the card you used. Follow the on-screen instructions to complete payment cancellation.

Samsung Health

Introduction

Samsung Health helps you manage your wellness and fitness. Set fitness goals, check your progress, and keep track of your overall wellness and fitness. You can also compare your step count records with other Samsung Health users and view health tips.

Visit www.samsung.com/samsung-health for more information.

Using Samsung Health

Launch the **Samsung Health** app. When running this app for the first time or restarting it after performing a data reset, follow the on-screen instructions to complete the setup.

To edit items on the Samsung Health home screen, tap  → **Manage items**.

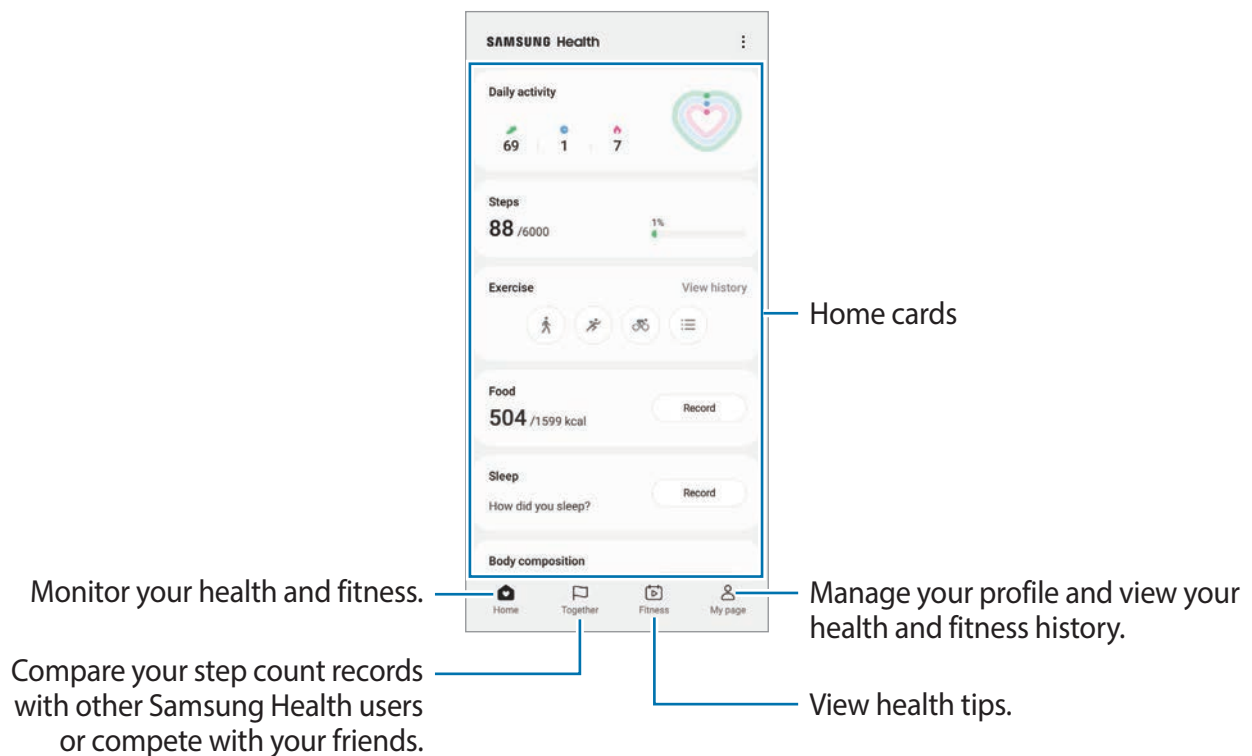

- Some features may not be available depending on the region.
- If you use the steps card while travelling by car or train, vibration may affect your step count.

Samsung Notes

Create notes by entering text from the keyboard or by handwriting or drawing on the screen. You can also insert images or voice recordings into your notes.

Creating notes

- 1 Launch the **Samsung Notes** app, tap , and then create a note.

You can change the input method by tapping  or .

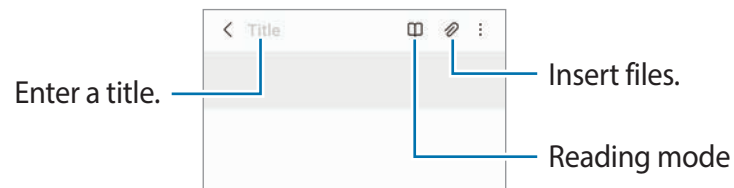

- 2 When you are finished composing the note, tap the Back button to save it.
If you want to save the note in another file format, tap  → **Save as file**.

Deleting notes



Tap and hold a note to delete and tap **Delete**.

Samsung Members

Samsung Members offers support services to customers, such as device problem diagnosis, and lets users submit questions and error reports. You can also share information with others in the Galaxy users' community or view the latest news and tips. **Samsung Members** can help you solve any problems you might encounter while using your device.

Samsung Kids

You can restrict children's access to certain apps, set their usage times, and configure settings to provide a fun and safe environment for children when they use the device.

Open the notification panel, swipe downwards, and then tap  (**Kids**) to activate it. If you cannot find  (**Kids**) on the quick panel, tap  and drag the button over to add it. When starting Samsung Kids for the first time or after performing a data reset, follow the on-screen instructions to complete the setup.

On the Samsung Kids screen, select the app you want to use.

 Your preset screen lock method or your created PIN will be used when activating the **Parental controls** feature or closing Samsung Kids.

Using parental control features

You can configure the settings for Samsung Kids and view the usage history.

On the Samsung Kids screen, tap  → **Parental controls** and enter your unlock code.

Closing Samsung Kids

To close Samsung Kids, tap the Back button or tap  → **Close Samsung Kids**, and then enter your unlock code.

Samsung Global Goals

The Global Goals, which were established by the United Nations General Assembly in 2015, consist of goals that aim to create a sustainable society. These goals have the power to end poverty, fight inequality, and stop climate change.

With Samsung Global Goals, learn more about the global goals and join the movement for a better future.

Samsung TV Plus

Select the channels like you would use a TV and enjoy various video content free of charge.

Launch the **Samsung TV Plus** app.

 This app may not be available depending on the service provider or model.

Galaxy Shop

Access the Samsung website and view various information related to products.

Launch the **Galaxy Shop** app.

 This app may not be available depending on the service provider or model.

Galaxy Wearable (SM-M336B/DS, SM-M336BU/DS)

Galaxy Wearable is an app that allows you to manage your wearable devices. When you connect your device to the wearable device, you can customise the wearable device's settings and apps.



Launch the **Galaxy Wearable** app.

Tap **Start** to connect your device to the wearable device. Follow the on-screen instructions to finish the setup. Refer to the wearable device's user manual for more information about how to connect and use the wearable device with your device.

Calendar



Manage your schedule by entering upcoming events in your planner.

Creating events

- 1 Launch the **Calendar** app and tap  or double-tap a date.
If the date already has saved events or tasks in it, tap the date and tap .
- 2 Enter event details and tap **Save**.

Syncing events with your accounts

- 1 Launch the **Settings** app, tap **Accounts and backup** → **Manage accounts**, and then select the account to sync with.
- 2 Tap **Sync account** and tap the **Calendar** switch to activate it.

To add accounts to sync with, launch the **Calendar** app and tap  →  → **Manage calendars** → . Then, select an account to sync with and sign in. When an account is added, a blue circle is displayed next to the account name.

Reminder

Register to-do items as reminders and receive notifications according to the condition you set.



- To receive more accurate notifications, connect to a Wi-Fi or mobile network.
- To use location reminders, the GPS feature must be activated. Location reminders may not be available depending on the model.

Starting Reminder

Launch the **Calendar** app and tap  → **Reminder**. The Reminder screen will appear and the Reminder app icon () will be added to the Apps screen.

Creating reminders

- 1 Launch the **Reminder** app.
- 2 Tap , enter the details, and then tap **Save**.

Completing reminders

On the reminders list, tap or select a reminder and tap **Complete**.

Restoring reminders

Restore reminders that have been completed.

- 1 On the reminders list, tap  → **Completed**.
- 2 Select a category and tap **Edit**.
- 3 Select a reminder to restore and tap **Restore**.
Reminders will be added to the reminders list and you will be reminded again.

Deleting reminders

To delete a reminder, select a reminder and tap **Delete**. To delete multiple reminders, tap and hold a reminder, tick reminders to delete, and then tap **Delete**.

Radio

Launch the **Radio** app.

Before you use this app, you must connect an earphone, which serves as the radio antenna.

The FM radio scans and saves available stations automatically when running for the first time.

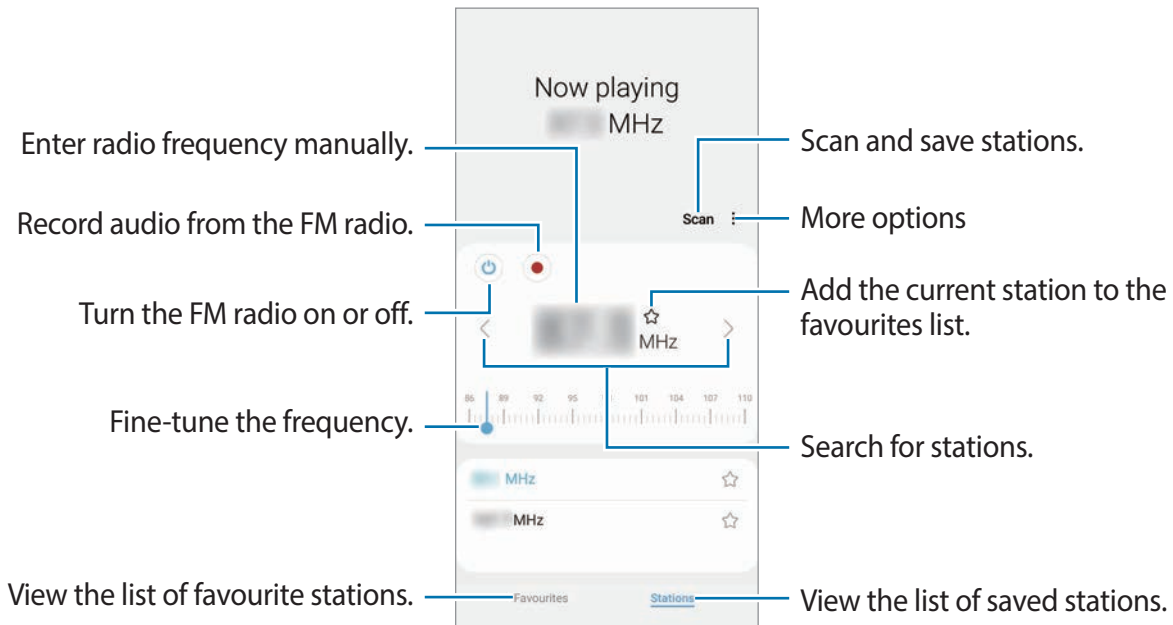

 This app may not be available depending on the service provider or model.



Playing through the speaker

You can listen to the radio through the speaker instead of the connected earphone.

Tap  → **Play through speaker**.

Voice Recorder

Record or play voice recordings.

- 1 Launch the **Voice Recorder** app.
- 2 Tap  to start recording. Speak into the microphone.
 - Tap  to pause recording.
 - While making a voice recording, tap **BOOKMARK** to insert a bookmark.
- 3 Tap  to finish recording.
- 4 Enter a file name and tap **Save**.

My Files

Access and manage various files stored in the device.

Launch the **My Files** app.

To check for unnecessary data and free up the device's storage, tap **Analyse storage**.

To search for files or folders, tap **Q**.

Clock





Set alarms, check the current time in many cities around the world, time an event, or set a specific duration.

Launch the **Clock** app.

Calculator

Perform simple or complex calculations.

Launch the **Calculator** app.

-  : View the calculation history. To clear the history, tap **Clear history**. To close the calculation history panel, tap .
-  : Use the unit conversion tool. You can convert various values, such as area, length, or temperature, into other units.
-  : Display the scientific calculator.

Game Launcher

Game Launcher gathers your games downloaded from **Play Store** and **Galaxy Store** into one place for easy access. You can set the device to game mode to play games more easily.

Launch the **Game Launcher** app and select the game you want.



- If **Game Launcher** does not appear, launch the **Settings** app, tap **Advanced features**, and then tap the **Game Launcher** switch to activate it.
- Games downloaded from **Play Store** and **Galaxy Store** will be automatically shown on the Game Launcher screen. If you cannot see your games, tap **My games** → ⋮ → **Add games**.

Removing a game from Game Launcher

Tap **My games**, tap and hold a game, and then tap **Remove**.

Changing the performance mode

You can change the game performance mode.

Launch the **Game Launcher** app, tap ≡ → **Game Booster** → **Game optimisation**, and then select the mode you want.

- **Performance:** This focuses on giving you the best possible performance while playing games.
- **Standard:** This balances the performance and the battery usage time.
- **Battery saver:** This saves battery power while playing games.











Battery power efficiency may vary by game.

Game Booster

Game Booster lets you play games in a better environment. You can use Game Booster while playing games.

To open the Game Booster panel while playing games, tap  on the navigation bar. If the navigation bar is hidden, drag upwards from the bottom of the screen to show it. If you have set the navigation bar to use **Swipe gestures**, open the notification panel and tap **Tap to open Game Booster**.

-  : Lock the touchscreen while the game is being played. To unlock the touchscreen, drag the lock icon in any direction.
 -  : Hide the buttons on the navigation bar. To display the buttons, tap  on the navigation bar.
 -  : Capture screenshots.
 -  : Record your game sessions. To stop recording, tap .
 -  : Configure settings for Game Booster.
 - **Priority mode**: Set the device to block incoming calls and all notifications except for alarms to prevent your game from being disturbed.
 - **Monitoring temperature / Monitoring memory**: Set the device to automatically adjust the volume or video frame rate to prevent the device from overheating and to stop apps from running in the background when there is not enough memory.
-  • You can set to open the Game Booster panel from the navigation bar while the navigation bar is set to **Swipe gestures**. On the Game Booster panel, tap  → **Block during game** and tap the **Navigation gestures** switch to activate it.
- Available options may vary depending on the game.

Launching apps in pop-up windows while playing games

You can launch apps in pop-up windows while playing a game.

Tap  and select an app from the apps list.

SmartThings

Control and manage smart appliances and Internet of Things (IoT) products with your smartphone.

To view more information, launch the **SmartThings** app and tap **Menu** → **How to use**.

1 Launch the **SmartThings** app.

2 Tap **Devices** → **Add device** or **+**.

3 Select a device and connect to it by following the on-screen instructions.



- Connection methods may vary depending on the type of connected devices or the shared content.
- The devices you can connect may vary depending on the region. Available features may differ depending on the connected device.
- Connected devices' own errors or defects are not covered by the Samsung warranty. When errors or defects occur on the connected devices, contact the device's manufacturer.

Sharing content

Share content by using various sharing options. The following actions are an example of sharing images.





- 1 Launch the **Gallery** app and select an image.
- 2 Tap  and select a sharing method you want.

 You may incur additional charges when sharing files via the mobile network.

Quick Share

Sharing content with nearby devices

Share content with nearby devices via Wi-Fi Direct or Bluetooth, or with SmartThings supported devices.

- 1 Launch the **Gallery** app and select an image.
- 2 On the other device, open the notification panel, swipe downwards, and then tap  (**Quick Share**) to activate it. If you cannot find  (**Quick Share**) on the quick panel, tap  and drag the button over to add it.
- 3 Tap  → **Quick Share** and select a device to transfer the image to.
- 4 Accept the file transfer request on the other device.

 This feature does not support sharing videos with TVs or SmartThings supported devices. To watch videos on TV, use the Smart View feature.

Setting who can find your device

Set who is allowed to find and send content to your device.

- 1 Open the notification panel, swipe downwards, and then tap  (**Quick Share**).
- 2 Select an option.
 - **No one:** Do not allow others to find your device.
 - **Contacts only:** Only allow Samsung users in your contacts to share with your device.
 - **Anyone nearby:** Allow any nearby devices to share with your device.

Sharing via Web link

Upload large files to the Samsung storage server and share them with others via Web link.

- 1 Launch the **Gallery** app and select an image.
- 2 Tap  → **Quick Share** and select an option you want under **Share as link**.
 - **Share using QR code:** The link to the server where the image was uploaded will be created as a QR code. Scan the QR code on the other device to share the link.
 - **Share in an app:** When you select an app, the link to the server where the image was uploaded will be displayed. Share the link with others.

Music Share

Introduction

The Music Share feature allows you to share your Bluetooth speaker that is already connected to your device with another person. You can also listen to the same music on your Galaxy Buds and another person's Galaxy Buds.

This feature is available only on devices that support the Music Share feature.

Sharing a Bluetooth speaker

You can listen to music on your smartphone and your friend's smartphone via your Bluetooth speaker.

- 1 Make sure that your smartphone and your Bluetooth speaker are connected.
Refer to [Pairing with other Bluetooth devices](#) for how to connect.
- 2 On your smartphone, launch the **Settings** app, tap **Connections** → **Bluetooth** →  → **Advanced**, and then tap the **Music Share** switch to activate it.
You can use additional features, such as setting who to share your device with, by tapping **Music Share**.
- 3 On your friend's smartphone, select your speaker from the list of the Bluetooth devices.
- 4 On your smartphone, accept the connection request.
Your speaker will be shared.
When you play music via your friend's smartphone, the music playing via your smartphone will be paused.

Listening to music together with Galaxy Buds

You can listen to music on your smartphone together through your Buds and your friend's Buds.

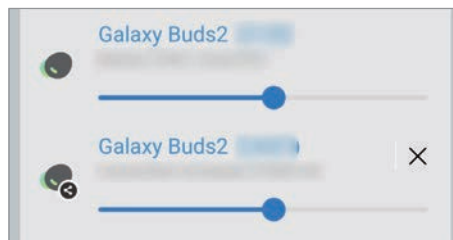

This feature is supported only on the Galaxy Buds series.

- 1 Make sure that each smartphone and pair of Buds are connected.
Refer to [Pairing with other Bluetooth devices](#) for how to connect.
- 2 On your friend's smartphone, launch the **Settings** app, tap **Connections** → **Bluetooth** → **⋮** → **Advanced**, and then tap the **Music Share** switch to activate it.
You can use additional features, such as setting who to share your device with, by tapping **Music Share**.
- 3 On your smartphone, open the notification panel and tap **Media output**.
- 4 Tap **Music Share** and select your friend's Buds from the detected devices list.
- 5 On your friend's smartphone, accept the connection request.
When you play music via your smartphone, you can listen to it together via both Buds.



Smart View

View your device's displayed content on a large screen by connecting your device to a screen mirroring-enabled TV or monitor.

- 1 Open the notification panel, swipe downwards, and then tap  (**Smart View**).
 - 2 Select a device to mirror your device's screen.
-  When you play a video with Smart View, the resolution may vary depending on the TV model.

Link to Windows (SM-M336B/DS, SM-M336BU/DS)

You can connect your device to a Windows PC to instantly access your device's data, such as pictures or messages, on the computer.

When calls or messages come in, you can receive them on the computer.

- It is recommended to use the latest version of Windows and the **Your Phone** app to fully use this feature.
- A Microsoft account is required to use this feature. When you create a Microsoft account, you can sign in to all Microsoft devices and services, such as Microsoft Office programs and Windows 10.

Connecting to a computer

- 1 Launch the **Settings** app and tap **Advanced features** → **Link to Windows**.
- 2 Follow the on-screen instructions to complete the connection.

Visit <https://aka.ms/setup1tw> for details.

Viewing data and notifications from your device on the computer

Launch the **Your Phone** app on the computer and select a category you want.

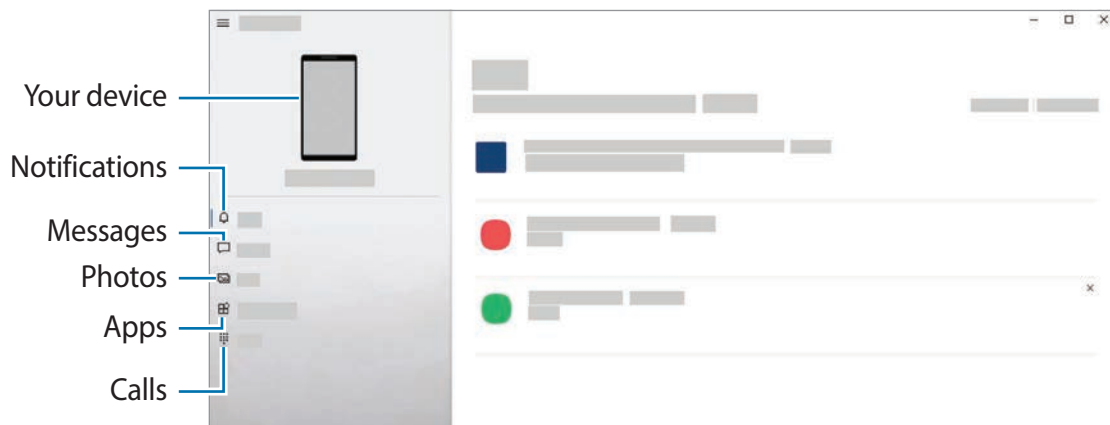

Available features and menus may vary depending on the software version or model.

Google apps

Google provides entertainment, social network, and business apps. You may require a Google account to access some apps.

To view more app information, access each app's help menu.

- **Chrome:** Search for information and browse webpages.
- **Gmail:** Send or receive emails via the Google Mail service.
- **Maps:** Find your location on the map, search the world map, and view location information for various places around you.
- **YT Music:** Enjoy various music and videos provided by YouTube Music. You can also view the music collections stored on your device and play them.
- **Google Play Movies & TV:** Purchase or rent videos, such as movies and TV programmes, from **Play Store**.
- **Drive:** Store your content on the cloud, access it from anywhere, and share it with others.
- **YouTube:** Watch or create videos and share them with others.
- **Photos:** Search for, manage, and edit all your pictures and videos from various sources in one place.
- **Google:** Search quickly for items on the Internet or your device.
- **Duo:** Make a simple video call.
- **Messages:** Send and receive messages on your device or computer, and share various content, such as images and videos.



Some apps may not be available depending on the service provider or model.

Settings

Introduction

Customise device settings.

Launch the **Settings** app.

To search for settings by entering keywords, tap **Q**. You can also search for settings by selecting a tag under **Suggestions**.

Samsung account

Sign in to your Samsung account and manage it.

On the Settings screen, tap **Samsung account**.

Connections

Options

Change settings for various connections, such as the Wi-Fi feature and Bluetooth.

On the Settings screen, tap **Connections**.

- **Wi-Fi:** Activate the Wi-Fi feature to connect to a Wi-Fi network and access the Internet or other network devices. Refer to [Wi-Fi](#) for more information.
- **Bluetooth:** Use Bluetooth to exchange data or media files with other Bluetooth-enabled devices. Refer to [Bluetooth](#) for more information.
- **NFC and contactless payments:** Set the device to allow you to read near field communication (NFC) tags that contain information about products. You can also use this feature to make payments and buy tickets for transportation or events after downloading the required apps. Refer to [NFC and contactless payments](#) for more information.

- **Flight mode:** Set the device to disable all wireless functions on your device. You can use only non-network services.



Follow the regulations provided by the airline and the instructions of aircraft personnel. In cases where it is allowed to use the device, always use it in flight mode.

- **Mobile networks:** Configure your mobile network settings.
- **Data usage:** Keep track of your data usage amount and customise the settings for the limitation. Set the device to automatically disable the mobile data connection when the amount of mobile data you have used reaches your specified limit.

You can activate the data saver feature to prevent some apps running in the background from sending or receiving data. Refer to [Data saver](#) for more information.

You can also select apps to always use the mobile data even when your device is connected to a Wi-Fi network. Refer to [Mobile data only apps](#) for more information.

- **SIM card manager:** Activate your SIM or USIM cards and customise the SIM card settings. Refer to [SIM card manager](#) for more information.
- **Mobile Hotspot and Tethering:** Use the device as a mobile hotspot to share the device's mobile data connection with other devices. For more information about the mobile hotspot, refer to [Mobile Hotspot](#).



You may incur additional charges when using this feature.

- **More connection settings:** Customise settings to control other features. Refer to [More connection settings](#) for more information.

Wi-Fi



Activate the Wi-Fi feature to connect to a Wi-Fi network and access the Internet or other network devices.

Connecting to a Wi-Fi network

1 On the Settings screen, tap **Connections** → **Wi-Fi** and tap the switch to activate it.

2 Select a network from the Wi-Fi networks list.

Networks with a lock icon require a password.

-  • Once the device connects to a Wi-Fi network, the device will reconnect to that network each time it is available without requiring a password. To prevent the device from connecting to the network automatically, tap  next to the network and tap the **Auto reconnect** switch to deactivate it.
- If you cannot connect to a Wi-Fi network properly, restart your device's Wi-Fi feature or the wireless router.

Viewing the Wi-Fi network quality information

View the Wi-Fi network quality information, such as the speed and stability.

On the Settings screen, tap **Connections** → **Wi-Fi** and tap the switch to activate it. The network quality information will appear under the Wi-Fi networks. If it does not appear, tap  → **Advanced** and tap the **Show network quality info** switch to activate it.

-  The quality information may not appear depending on the Wi-Fi network.

Sharing Wi-Fi network passwords

If you make a request to a person who is connected to a secured Wi-Fi network to share its password, you can connect to the network without entering the password. This feature is available between the devices which have contacts each other and the screen of the other device must be turned on.

1 On the Settings screen, tap **Connections** → **Wi-Fi** and tap the switch to activate it.

2 Select a network from the Wi-Fi networks list.

3 Tap **Request password**.

4 Accept the share request on the other device.

The Wi-Fi password is entered on your device and it is connected to the network.

Wi-Fi Direct

Wi-Fi Direct connects devices directly via a Wi-Fi network without requiring an access point.

- 1 On the Settings screen, tap **Connections** → **Wi-Fi** and tap the switch to activate it.
- 2 Tap  → **Wi-Fi Direct**.
The detected devices are listed.
If the device you want to connect to is not in the list, request that the device turns on its Wi-Fi Direct feature.
- 3 Select a device to connect to.
The devices will be connected when the other device accepts the Wi-Fi Direct connection request.
To end the device connection, select the device to disconnect from the list.

Bluetooth

Use Bluetooth to exchange data or media files with other Bluetooth-enabled devices.

Precautions for using Bluetooth

- Samsung is not responsible for the loss, interception, or misuse of data sent or received via Bluetooth.
- Always ensure that you share and receive data with devices that are trusted and properly secured. If there are obstacles between the devices, the operating distance may be reduced.
- Some devices, especially those that are not tested or approved by the Bluetooth SIG, may be incompatible with your device.
- Do not use the Bluetooth feature for illegal purposes (for example, pirating copies of files or illegally tapping communications for commercial purposes). Samsung is not responsible for the repercussion of illegal use of the Bluetooth feature.

Pairing with other Bluetooth devices

- 1 On the Settings screen, tap **Connections** → **Bluetooth** and tap the switch to activate it.
The detected devices will be listed.
- 2 Select a device to pair with.
If the device you want to pair with is not on the list, set the device to enter Bluetooth pairing mode. Refer to the other device's user manuals.

 Your device is visible to other devices while the Bluetooth settings screen is open.

- 3 Accept the Bluetooth connection request on your device to confirm.
The devices will be connected when the other device accepts the Bluetooth connection request.

To unpair the devices, tap  next to the device name to unpair and tap **Unpair**.

Sending and receiving data

Many apps support data transfer via Bluetooth. You can share data, such as contacts or media files, with other Bluetooth devices. The following actions are an example of sending an image to another device.

- 1 Launch the **Gallery** app and select an image.
- 2 Tap  → **Bluetooth** and select a device to transfer the image to.
If the device you want to pair with is not in the list, request that the device turns on its visibility option.
- 3 Accept the Bluetooth connection request on the other device.

NFC and contactless payments

Your device allows you to read near field communication (NFC) tags that contain information about products. You can also use this feature to make payments and buy tickets for transportation or events after downloading the required apps.

-  The device contains a built-in NFC antenna. Handle the device carefully to avoid damaging the NFC antenna.

Reading information from NFC tags

Use the NFC feature to read product information from NFC tags.

- 1 On the Settings screen, tap **Connections** and tap the **NFC and contactless payments** switch to activate it.

- 2 Place the NFC antenna area on the back of your device near an NFC tag.
The information from the tag appears.

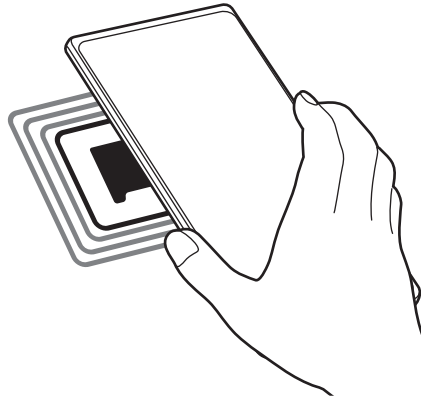

- ☑ Ensure that the device's screen is turned on and unlocked. Otherwise, the device will not read NFC tags or receive data.

Making payments with the NFC feature

Before you can use the NFC feature to make payments, you must register for the mobile payment service. To register or get more information about the service, contact your service provider.

- 1 On the Settings screen, tap **Connections** and tap the **NFC and contactless payments** switch to activate it.
- 2 Touch the NFC antenna area on the back of your device to the NFC card reader.

To set the default payment app, open the Settings screen and tap **Connections** → **NFC and contactless payments** → **Contactless payments** → **Payment**, and then select an app.

- ☑ • The payment services list may not include all available payment apps.
- If you update the payment app or install a new one, the payment services that you used before may not work properly. If that is the case, on the Settings screen, tap **Connections** → **NFC and contactless payments** → **Contactless payments** → **Payment** or **Others**, and then select another app instead of the updated or newly installed app. Or, deselect the selected app.

Data saver

Reduce your data usage by preventing some apps running in the background from sending or receiving data.

On the Settings screen, tap **Connections** → **Data usage** → **Data saver** and tap the switch to activate it.

When the data saver feature is activated, the  icon will appear on the status bar.

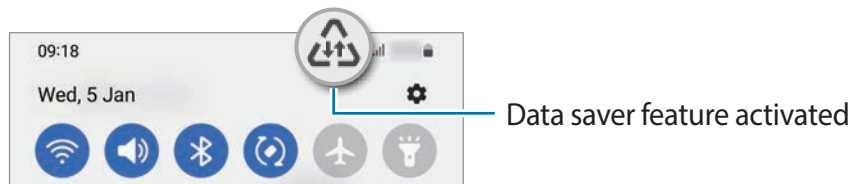

 To select apps to use data without restriction, tap **Allowed to use data while Data saver is on** and select apps.

Mobile data only apps

Select apps to always use the mobile data even when your device is connected to a Wi-Fi network.

For example, you can set the device to use only mobile data for apps that you want to keep secure or streaming apps that can be disconnected. Even if you do not deactivate the Wi-Fi feature, the apps will launch using the mobile data.

On the Settings screen, tap **Connections** → **Data usage** → **Mobile data only apps** and tap the switches next to the apps you want.

 You may incur additional charges when using this feature.

Mobile Hotspot

Use your device as a mobile hotspot to share your device's mobile data connection with other devices.

1 On the Settings screen, tap **Connections** → **Mobile Hotspot and Tethering** → **Mobile Hotspot**.

2 Tap the switch to activate it.

The  icon appears on the status bar.

You can change the level of security and the password by tapping **Configure**.

3 On the other device's screen, search for and select your device from the Wi-Fi networks list. Alternatively, tap **QR code** on the mobile hotspot screen and scan the QR code with the other device.

-  • If the mobile hotspot is not found, on your device, tap **Configure** and set **Band** to **2.4 GHz**, tap **Advanced**, and then tap the **Hidden network** switch to deactivate it.
- If you activate the **Auto Hotspot** feature, you can share your device's mobile data connection with other devices signed in to your Samsung account.

More connection settings

Customise settings to control other connection features.

On the Settings screen, tap **Connections** → **More connection settings**.

- **Nearby device scanning:** Set the device to scan for nearby devices to connect to.
- **Printing:** Configure settings for printer plug-ins installed on the device. You can search for available printers or add one manually to print files. Refer to [Printing](#) for more information.
- **VPN:** Set up virtual private networks (VPNs) on your device to connect to a school or company's private network.
- **Private DNS:** Set the device to use the security enhanced private DNS.
- **Ethernet:** When you connect an Ethernet adaptor, you can use a wired network and configure network settings.

Printing

Configure settings for printer plug-ins installed on the device. You can connect the device to a printer via Wi-Fi or Wi-Fi Direct, and print images or documents.



-  Some printers may not be compatible with the device.

Adding printer plug-ins

Add printer plug-ins for printers you want to connect the device to.

- 1 On the Settings screen, tap **Connections** → **More connection settings** → **Printing** → **Download plugin**.
- 2 Select a printer plug-in and install it.
- 3 Select the installed printer plug-in.
The device will automatically search for printers that are connected to the same Wi-Fi network as your device.

4 Select a printer to add.

 To add printers manually, tap  → **Add printer**.

Printing content

While viewing content, such as images or documents, access the options list, tap **Print** → **Select a printer** → **All printers...**, and then select a printer.

 Printing methods may vary depending on the content type.

Sounds and vibration

Options

Change settings for various sounds on the device.

On the Settings screen, tap **Sounds and vibration**.

- **Sound mode:** Set the device to use sound mode, vibration mode, or silent mode.
- **Vibrate while ringing:** Set the device to vibrate and play a ringtone for incoming calls.
- **Temporary mute:** Set the device to use silent mode for a certain period.
- **Ringtone:** Change the call ringtone.
- **Notification sound:** Change the notification sound.
- **System sound:** Change the sound to use for certain actions, such as charging the device.
- **Volume:** Adjust the device's volume level.
- **Call vibration pattern:** Change the call vibration pattern.
- **Notification vibration pattern:** Change the notification vibration pattern.
- **Vibration intensity:** Adjust the force of the vibration notification.
- **System sound/vibration control:** Set the device to sound or vibrate for actions, such as controlling the touchscreen.
- **Sound quality and effects:** Set the device's sound quality and effects. Refer to [Sound quality and effects](#) for more information.
- **Separate app sound:** Set the device to play media sound from a specific app separately on the other audio device. Refer to [Separate app sound](#) for more information.

 Some features may not be available depending on the model.

Sound quality and effects

Set the device's sound quality and effects.

On the Settings screen, tap **Sounds and vibration** → **Sound quality and effects**.

- **Dolby Atmos:** Select a surround sound mode optimised for various types of audio, such as movies, music, and voice. With Dolby Atmos, you can experience moving audio sounds that flow all around you.
- **Dolby Atmos for gaming:** Experience the Dolby Atmos sound optimised for games while playing games.
- **Equaliser:** Select an option for a specific music genre and enjoy optimised sound.
- **UHQ upscaler:** Enhance the sound resolution of music and videos when using wired earphones.
- **Adapt sound:** Set the best sound for you.



Depending on the model, you must connect an earphone to use some features.

Separate app sound

Set the device to play media sound from a specific app on the connected Bluetooth speaker or headset.

For example, you can listen to the Navigation app through your device's speaker while listening to playback from the Music app through the vehicle's Bluetooth speaker.

- 1 On the Settings screen, tap **Sounds and vibration** → **Separate app sound** and tap the switch to activate it.
- 2 Select an app to play media sounds separately and tap the Back button.
- 3 Select a device for playing the selected app's media sound.

Notifications

Change the notification settings.

On the Settings screen, tap **Notifications**.

- **Notification pop-up style:** Select a notification pop-up style and change the settings.
- **Recently sent:** View the apps that received recent notifications and change the notification settings. To customise notification settings for more apps, tap **More** → ▼ → **All** and select an app from the apps list.
- **Do not disturb:** Set the device to mute all sounds except for allowed exceptions.
- **Advanced settings:** Configure advanced settings for notifications.

Display

Options

Change the display and the Home screen settings.

On the Settings screen, tap **Display**.

- **Light / Dark:** Activate or deactivate dark mode.
- **Dark mode settings:** Reduce eye strain by applying the dark theme when using the device at night or in a dark place. You can set a schedule for applying dark mode.
 The dark theme may not be applied in some apps.
- **Brightness:** Adjust the brightness of the display.
- **Adaptive brightness:** Set the device to keep track of your brightness adjustments and apply them automatically in similar lighting conditions.
- **Motion smoothness:** Change the refresh rate of the screen. When a high refresh rate is set, the screen will scroll more smoothly. Refer to [Motion smoothness](#) for more information.
- **Eye comfort shield:** Reduce eye strain by limiting the amount of blue light emitted by the screen. You can set a schedule for applying this feature.
- **Font size and style:** Change the font size and style.
- **Screen zoom:** Make the items on the screen larger or smaller.
- **Full screen apps:** Select apps to use with the full screen aspect ratio.

- **Screen timeout:** Set the length of time the device waits before turning off the display's backlight.
- **Easy mode:** Switch to easy mode to display larger icons and apply a simpler layout to the Home screen.
- **Edge panels:** Change the settings for the Edge panel.
- **Navigation bar:** Change the navigation bar settings. Refer to [Navigation bar \(soft buttons\)](#) for more information.
- **Touch sensitivity:** Increase the touch sensitivity of the screen for use with screen protectors.
- **Screen saver:** Set the device to launch a screensaver when the device is charging.



Some features may not be available depending on the model.

Motion smoothness

The refresh rate is the number of times the screen is refreshed every second. Use a high refresh rate to prevent the screen from flickering when switching between screens. The screen will scroll more smoothly. When you select a standard refresh rate, you can use the battery longer.

- 1 On the Settings screen, tap **Display** → **Motion smoothness**.
- 2 Select a refresh rate.
 - **Adaptive:** Get smoother animations and scrolling by automatically adjusting your screen refresh rate up to 120 Hz.
 - **Standard:** Use a standard refresh rate in normal situations to conserve battery power.

Wallpaper and style

Change the wallpaper settings for the Home screen and the locked screen.

On the Settings screen, tap **Wallpaper and style**.

Themes

Apply various themes to the device to change the visual elements of the Home screen, locked screen, and icons.

On the Settings screen, tap **Themes**.

Home screen

Configure settings for the Home screen, such as the screen layout.

On the Settings screen, tap **Home screen**.

Lock screen

Options

Change the settings for the locked screen.

On the Settings screen, tap **Lock screen**.

- **Screen lock type:** Change the screen lock method.
 - **Smart Lock:** Set the device to unlock itself when trusted locations or devices are detected. Refer to [Smart Lock](#) for more information.
 - **Secure lock settings:** Change screen lock settings for the selected lock method.
 - **Wallpaper services:** Set the device to use wallpaper services such as Dynamic Lock screen.
 - **Clock style:** Change the type and colour of the clock on the locked screen.
 - **Roaming clock:** Change the clock to show both the local and home time zones on the locked screen when roaming.
 - **Widgets:** Change the settings of the items displayed on the locked screen.
 - **Contact information:** Set the device to show contact information, such as your email address, on the locked screen.
 - **Notifications:** Set how to show notifications on the locked screen.
 - **Shortcuts:** Select apps to display shortcuts to them on the locked screen.
 - **About Lock screen:** View the Lock screen version and legal information.
-  • Some features may not be available depending on the service provider or model.
- The available options may vary depending on the screen lock method selected.

Smart Lock

You can set the device to unlock itself and remain unlocked when trusted locations or devices are detected.

For example, if you have set your home as a trusted location, when you get home your device will detect the location and automatically unlock itself.

On the Settings screen, tap **Lock screen** → **Smart Lock** and follow the on-screen instructions to complete the setup.



- This feature will be available to use after you set a screen lock method.
- If you do not use your device for four hours or when you turn on the device, you must unlock the screen using the pattern, PIN, or password you set.

Biometrics and security

Options

Change the settings for securing the device.

On the Settings screen, tap **Biometrics and security**.

- **Face recognition:** Set the device to unlock the screen by recognising your face. Refer to [Face recognition](#) for more information.
- **Fingerprints:** Register your fingerprints to unlock the screen. Refer to [Fingerprint recognition](#) for more information.
- **More biometrics settings:** Change the settings for biometric data. You can also view the version of the biometrics security patch and check for updates.
- **Google Play Protect:** Set the device to check for harmful apps and behaviour and warn about potential harm and remove them.
- **Security update:** View the version of your device's software and check for updates.
- **Find My Mobile:** Activate or deactivate the Find My Mobile feature. Access the Find My Mobile website (findmymobile.samsung.com) to track and control your lost or stolen device.
- **Samsung Pass:** Verify your identity easily and securely via your biometric data. Refer to [Samsung Pass](#) for more information.
- **Secure Folder:** Create a secure folder to protect your private content and apps from others. Refer to [Secure Folder](#) for more information.

- **Secure Wi-Fi:** Set the device to protect your data while using unsecured Wi-Fi networks. Refer to [Secure Wi-Fi](#) for more information.
- **Private Share:** Share files with others securely using blockchain technology.
- **Install unknown apps:** Set the device to allow the installation of apps from unknown sources.
- **Encrypt SD card:** Set the device to encrypt files on a memory card.
 - ❗ If you reset your device to the factory defaults with this setting enabled, the device will not be able to read your encrypted files. Disable this setting before resetting the device.
- **Other security settings:** Configure additional security settings.



Some features may not be available depending on the service provider or model.

Face recognition

You can set the device to unlock the screen by recognising your face.



- If you use your face as a screen lock method, your face cannot be used to unlock the screen for the first time after turning on the device. To use the device, you must unlock the screen using the pattern, PIN, or password you set when registering the face. Be careful not to forget your pattern, PIN, or password.
- If you change the screen lock method to **Swipe** or **None**, which are not secure, all of your biometric data will be deleted.

❗ Precautions for using face recognition

Before using the face recognition to unlock your device, keep the following precautions in mind.

- Your device could be unlocked by someone or something that looks like your image.
- Face recognition is less secure than Pattern, PIN, or Password.

For better face recognition

Consider the following when using face recognition:

- Consider the conditions when registering, such as wearing glasses, hats, masks, beards, or heavy makeup
- Ensure that you are in a well-lit area and that the camera lens is clean when registering
- Ensure your image is not blurry for better match results

Registering your face

For better face registration, register your face indoors and out of direct sunlight.

- 1 On the Settings screen, tap **Biometrics and security** → **Face recognition**.
- 2 Read the on-screen instructions and tap **Continue**.
- 3 Set a screen lock method.
- 4 Position your face inside the frame on the screen.

The camera will scan your face.

-  • If unlocking the screen with your face is not working properly, tap **Remove face data** to remove your registered face and register your face again.
- To enhance the face recognition, tap **Add alternative appearance to enhance recognition** and add an alternate appearance.

Unlocking the screen with your face

You can unlock the screen with your face instead of using a pattern, PIN, or password.

- 1 On the Settings screen, tap **Biometrics and security** → **Face recognition**.
- 2 Unlock the screen using the preset screen lock method.
- 3 Tap the **Face unlock** switch to activate it.
- 4 On the locked screen, look at the screen.

When your face is recognised, you can unlock the screen without using any additional screen lock method. If your face is not recognised, use the preset screen lock method.

Deleting the registered face data

You can delete face data that you have registered.

- 1 On the Settings screen, tap **Biometrics and security** → **Face recognition**.
- 2 Unlock the screen using the preset screen lock method.
- 3 Tap **Remove face data** → **Remove**.

Once the registered face is deleted, all the related features will also be deactivated.

Fingerprint recognition

In order for fingerprint recognition to function, your fingerprint information needs to be registered and stored in your device.



- This feature may not be available depending on the service provider or model.
- Fingerprint recognition uses the unique characteristics of each fingerprint to enhance the security of your device. The likelihood of the fingerprint sensor confusing two different fingerprints is very low. However, in rare cases where separate fingerprints are very similar the sensor may recognise them as identical.
- If you use your fingerprint as a screen lock method, your fingerprint cannot be used to unlock the screen for the first time after turning on the device. To use the device, you must unlock the screen using the pattern, PIN, or password you set when registering the fingerprint. Be careful not to forget your pattern, PIN, or password.
- If your fingerprint is not recognised, unlock the device using the pattern, PIN, or password you set when registering the fingerprint, and then re-register your fingerprints. If your pattern, PIN, or password is forgotten, you will not be able to use the device if you do not reset it. Samsung is not responsible for any data loss or inconvenience caused by forgotten unlock codes.
- If you change the screen lock method to **Swipe** or **None**, which are not secure, all of your biometric data will be deleted.

For better fingerprint recognition

When you scan your fingerprints on the device, be aware of the following conditions that may affect the feature's performance:

- The device may not recognise fingerprints that are affected by wrinkles or scars.
- The device may not recognise fingerprints from small or thin fingers.
- To improve recognition performance, register the fingerprints of the fingers used most often to perform tasks on the device.
- The Side key has a built-in fingerprint recognition sensor. Ensure that the fingerprint recognition sensor is not scratched or damaged by metal objects, such as coins, keys, and necklaces.
- Covering the fingerprint recognition sensor with accessories, such as stickers, may decrease the fingerprint recognition rate.
- Ensure that the fingerprint recognition sensor and your fingers are clean and dry.

- If you bend your finger or use a fingertip, the device may not recognise your fingerprints. Make sure to cover the entire fingerprint recognition sensor with your finger.
- In dry environments, static electricity can build up in the device. Avoid using this feature in dry environments or before using the feature, discharge static electricity by touching a metal object.

Registering fingerprints

- 1 On the Settings screen, tap **Biometrics and security** → **Fingerprints**.
- 2 Read the on-screen instructions and tap **Continue**.
- 3 Set a screen lock method.
- 4 Place your finger on the Side key. After the device detects your finger, lift it up and place it on the Side key again.
Repeat this action until the fingerprint is registered.

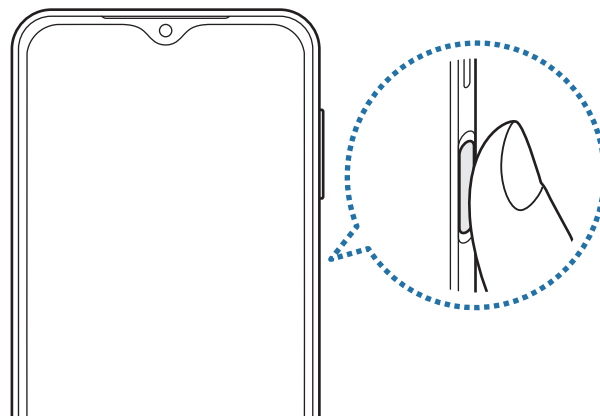

- 5 When you are finished registering your fingerprints, tap **Done**.
You can check whether your fingerprint is registered by tapping **Check added fingerprints**.

Unlocking the screen with your fingerprints

You can unlock the screen with your fingerprint instead of using a pattern, PIN, or password.

- 1 On the Settings screen, tap **Biometrics and security** → **Fingerprints**.
- 2 Unlock the screen using the preset screen lock method.
- 3 Tap the **Fingerprint unlock** switch to activate it.
- 4 On the locked screen, place your finger on the fingerprint recognition sensor and scan your fingerprint.

Deleting registered fingerprints

You can delete registered fingerprints.

- 1 On the Settings screen, tap **Biometrics and security** → **Fingerprints**.
- 2 Unlock the screen using the preset screen lock method.
- 3 Select a fingerprint to delete and tap **Remove**.

Samsung Pass

Register your biometric data to Samsung Pass and easily verify your identity when using services which require your login or personal information.



- The website sign-in feature is only available for websites that you access via the **Internet** app. Some websites may not support this feature.
- Registered biometric data is only saved to your device and is not synced with other devices or servers.

Registering Samsung Pass

Before using Samsung Pass, register your biometric data to Samsung Pass.

On the Settings screen, tap **Biometrics and security** → **Samsung Pass**. Follow the on-screen instructions to complete the setup.

Verifying the Samsung account password

You can use your registered biometric data to verify your identity instead of entering your Samsung account password when, for example, you purchase content from **Galaxy Store**.

On the Samsung Pass main screen, tap **⋮** → **Settings** → **Account and syncing**, and then tap the **Verify with Samsung Pass** switch to activate it.

Using Samsung Pass to sign in to websites

You can use Samsung Pass to easily sign in to websites that support ID and password autofill.

- 1 On the sign-in page of the website, enter your ID and password, and then tap the website's sign-in button.
- 2 When a pop-up window asking whether you want to save the sign-in information appears, tick **Sign in with Samsung Pass** and tap **Remember**.

Using Samsung Pass to sign in to apps

You can use Samsung Pass to easily sign in to apps that support ID and password autofill.

- 1 On the sign-in page of the app, enter your ID and password, and then tap the app's sign-in button.
- 2 When a pop-up window asking whether you want to save the sign-in information appears, tap **Save**.

Managing sign-in information

View the list of websites and apps you have set to use Samsung Pass and manage your sign-in information.

- 1 On the Samsung Pass main screen, tap **Apps** or **Websites** and select a website or app from the list.
- 2 Tap **Edit** and modify your ID, password, and the website's or app's name.
To delete your sign-in information, tap **Delete**.

Using Samsung Pass with websites and apps

When using websites or apps that support Samsung Pass, you can easily sign in with Samsung Pass.

To see the list of websites and apps that support Samsung Pass, on the Samsung Pass main screen, tap  → **Settings** → **Partners**. If there are no websites or apps that support Samsung Pass, **Partners** will not appear.

-  Available websites and apps may vary depending on the service provider or model.
- Samsung is not responsible for any loss or inconvenience caused by signing in to websites or apps via Samsung Pass.

Entering your personal information automatically

You can use Samsung Pass to easily enter your personal information, such as your address or payment card information, on apps that support autofill.

- 1 On the Samsung Pass main screen, select an option under **Private info**.
- 2 Enter the information and tap **Save**.
You can now use the biometric data you registered to Samsung Pass when entering the personal information automatically on supported apps.

Deleting your Samsung Pass data

You can delete your biometric data, sign-in information, and app data registered to Samsung Pass.

On the Samsung Pass main screen, tap  → **Settings** → **See all devices using Samsung Pass** →  → **Leave Samsung Pass**.



- Your Samsung account will remain active.
- The Samsung Pass data on other devices signed in to your Samsung account will also be deleted.

Secure Folder

Secure Folder protects your private content and apps, such as pictures and contacts, from being accessed by others. You can keep your private content and apps secure even when the device is unlocked.



- Secure Folder is a separate, secured storage area. The data in Secure Folder cannot be transferred to other devices via unapproved sharing methods, such as USB or Wi-Fi Direct. Attempting to customise the operating system or modifying software will cause Secure Folder to be automatically locked and inaccessible. Before saving data in Secure Folder, make sure to back up a copy of the data in another secure location.

Setting up Secure Folder

- 1 Launch the **Settings** app and tap **Biometrics and security** → **Secure Folder**.
- 2 Follow the on-screen instructions to complete the setup.

The Secure Folder screen will appear and the Secure Folder app icon () will be added to the Apps screen.

To change the name or icon of Secure Folder, tap  → **Customise**.



- When you launch the **Secure Folder** app, you must unlock the app using your preset lock method.
- If you forget your Secure Folder unlock code, you can reset it using your Samsung account. Tap the button at the bottom of the locked screen, and enter your Samsung account password.

Setting an auto lock condition for Secure Folder

- 1 Launch the **Secure Folder** app and tap  → **Settings** → **Auto lock Secure Folder**.
- 2 Select a lock option.

 To manually lock your Secure Folder, tap  → **Lock and exit**.

Moving content to Secure Folder

Move content, such as pictures and videos, to Secure Folder. The following actions are an example of moving an image from the default storage to Secure Folder.

- 1 Launch the **Secure Folder** app and tap  → **Add files**.
- 2 Tap **Images**, tick images to move, and then tap **Done**.
- 3 Tap **Move**.
The selected items will be deleted from the original folder and moved to Secure Folder. To copy items, tap **Copy**.

 The method for moving content may vary depending on the content type.

Moving content from Secure Folder

Move content from Secure Folder to the corresponding app in the default storage. The following actions are an example of moving an image from Secure Folder to the default storage.

- 1 Launch the **Secure Folder** app and tap **Gallery**.
- 2 Select an image and tap  → **Move out of Secure Folder**.
The selected items will be moved to **Gallery** in the default storage.

Adding apps

Add an app to use in Secure Folder.

- 1 Launch the **Secure Folder** app and tap **+**.
- 2 Tick one or more apps installed on the device and tap **Add**.

Removing apps from Secure Folder

Tap and hold an app to delete, and tap **Uninstall**.

Adding accounts



Add your Samsung and Google accounts, or other accounts, to sync with the apps in Secure Folder.

- 1 Launch the **Secure Folder** app and tap  → **Settings** → **Manage accounts** → **Add account**.
- 2 Select an account service.
- 3 Follow the on-screen instructions to complete the account setup.

Hiding Secure Folder

You can hide the Secure Folder shortcut from the Apps screen.

Launch the **Secure Folder** app, tap  → **Settings**, and then tap the **Add Secure Folder to Apps screen** switch to deactivate it.

Alternatively, open the notification panel, swipe downwards, and then tap  (**Secure Folder**) to deactivate the feature. If you cannot find  (**Secure Folder**) on the quick panel, tap  and drag the button over to add it.

If you want to show the Secure Folder again, launch the **Settings** app, tap **Biometrics and security** → **Secure Folder**, and then tap the **Add Secure Folder to Apps screen** switch to activate it.

Uninstalling Secure Folder

You can uninstall Secure Folder, including the content and apps in it.

Launch the **Secure Folder** app and tap  → **Settings** → **More settings** → **Uninstall**.

To back up content before uninstalling Secure Folder, tick **Move media files out of Secure Folder** and tap **Uninstall**. To access data backed up from Secure Folder, launch the **My Files** app and tap **Internal storage** → **Download** → **Secure Folder**.

 Notes saved in **Samsung Notes** will not be backed up.

Secure Wi-Fi

Secure Wi-Fi is a service that secures your Wi-Fi network connection. It encrypts data using Wi-Fi networks and disables tracking apps and websites so that you can use Wi-Fi networks safely. For example, when using an unsecure Wi-Fi network in public places, such as cafes or airports, Secure Wi-Fi is automatically activated so that no one can hack your login information or monitor your activity in apps and websites.

On the Settings screen, tap **Biometrics and security** → **Secure Wi-Fi** and follow the on-screen instructions to complete the setup.

When Secure Wi-Fi is activated, the  icon will appear on the status bar.

-  • Using this feature may result in a slower Wi-Fi network speed.
- This feature may not be available depending on the Wi-Fi network, service provider, or model.

Selecting apps to protect using Secure Wi-Fi

Select apps to protect using Secure Wi-Fi so that you can safely protect data, such as your password or your activity in apps, from being accessed by others.

On the Settings screen, tap **Biometrics and security** → **Secure Wi-Fi** →  → **Settings** → **Protected apps** and tap the switches next to the apps you want to protect using Secure Wi-Fi.

-  Some apps may not support this feature.

Purchasing protection plan

You are provided with a free protection plan for Wi-Fi networks every month. You can also purchase paid protection plans and have unlimited bandwidth protection for a limited time.

1 On the Settings screen, tap **Biometrics and security** → **Secure Wi-Fi**.

2 Tap **Protection plan** → **Upgrade** and select the plan you want.

-  For certain protection plans, you can transfer the protection plan to another device signed in to your Samsung account.

3 Follow the on-screen instructions to complete the purchase.

Privacy

Change the settings for privacy.

On the Settings screen, tap **Privacy**.

- **Permissions used in last 24 hours:** View the app or feature's permission usage history.
- **Permission manager:** View the list of features and apps that have permission to use them. You can also edit the permission settings.
- **Controls and alerts:** Configure settings for app access.
- **Samsung:** Manage personal data related to your Samsung account and change the settings for Customisation Service.
- **Google:** Configure advanced settings for privacy.



Some features may not be available depending on the service provider or model.

Location

Change settings for location information permissions.

On the Settings screen, tap **Location**.

- **App permissions:** View the list of apps that have permission to access the device's location and edit the permission settings.
- **Location services:** View the location services your device is using.
- **Recent access:** View which apps request your current location information.

Safety and emergency

Manage your medical information and emergency contacts. You can also change settings for emergency features, such as wireless emergency alerts.

On the Settings screen, tap **Safety and emergency**.

- **Medical info:** Enter your medical information.
- **Emergency contacts:** Enter your emergency contacts.
- **Send SOS messages:** Set the device to send help messages by pressing the Side key several times.
- **Wireless emergency alerts:** Change the settings for wireless emergency alerts.
- **Emergency Location Service:** Activate the Emergency Location Service (ELS) feature.
- **Emergency mode:** Switch the device to emergency mode to reduce battery consumption. Refer to [Emergency mode](#) for more information.



Some features may not be available depending on the model.

Accounts and backup

Options

Sync, back up, or restore your device's data using Samsung Cloud. You can also sign in to accounts, such as your Samsung account or Google account, or transfer data to or from other devices via Smart Switch.

On the Settings screen, tap **Accounts and backup**.

- **Manage accounts:** Add your Samsung and Google accounts, or other accounts, to sync with.
- **Samsung Cloud:** Back up your data and settings, and restore the previous device's data and settings even when you do not have it. Refer to [Samsung Cloud](#) for more information.
- **Google Drive:** Keep your personal information, app data, and settings safe on your device. You can back up your sensitive information. You must sign in to your Google account to back up data.

- **Smart Switch:** Launch Smart Switch and transfer data from your previous device. Refer to [Transferring data from your previous device \(Smart Switch\)](#) for more information.



Regularly back up your data to a safe location, such as Samsung Cloud or a computer, so that you can restore it if the data is corrupted or lost due to an unintended factory data reset.

Samsung Cloud

Back up your device's data to Samsung Cloud and restore it later.

Backing up data

You can back up your device's data to Samsung Cloud.

- 1 On the Settings screen, tap **Accounts and backup** and tap **Back up data** under **Samsung Cloud**.
- 2 Tap the switches next to the items you want to back up and tap **Back up now**.
- 3 Tap **Done**.



- Some data will not be backed up. To check which data will be backed up, on the Settings screen, tap **Accounts and backup** and tap **Back up data** under **Samsung Cloud**.
- To view the backup data for other devices in your Samsung Cloud, on the Settings screen, tap **Accounts and backup** → **Restore data**, and then select a device you want.

Restoring data

You can restore your backup data from Samsung Cloud to your device.

- 1 On the Settings screen, tap **Accounts and backup**.
- 2 Tap **Restore data** and select a device you want.
- 3 Tick items you want to restore and tap **Restore**.

Google

Configure settings for some features provided by Google.

On the Settings screen, tap **Google**.

Advanced features

Options

Activate advanced features and change the settings that control them.

On the Settings screen, tap **Advanced features**.

- **Link to Windows:** Instantly access data saved in your device on your computer. Refer to [Link to Windows \(SM-M336B/DS, SM-M336BU/DS\)](#) for more information.
 - **Call & text on other devices:** Use your device's calling and messaging features on other devices signed in to your Samsung account.
 - **Continue apps on other devices:** Use your device's apps on other devices signed in to your Samsung account.
 - **Android Auto:** Connect your device to a vehicle and control some of your device's features on the vehicle's display.
 - **Quick Share:** Change the Quick Share settings. Refer to [Quick Share](#) for more information.
 - **Labs:** Use new features of the device.
 - **Side key:** Select an app or feature to launch using the Side key. Refer to [Setting the Side key](#) for more information.
 - **Motions and gestures:** Activate the motion feature and configure settings. Refer to [Motions and gestures](#) for more information.
 - **One-handed mode:** Activate one-handed operation mode for your convenience when using the device with one hand.
 - **Screenshots and screen recorder:** Change the settings for screenshots and screen recorder.
 - **Show contacts when sharing content:** Set the device to display the people you contacted on the sharing options panel to allow you to share content directly.
 - **Video call effects:** Set to use the feature that changes the background or block background noise during video calls. Refer to [Video call effects](#) for more information.
-  • This feature is only available in some apps.
- Some features may not be available depending on the model.

- **Game Launcher:** Activate the Game Launcher. Refer to [Game Launcher](#) for more information.
- **Dual Messenger:** Install the second app and use two separate accounts for the same messenger app. Refer to [Dual Messenger](#) for more information.

 Some features may not be available depending on the service provider or model.

Motions and gestures

Activate the motion feature and configure settings.

On the Settings screen, tap **Advanced features** → **Motions and gestures**.

- **Lift to wake:** Set the device to turn on the screen when you pick it up.
- **Double tap to turn on screen:** Set the device to turn on the screen by double-tapping anywhere on the screen while the screen is turned off.
- **Double tap to turn off screen:** Set the device to turn off the screen by double-tapping an empty area on the Home screen or the locked screen.
- **Keep screen on while viewing:** Set the device to prevent the display from turning off while you are looking at it.
- **Alert when phone picked up:** Set the device to alert you if you have missed calls or new messages when you pick up the device.

 This feature may not work if the screen is turned on or the device is not on a flat surface.

- **Turn over to mute:** Set the device to mute certain sounds by using motions or gestures.
- **Finger sensor gestures:** Set the device to open or close the notification panel when you swipe upwards or downwards on the fingerprint recognition sensor. This feature is not available when the sensor is detecting your fingerprint.

 Excessive shaking or an impact to the device may cause an unintended input for some features using sensors.

Video call effects

You can use features that change the background or block background noise during video calls.

On the Settings screen, tap **Advanced features** → **Video call effects** and tap the switch to activate it. The  icon will be added on the video calling app's screen.

Using video call effects

On the video calling app's screen, tap .

- **Reset all:** Reset the settings.
- **Background:** Change or blur the background during video calls.
- **Mic mode:** Block background noise to make the sound clearer.
 - **Standard:** Remove noise so that it sounds like a normal voice call.
 - **Voice focus:** Focus on the sound coming from the direction of the front camera.
 - **All sound:** Transmit all the sounds around you, such as the sound of music.
- **Settings:** Select or add background colours or images to use during video calls.



- Some features may not be available depending on the model.
- Some features are available only when using the front camera.

Dual Messenger

Install the second app and use two separate accounts for the same messenger app.

1 On the Settings screen, tap **Advanced features** → **Dual Messenger**.

Supported apps will appear.

2 Tap the switch of an app to install the second app.

The second app will be installed. The second app's icon will be displayed with .



- The Dual Messenger feature may not be available depending on the app.
- Some features of the app may be limited for the second app.

Uninstalling a second app

- 1 On the Settings screen, tap **Advanced features** → **Dual Messenger**.
- 2 Tap the switch of the app you want to uninstall and tap **Uninstall**.
All data related to the second app will be deleted.

 If you uninstall the first app, the second app will also be deleted.

Digital Wellbeing and parental controls

View the history of your device usage and use features to prevent your device from interfering with your life. You can also set up parental controls for your children and manage their digital use.

On the Settings screen, tap **Digital Wellbeing and parental controls**.

- **Screen time:** Set goals for how much you use your device a day.
- **App timers:** Limit the daily usage time for each app by setting a timer. When you reach the limit, the app will be deactivated and you cannot use it.
- **Focus mode:** Activate focus mode to avoid distractions from your device and stay focused on what you want. You can use the apps you allowed to be used in focus mode.
- **Bedtime mode:** Activate bedtime mode to reduce eye strain before sleeping and prevent your sleep from being disturbed.
- **Volume monitor:** Activate the volume monitor to protect your hearing. (SM-M336B/DS, SM-M336BU/DS)
- **Driving monitor:** Activate the driving monitor to monitor the amount of the time you use your device while driving.
- **Parental controls:** Manage your children's digital use.

Battery and device care

Introduction

The device care feature provides an overview of the status of your device's battery, storage, memory, and system security. You can also automatically optimise the device with a tap of your finger.

Optimising your device

On the Settings screen, tap **Battery and device care** → **Optimise now**.

The quick optimisation feature improves device performance through the following actions.

- Closing apps running in the background.
- Managing abnormal battery usage.
- Scanning for crashed apps and malware.

Using the auto optimisation feature

You can set the device to perform auto optimisation when your device is not in use. Tap  → **Automation** → **Auto optimise daily** and tap the switch to activate it. If you want to set the time to perform auto optimisation, tap **Time**.

Battery

Check the remaining battery power and time to use the device. For devices with low battery levels, conserve battery power by activating power saving features.

On the Settings screen, tap **Battery and device care** → **Battery**.

- **Power saving:** Activate power saving mode to extend the battery's usage time.
- **Background usage limits:** Limit battery usage for apps that you do not use often.
- **More battery settings:** Configure advanced settings for the battery.



- The usage time left shows the time remaining before the battery power runs out. Usage time left may vary depending on your device settings and operating conditions.
- You may not receive notifications from some apps that use power saving mode.

Storage

Check the status of the used and available memory.

On the Settings screen, tap **Battery and device care** → **Storage**. To delete files or uninstall apps that you do not use anymore, select a category. Then, tap and hold, or select, an item and tap **Delete** or **Uninstall**.

-  • The actual available capacity of the internal memory is less than the specified capacity because the operating system and default apps occupy part of the memory. The available capacity may change when you update the device.
- You can view the available capacity of the internal memory in the Specification section for your device on the Samsung website.

Memory

On the Settings screen, tap **Battery and device care** → **Memory**.

To speed up your device by stopping apps running in the background, tick apps from the apps list, and tap **Clean now**.

Device protection

Check the device's security status. This feature scans your device for malware.

On the Settings screen, tap **Battery and device care** → **Device protection** → **Scan phone**.

Ultra data saving

Monitor and reduce your mobile data usage by preventing background apps from using the mobile data connection. You can also use the data compression feature to compress Internet data, such as images, videos, and webpages, accessed via the mobile network.

On the Settings screen, tap **Battery and device care** → **Ultra data saving**, and then tap the switch to activate it.

-  • This feature may not be available depending on the service provider or model.
- Some webpages or content may not be available when this feature is activated, depending on the service provider or the mobile network conditions.

Software update

Update your device's software via the firmware over-the-air (FOTA) service. You can also schedule software updates.

On the Settings screen, tap **Battery and device care** → **Software update**.

Diagnostics

Test your device using Samsung Members.

On the Settings screen, tap **Battery and device care** → **Diagnostics**. Select an item to test or tap **Test all** to test all items.

Apps

Manage the device's apps and change their settings. You can view the apps' usage information, change their notification or permission settings, or uninstall or disable unnecessary apps.

On the Settings screen, tap **Apps**.

General management

Customise your device's system settings or reset the device.

On the Settings screen, tap **General management**.

- **Language:** Select device languages. Refer to [Adding device languages](#) for more information.
- **Text-to-speech output:** Change the settings for text-to-speech features used when TalkBack is activated, such as languages, speed, and more.
- **Date and time:** Access and alter the settings to control how the device displays the time and date.
 -  If the battery remains fully discharged, the time and date is reset.
- **Samsung Keyboard settings:** Change the settings for the Samsung keyboard.
- **Keyboard list and default:** Select a keyboard to use by default and change the keyboard settings.

- **Physical keyboard:** Change the settings for an external keyboard.
- **Mouse and trackpad:** Change the settings for an external mouse or trackpad.
- **Passwords and autofill:** Select an autofill service to use.
- **Reset:** Reset your device's settings or perform a factory data reset.
- **Contact us:** Ask questions or view frequently asked questions.

Adding device languages

You can add languages to use on your device.

1 On the Settings screen, tap **General management** → **Language** → **Add language**.

To view all the languages that can be added, tap  → **All languages**.

2 Select a language to add.

3 To set the selected language as the default language, tap **Set as default**. To keep the current language setting, tap **Keep current**.

The selected language will be added to your languages list. If you changed the default language, the selected language will be added to the top of the list.

To change the default language from your languages list, select the language you want and tap **Apply**. If an app does not support the default language, the next supported language in the list will be used.

Accessibility

Configure various settings to improve accessibility to the device.

On the Settings screen, tap **Accessibility**.

- **Recommended for you:** Check the accessibility features you are currently using and see other recommended features.
- **TalkBack:** Activate TalkBack, which provides voice feedback. To view help information to learn how to use this feature, tap **Settings** → **Tutorial and help**.
- **Visibility enhancements:** Customise the settings to improve accessibility for visually impaired users.
- **Hearing enhancements:** Customise the settings to improve accessibility for users with hearing impairment.
- **Interaction and dexterity:** Customise the settings to improve accessibility for users who have reduced dexterity.
- **Advanced settings:** Configure settings for Direct access and notification features.
- **Installed apps:** View accessibility services installed on the device.
- **About Accessibility:** View the Accessibility information.
- **Contact us:** Ask questions or view frequently asked questions.

Software update

Update your device's software via the firmware over-the-air (FOTA) service. You can also schedule software updates.

On the Settings screen, tap **Software update**.

- **Download and install:** Check for and install updates manually.
- **Auto download over Wi-Fi:** Set the device to download updates automatically when connected to a Wi-Fi network.
- **Last update:** View information about the last software update.



If emergency software updates are released for your device's security and to block new types of security threats, they will be installed automatically without your agreement.

Security updates information

Security updates are provided to strengthen the security of your device and protect your personal information. For security updates for your model, visit security.samsungmobile.com.

 The website supports only some languages.

Remote support

If you have any questions or technical problems with your device, you can get help through the remote support service.

On the Settings screen, tap **Remote support**.

About phone

Access your device's information.

On the Settings screen, tap **About phone**.

To change your device's name, tap **Edit**.

- **Status information:** View various device information, such as the SIM card status, Wi-Fi MAC address, and serial number.
- **Legal information:** View legal information related to the device, such as safety information and the open source licence.
- **Software information:** View the device's software information, such as its operating system version and firmware version.
- **Battery information:** View the device's battery status and information.

Usage notices

Precautions for using the device

Please read this manual when using the device to ensure safe and proper use.

- Descriptions are based on the device's default settings.
- Some content may differ from your device depending on the region, service provider, model specifications, or device's software.
- The device may require a connection to a Wi-Fi or mobile network when using some apps or features.
- Content (high quality content) that requires high CPU and RAM usage will affect the overall performance of the device. Apps related to the content may not work properly depending on the device's specifications and the environment that it is used in.
- Samsung is not liable for performance issues caused by apps supplied by providers other than Samsung.
- Samsung is not liable for performance issues or incompatibilities caused by edited registry settings or modified operating system software. Attempting to customise the operating system may cause the device or apps to work improperly.
- Software, sound sources, wallpapers, images, and other media provided with this device are licensed for limited use. Extracting and using these materials for commercial or other purposes is an infringement of copyright laws. Users are entirely responsible for illegal use of media.
- You may incur additional charges for data services, such as messaging, uploading and downloading, auto-syncing, or using location services depending on your data plan. For large data transfers, it is recommended to use the Wi-Fi feature.
- Default apps that come with the device are subject to updates and may no longer be supported without prior notice.
- Modifying the device's operating system or installing software from unofficial sources may result in device malfunctions and data corruption or loss. These actions are violations of your Samsung licence agreement and will void your warranty.



- You can see the touchscreen clearly even in strong outdoor sunlight by automatically adjusting the contrast range based on the surrounding environment. Due to the nature of the product, displaying fixed graphics for extended periods may result in afterimages (screen burn-in) or ghosting.
 - It is recommended not to use fixed graphics on part or all of the touchscreen for extended periods and turn off the touchscreen when not using the device.
 - You can set the touchscreen to turn off automatically when you are not using it. Launch the **Settings** app, tap **Display** → **Screen timeout**, and then select the length of time you want the device to wait before turning off the touchscreen.
 - To set the touchscreen to automatically adjust its brightness based on the surrounding environment, launch the **Settings** app, tap **Display**, and then tap the **Adaptive brightness** switch to activate it.

- Depending on the region or model, some devices are required to receive approval from the Federal Communications Commission (FCC).

If your device is approved by the FCC, you can view the FCC ID of the device. To view the FCC ID, launch the **Settings** app and tap **About phone** → **Status information**. If your device does not have an FCC ID, it means that the device has not been authorised for sale in the U.S. or its territories and may only be brought to the U.S. for the owner's personal use.

- Depending on the region, you can view the regulatory information on the device. To view the information, launch the **Settings** app and tap **About phone** → **Regulatory information**.
- The bandwidths supported by the device may vary depending on the region or service provider.
- 5G network availability may vary depending on the country, network provider, and user environment.
- Your device contains magnets. Keep a safe distance between your device and objects that may be affected by magnets such as credit cards and implantable medical devices. If you have an implantable medical device, consult your physician before use.

Instructional icons

-  **Warning:** situations that could cause injury to yourself or others
-  **Caution:** situations that could cause damage to your device or other equipment
-  **Notice:** notes, usage tips, or additional information

Notes on package contents and accessories

Refer to the quick start guide for package contents.

- The items supplied with the device and any available accessories may vary depending on the region or service provider.
- The supplied items are designed only for this device and may not be compatible with other devices.
- Appearances and specifications are subject to change without prior notice.
- You can purchase additional accessories from your local Samsung retailer. Make sure they are compatible with the device before purchase.
- Use only Samsung-approved accessories. Using unapproved accessories may cause the performance problems and malfunctions that are not covered by the warranty.
- Availability of all accessories is subject to change depending entirely on manufacturing companies. For more information about available accessories, refer to the Samsung website.

Device overheating situations and solutions

When the device heats up while charging the battery

While charging, the device and the charger may become hot. During wireless charging or fast charging, the device may feel hotter to the touch. This does not affect the device's lifespan or performance and is in the device's normal range of operation. If the battery becomes too hot, the charging speed may decrease or the charger may stop charging.

Do the following when the device heats up:

- Disconnect the charger from the device and close any running apps. Wait for the device to cool down and then begin charging the device again.
- If the lower part of the device overheats, it could be because the connected USB cable is damaged. Replace the damaged USB cable with a new Samsung-approved one.
- When using a wireless charger, do not place foreign materials, such as metal objects, magnets, and magnetic stripe cards, between the device and the wireless charger.



The wireless charging or fast charging feature is only available on supported models.

When the device heats up during use

When you use features or apps that require more power or use them for extended periods, your device may temporarily heat up due to increased battery consumption. Close any running apps and do not use the device for a while.

Refer to the following examples of situations in which the device may overheat.

- During the initial setup after purchase or when restoring data
- When downloading large files

- When using apps that require more power or using apps for extended periods
 - When playing high-quality games for extended periods
 - When recording videos for extended periods
 - When streaming videos while using the maximum brightness setting
 - When connecting to a TV
- While multitasking (or, when running many apps in the background)
 - When using Multi window
 - When updating or installing apps while recording videos
 - When downloading large files during a video call
 - When recording videos while using a navigation app
- When using large amount of data for syncing with the cloud, email, or other accounts
- When using a navigation app in a car while the device is placed in direct sunlight
- When using the mobile hotspot and tethering feature
- When using the device in areas with weak signals or no reception
- When charging the battery with a damaged USB cable
- When the device's multipurpose jack is damaged or exposed to foreign materials, such as liquid, dust, metal powder, and pencil lead
- When you are roaming

Do the following when the device heats up:

- Keep the device updated with the latest software.
- Conflicts between running apps may cause the device to heat up. Restart the device.
- Deactivate the Wi-Fi, GPS, and Bluetooth features when not using them.
- Close apps that increase battery consumption or that run in the background when not in use.
- Delete unnecessary files or unused apps.
- Decrease the screen brightness.
- If the device overheats or feels hot for a prolonged period, do not use it for a while. If the device continues to overheat, contact a Samsung Service Centre.

Precautions for device overheating

If you begin to feel uncomfortable due to the device overheating, stop using the device.

When the device heats up, the features and performance may be limited or the device may turn off to cool down. The feature is only available on supported models.

- If the device overheats and reaches a certain temperature, a warning message will appear to prevent device failure, skin irritations and damages, and battery leakage. To lower the device's temperature, the screen brightness and the performance speed will be limited and battery charging will stop. Running apps will be closed and all calling and other features will be limited, except for emergency calls, until the device cools down.
- If the second message appears due to a further increase of the device's temperature, the device will turn off. Do not use the device until the device's temperature drops below the specified level. If the second warning message appears during an emergency call, the call will not be disconnected by a forced shut down.

Precautions for operating environment

Your device may heat up due to the environment in the following conditions. Use caution to avoid shortening the battery's lifespan, damaging the device, or causing a fire.

- Do not store your device in very cold or very hot temperatures.
- Do not expose your device to direct sunlight for extended periods.
- Do not use or store your device for extended periods in very hot areas, such as inside a car in the summertime.
- Do not place the device in any areas that may overheat, such as on an electric heating mat.
- Do not store your device near or in heaters, microwaves, hot cooking equipment, or high pressure containers.
- Do not use a cable whose covering is peeled off or damaged, and do not use any charger or battery that is damaged or malfunctioning.

Appendix

Troubleshooting

Before contacting a Samsung Service Centre, please attempt the following solutions. Some situations may not apply to your device.

You can also use Samsung Members to solve any problems you might encounter while using your device.

When you turn on your device or while you are using the device, it prompts you to enter one of the following codes:

- **Password:** When the device lock feature is enabled, you must enter the password you set for the device.
- **PIN:** When using the device for the first time or when the PIN requirement is enabled, you must enter the PIN supplied with the SIM or USIM card. You can disable this feature by using the Lock SIM card menu.
- **PUK:** Your SIM or USIM card is blocked, usually as a result of entering your PIN incorrectly several times. You must enter the PUK supplied by your service provider.
- **PIN2:** When you access a menu requiring the PIN2, you must enter the PIN2 supplied with the SIM or USIM card. For more information, contact your service provider.

Your device displays network or service error messages

- When you are in areas with weak signals or poor reception, you may lose reception. Move to another area and try again. While moving, error messages may appear repeatedly.
- You cannot access some options without a subscription. For more information, contact your service provider.

Your device does not turn on

When the battery is completely discharged, your device will not turn on. Fully charge the battery before turning on the device.

The touchscreen responds slowly or improperly

- If you attach a screen protector or optional accessories to the touchscreen, the touchscreen may not function properly.
- If you are wearing gloves, if your hands are not clean while touching the touchscreen, or if you tap the screen with sharp objects or your fingertips, the touchscreen may malfunction.
- The touchscreen may malfunction in humid conditions or when exposed to water.
- Restart your device to clear any temporary software bugs.
- Ensure that your device software is updated to the latest version.
- If the touchscreen is scratched or damaged, visit a Samsung Service Centre.

Your device freezes or encounters a fatal error

Try the following solutions. If the problem is still not resolved, contact a Samsung Service Centre.

Restarting the device

If your device freezes or hangs, you may need to close apps or turn off the device and turn it on again.

Forcing restart

If your device is frozen and unresponsive, press and hold the Side key and the Volume Down key simultaneously for more than 7 seconds to restart it.

Resetting the device

If the methods above do not solve your problem, perform a factory data reset.

Launch the **Settings** app and tap **General management** → **Reset** → **Factory data reset** → **Reset** → **Delete all**. Before performing the factory data reset, remember to make backup copies of all important data stored in the device.

Calls are not connected

- Ensure that you have accessed the right cellular network.
- Ensure that you have not set call barring for the phone number you are dialling.
- Ensure that you have not set call barring for the incoming phone number.

Others cannot hear you speaking on a call

- Ensure that you are not covering the built-in microphone.
- Ensure that the microphone is close to your mouth.
- If using an earphone, ensure that it is properly connected.

Sound echoes during a call

Adjust the volume by pressing the Volume key or move to another area.

A cellular network or the Internet is often disconnected or audio quality is poor

- Ensure that you are not blocking the device's internal antenna.
- When you are in areas with weak signals or poor reception, you may lose reception. You may have connectivity problems due to issues with the service provider's base station. Move to another area and try again.
- When using the device while moving, wireless network services may be disabled due to issues with the service provider's network.

The battery does not charge properly (For Samsung-approved chargers)

- Ensure that the charger is connected properly.
- Visit a Samsung Service Centre and have the battery replaced.

The battery depletes faster than when first purchased

- When you expose the device or the battery to very cold or very hot temperatures, the useful charge may be reduced.
- Battery consumption will increase when you use certain features or apps, such as GPS, games, or the Internet.
- The battery is consumable and the useful charge will get shorter over time.

Error messages appear when launching the camera

Your device must have sufficient available memory and battery power to operate the camera app. If you receive error messages when launching the camera, try the following:

- Charge the battery.
- Free some memory by transferring files to a computer or deleting files from your device.
- Restart the device. If you are still having trouble with the camera app after trying these tips, contact a Samsung Service Centre.

Picture quality is poorer than the preview

- The quality of your pictures may vary, depending on the surroundings and the photography techniques you use.
- If you take pictures in dark areas, at night, or indoors, image noise may occur or images may be out of focus.

Error messages appear when opening multimedia files

If you receive error messages or multimedia files do not play when you open them on your device, try the following:

- Free some memory by transferring files to a computer or deleting files from your device.
- Ensure that the music file is not Digital Rights Management (DRM)-protected. If the file is DRM-protected, ensure that you have the appropriate licence or key to play the file.
- Ensure that the file formats are supported by the device. If a file format is not supported, such as DivX or AC3, install an app that supports it. To confirm the file formats that your device supports, visit the Samsung website.
- Your device supports pictures and videos captured with the device. Pictures and videos captured by other devices may not work properly.
- Your device supports multimedia files that are authorised by your network service provider or providers of additional services. Some content circulated on the Internet, such as ringtones, videos, or wallpapers, may not work properly.

Bluetooth is not working well

If another Bluetooth device is not located or there are connection problems or performance malfunctions, try the following:

- Ensure that the device you wish to connect with is ready to be scanned or connected to.
- Ensure that your device and the other Bluetooth device are within the maximum Bluetooth range (10 m).
- On your device, launch the **Settings** app, tap **Connections**, and then tap the **Bluetooth** switch to re-activate it.
- On your device, launch the **Settings** app, tap **General management** → **Reset** → **Reset network settings** → **Reset settings** → **Reset** to reset network settings. You may lose registered information when performing the reset.

If the tips above do not solve the problem, contact a Samsung Service Centre.

The screen brightness adjustment bar does not appear on the notification panel

Open the notification panel by dragging the status bar downwards, and then drag the notification panel downwards. Tap  → **Quick panel layout** → **Brightness control** → **Show always**.

A connection is not established when you connect the device to a computer

- Ensure that the USB cable you are using is compatible with your device.
- Ensure that you have the proper driver installed and updated on your computer.

Your device cannot find your current location

GPS signals may be obstructed in some locations, such as indoors. Set the device to use Wi-Fi or a mobile network to find your current location in these situations.

Data stored in the device has been lost

Always make backup copies of all important data stored in the device. Otherwise, you cannot restore data if it is corrupted or lost. Samsung is not responsible for the loss of data stored in the device.

A small gap appears around the outside of the device case

- This gap is a necessary manufacturing feature and some minor rocking or vibration of parts may occur.
- Over time, friction between parts may cause this gap to expand slightly.

There is not enough space in the device's storage

Delete unnecessary data, such as cache, using the device care feature or manually delete unused apps or files to free up storage space.

The Home button does not appear

The navigation bar containing the Home button may disappear while using certain apps or features. To view the navigation bar, drag upwards from the bottom of the screen.

Removing the battery

- **To remove the battery, contact an authorised service centre. To obtain battery removal instructions, please visit www.samsung.com/global/ecodesign_energy.**
- For your safety, you **must not attempt to remove** the battery. If the battery is not properly removed, it may lead to damage to the battery and device, cause personal injury, and/or result in the device being unsafe.
- Samsung does not accept liability for any damage or loss (whether in contract or tort, including negligence) which may arise from failure to precisely follow these warnings and instructions, other than death or personal injury caused by Samsung's negligence.

Copyright

Copyright © 2022 Samsung Electronics Co., Ltd.

This manual is protected under international copyright laws.

No part of this manual may be reproduced, distributed, translated, or transmitted in any form or by any means, electronic or mechanical, including photocopying, recording, or storing in any information storage and retrieval system.

Trademarks

- SAMSUNG and the SAMSUNG logo are registered trademarks of Samsung Electronics Co., Ltd.
- Bluetooth® is a registered trademark of Bluetooth SIG, Inc. worldwide.
- Wi-Fi®, Wi-Fi Direct™, Wi-Fi CERTIFIED™, and the Wi-Fi logo are registered trademarks of the Wi-Fi Alliance.
- Manufactured under license from Dolby Laboratories. Dolby, Dolby Atmos, and the double-D symbol are trademarks of Dolby Laboratories.
- All other trademarks and copyrights are the property of their respective owners.