

**HIDDEN
SIDE**



70433



1



2



3



4



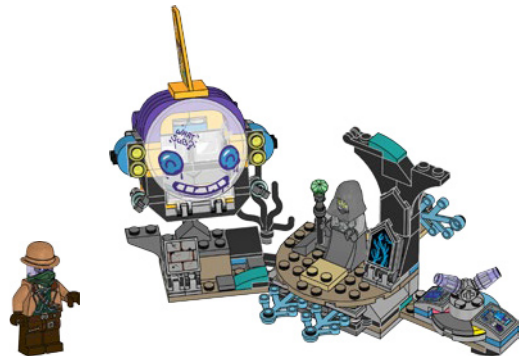
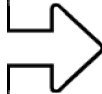
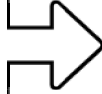





HIDDEN SIDE™

FREE INTERACTIVE APP

Kostenlose interaktive App
 Appli interactiva gratuita
 App interattiva gratuita
 App interactiva gratis
 App interactiva grátiš
 Ingyenes interaktív alkalmazás
 Bezmaksas interaktíva lietotne
 免费交互式应用程序



LEGO® Hidden Side™
LEGO.com/devicecheck

Check for compatibility
 Kompatibilität prüfen
 Vérifier la compatibilité
 Controlla la compatibilità
 Comprueba tu compatibilidad
 Verificar a compatibilidade
 Ellenőrizd a kompatibilitást
 Pārbaudīt saderību
 检查兼容性

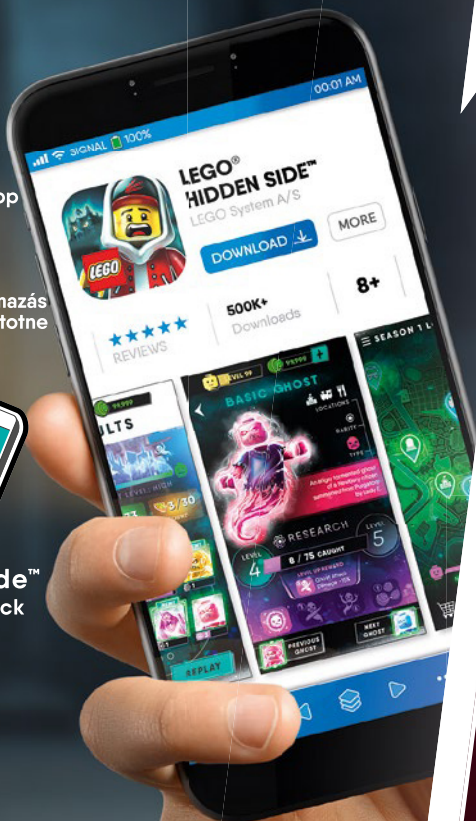

Play in a well-lit area.

Spieler in einem gut beleuchteten Bereich.
 Joue dans un endroit bien éclairé.
 Posiziona il set in un'area ben illuminata.
 Juega en un área bien iluminada.
 Joga numa área bem iluminada.
 Játssz jól megvilágított területen!
 Rotalājies labi apgaismotā zonā.
 请在光线充足的地方玩乐。

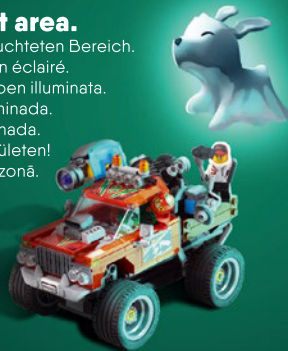

Play on a clean, flat surface.

Spieler auf einer sauberen und ebenen Oberfläche.
 Joue sur une surface propre et plane.
 Posiziona il set su una superficie pulita e piana.
 Juega sobre una superficie lisa y despejada.
 Joga sobre uma superfície plana e limpa.
 Játssz tiszta, sík felületen!
 Rotalājies uz tīras, līdzenas virsmas.
 请在干净平整的表面上玩乐。



Avoid patterned and reflective surfaces.

Vermeide gemusterte und spiegelnde Oberflächen.
 Évite les surfaces à motifs et réfléchissantes.
 Evita superfici riflettenti, con disegni o motivi.
 Evita las superficies decoradas con patrones y reflectantes.
 Evita superficies refletoras e com motivos decorativos.
 Kerüld a mintás és visszaturkórozódó felületeket!
 Neizmanto virsmas ar rakstu vai atstarojošas virsmas.
 避免使用带图案和可反光的表面。



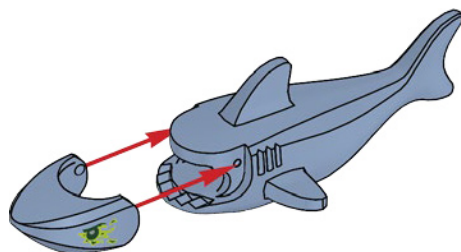
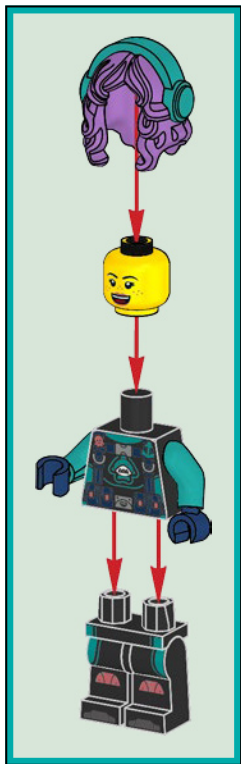

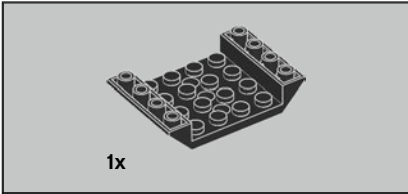
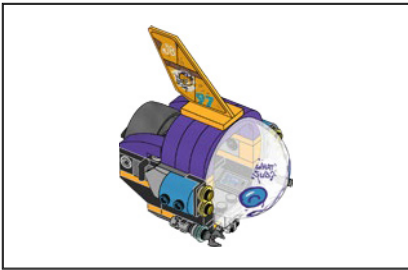

1

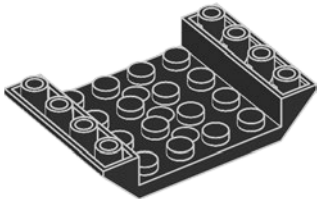

2

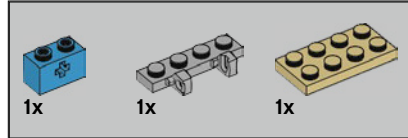
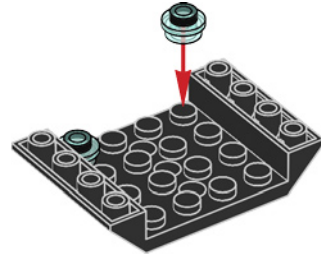

3

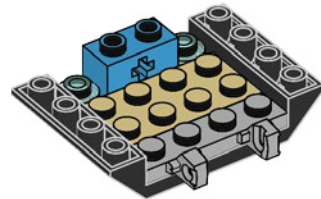

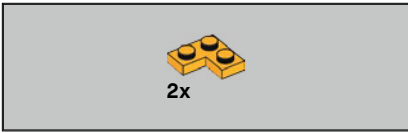

4

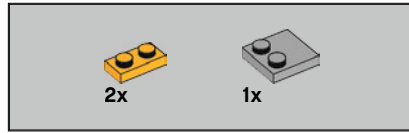
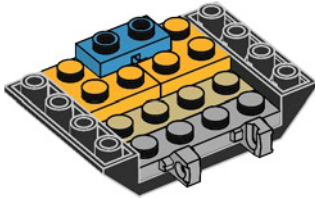

5

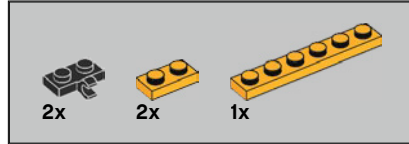
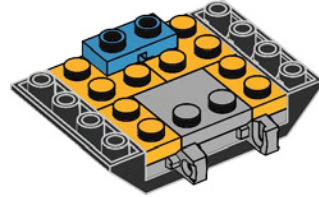

6

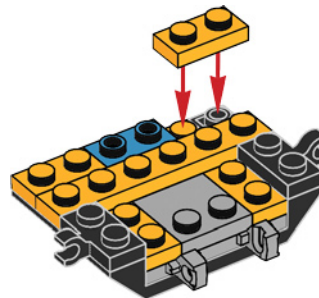

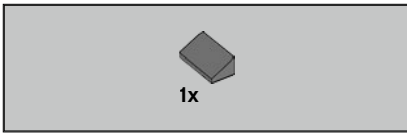

7

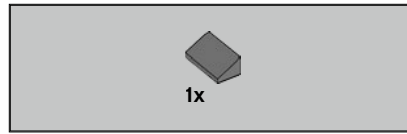
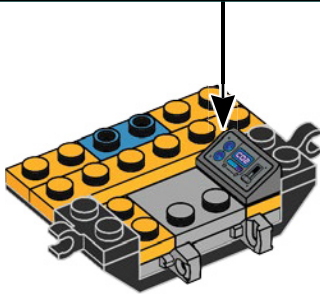

8

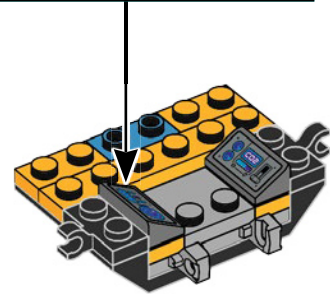
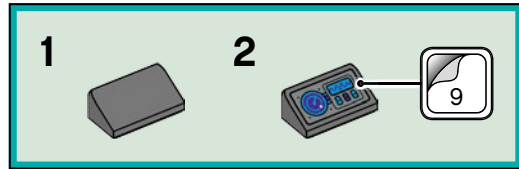

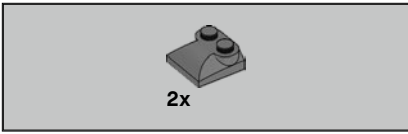

9

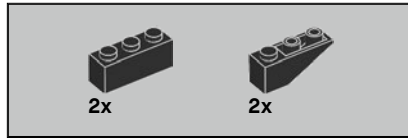

10

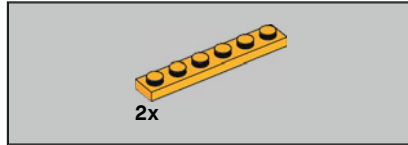
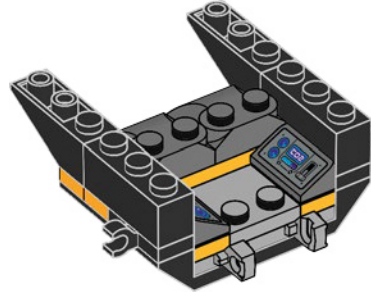

11

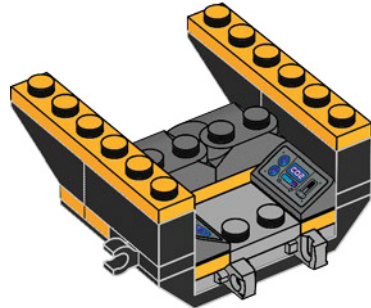

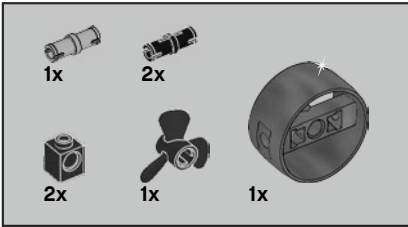

12

1



2

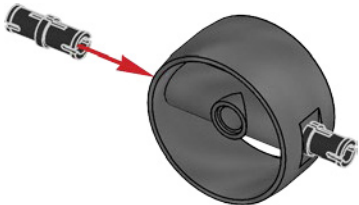

3

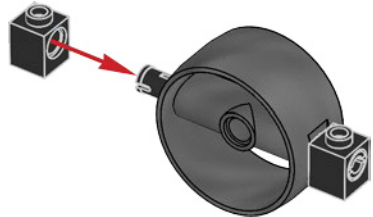

4

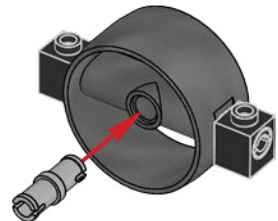

5

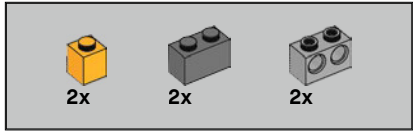
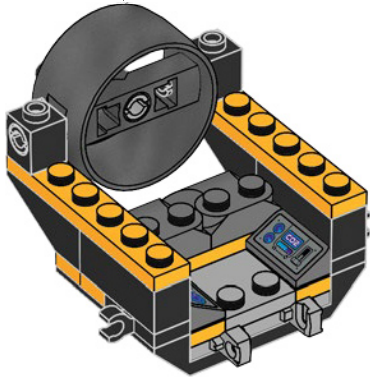
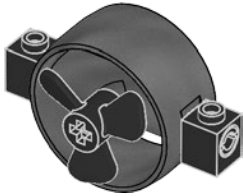

13

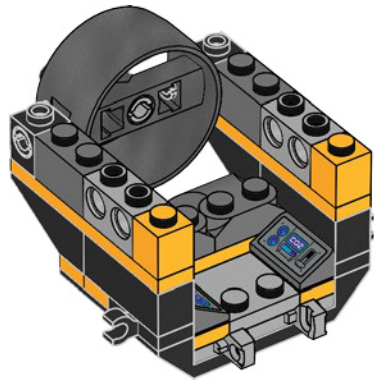

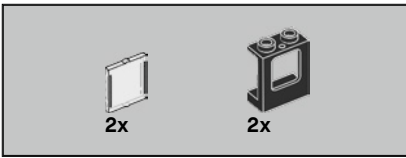

14

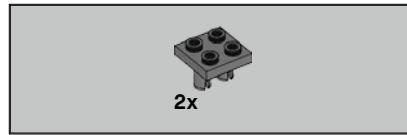
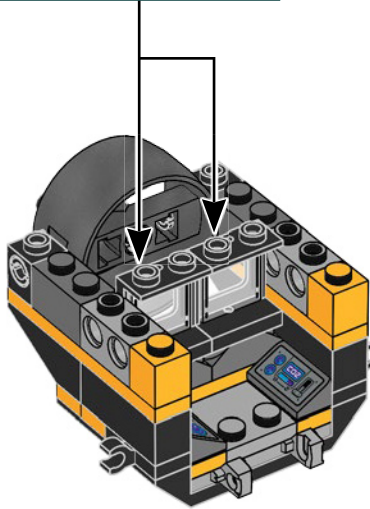
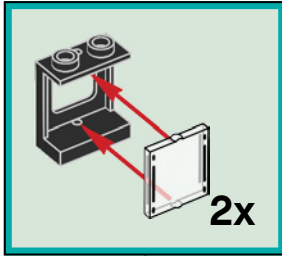

15

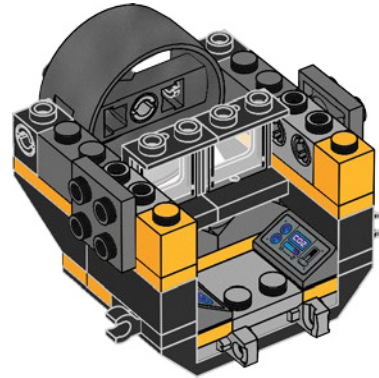



16

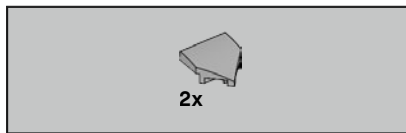
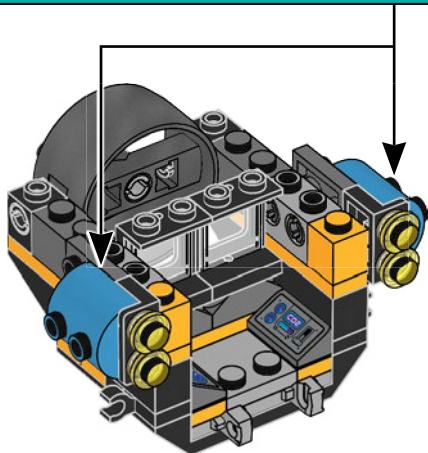
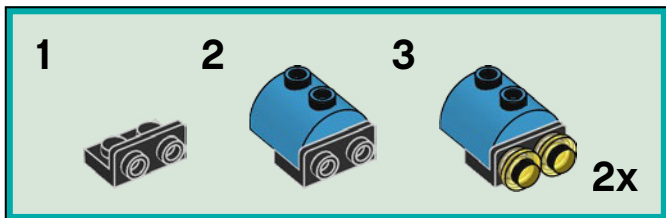

17

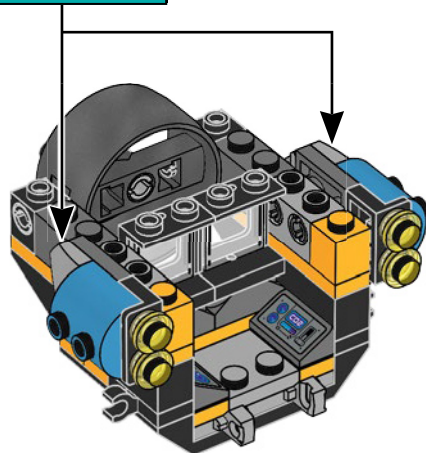

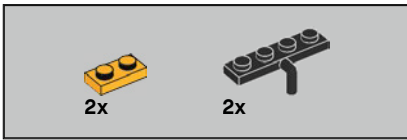

18

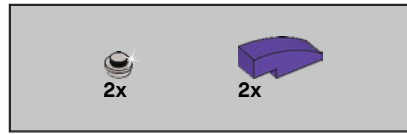
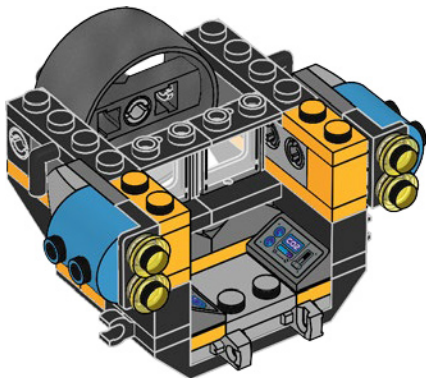

19

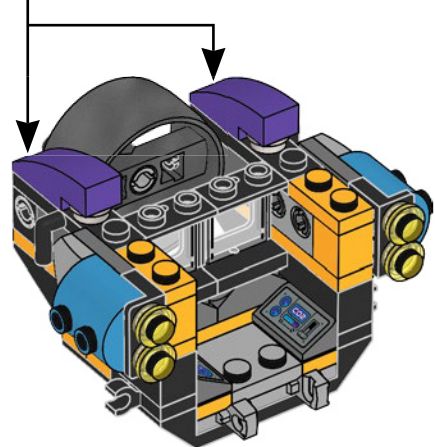
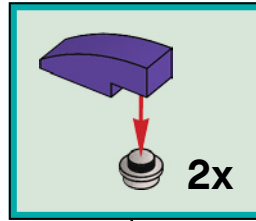

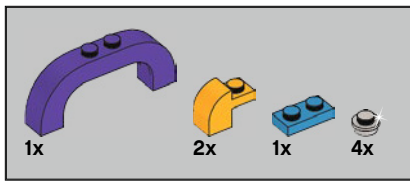

20

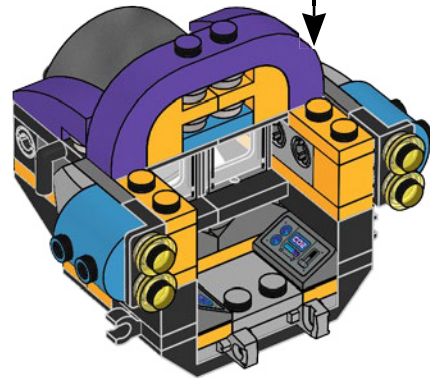
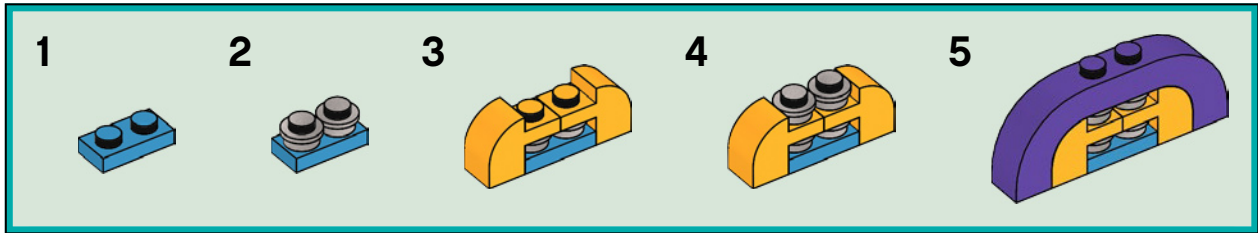

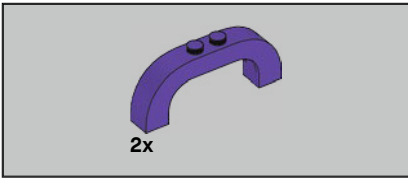

21

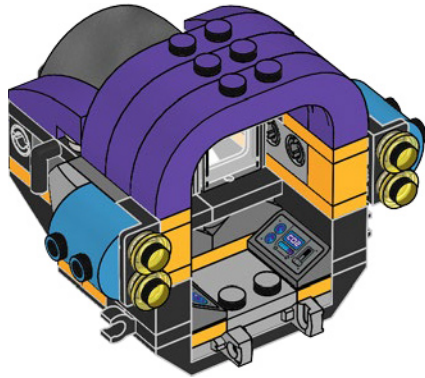

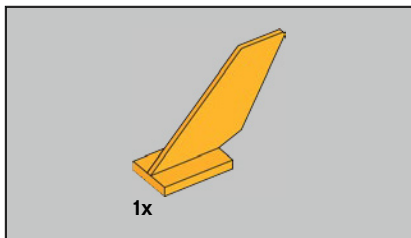

22

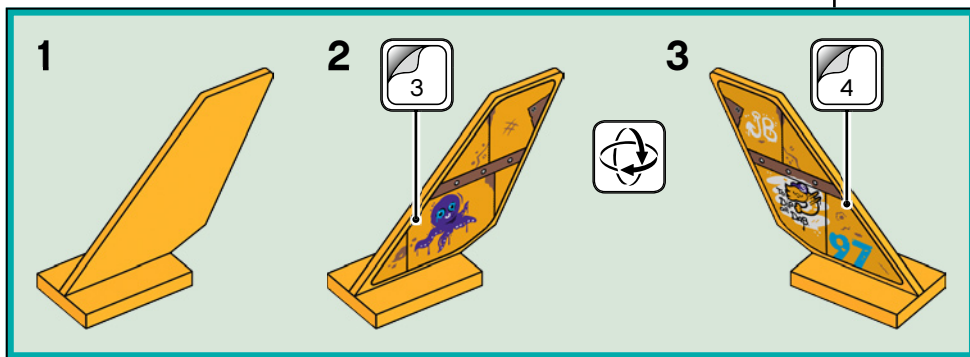
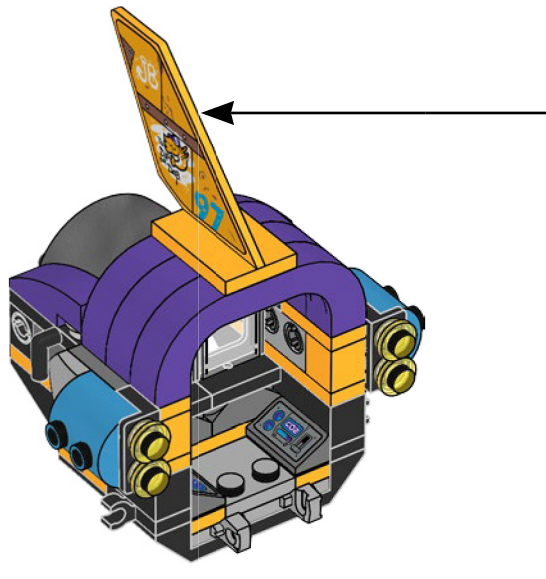



23

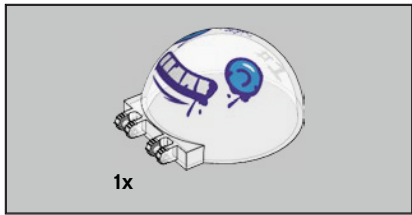
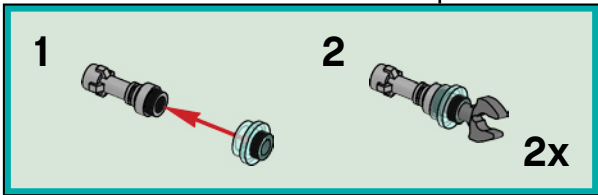
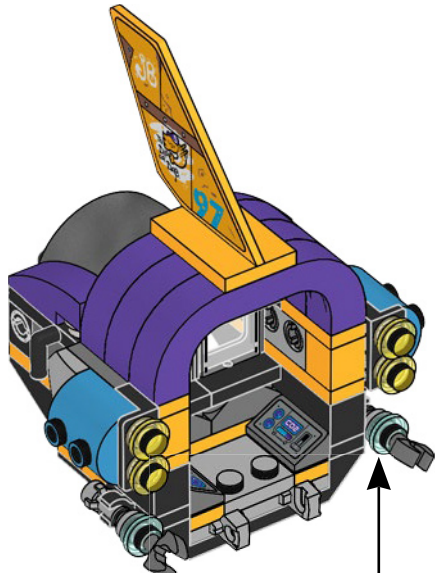

24

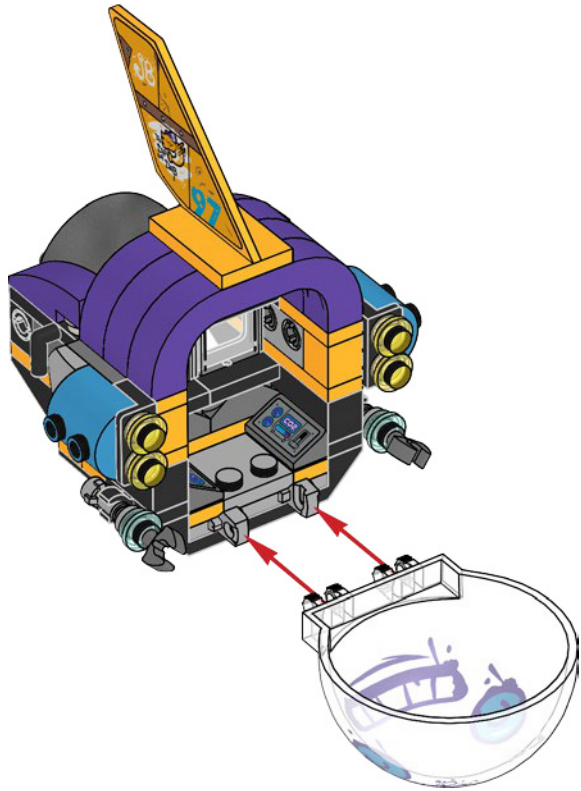

25

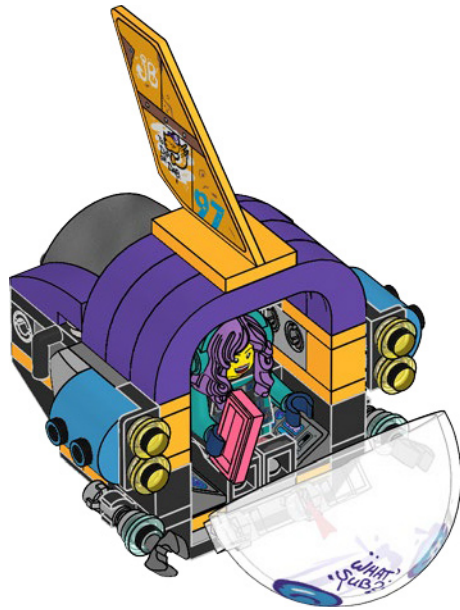

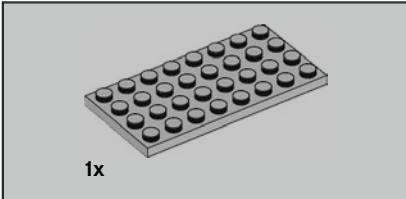
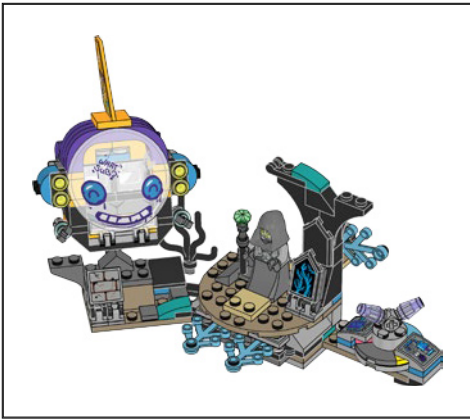

26

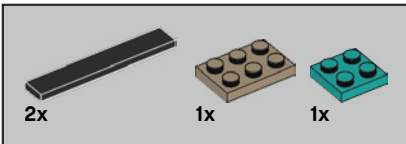
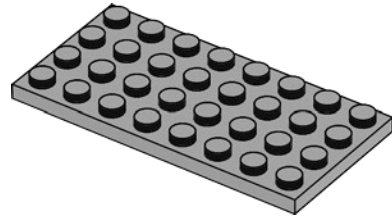

27

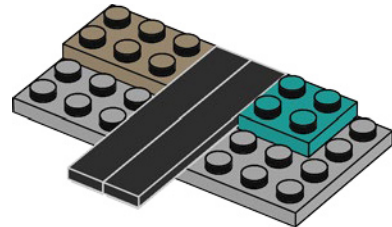

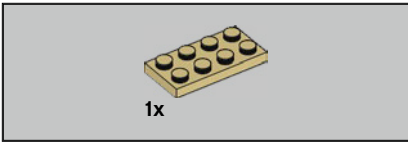

28

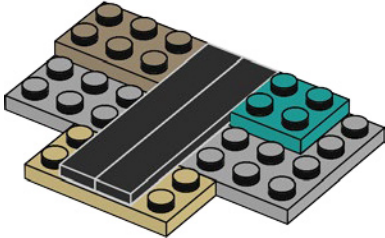

29

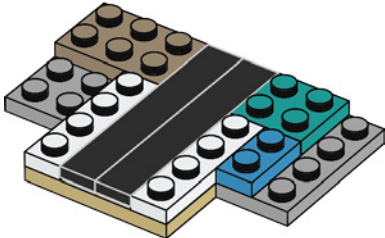

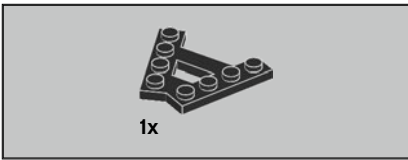

30

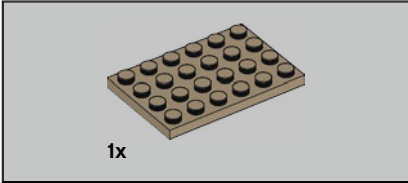
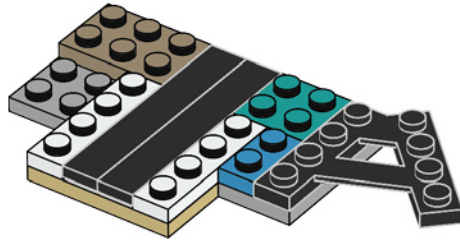

31

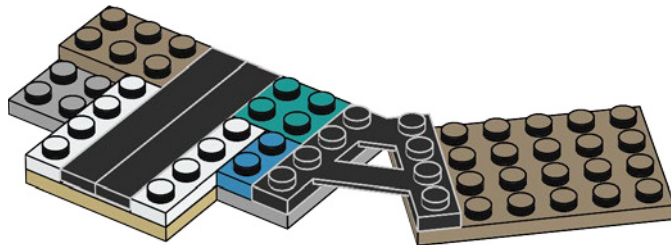

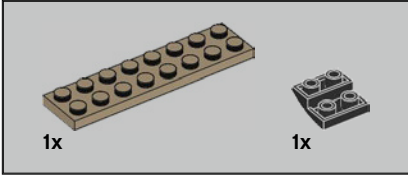
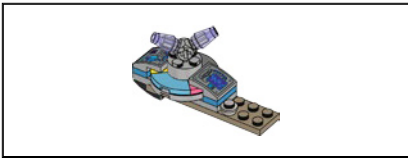

32

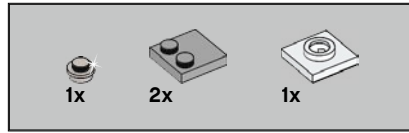
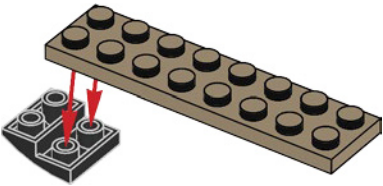

33

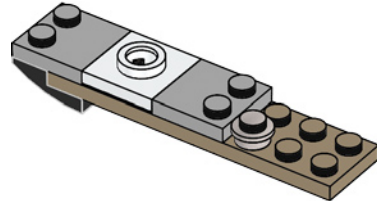

34

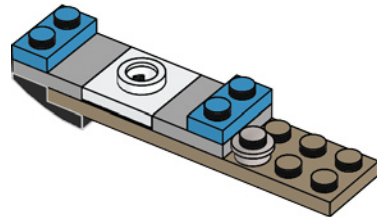

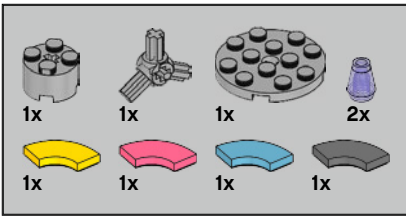

35

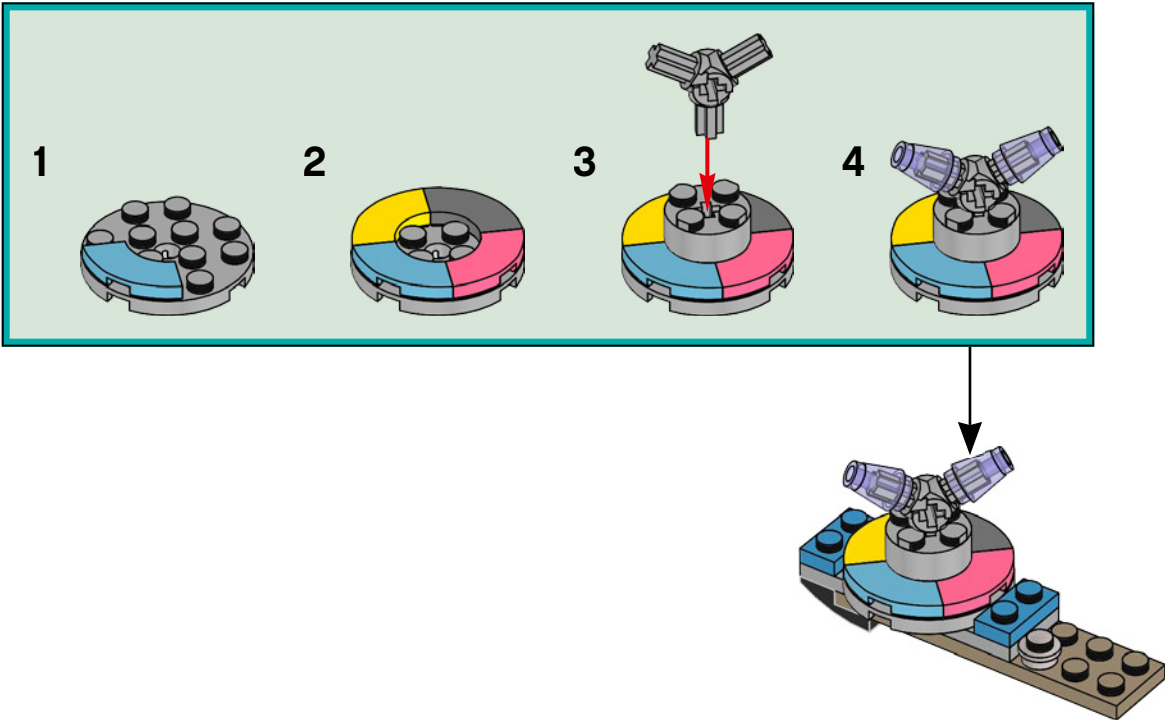

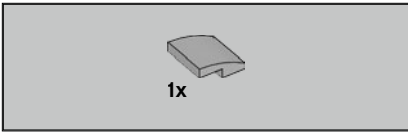

36

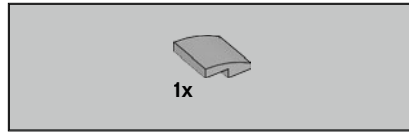
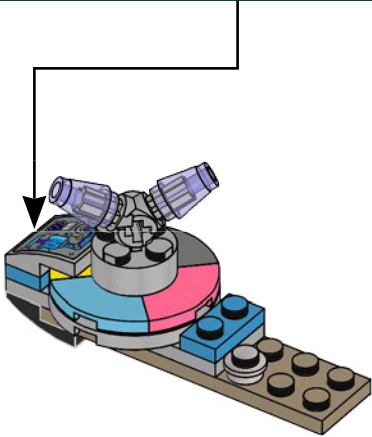
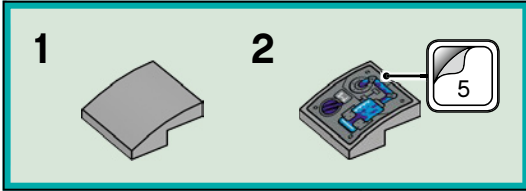

37

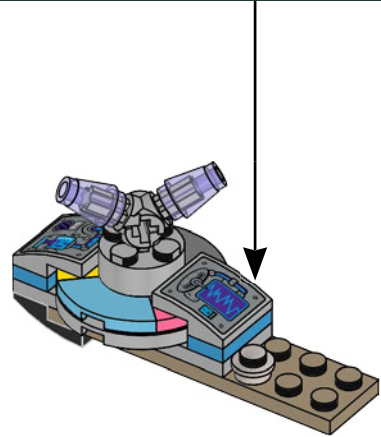
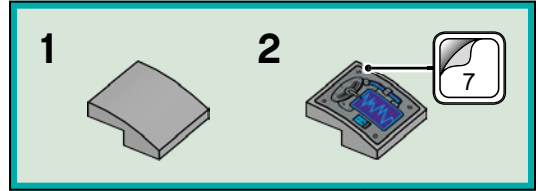

38

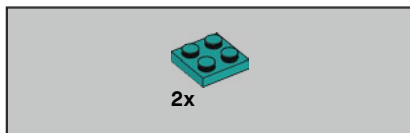
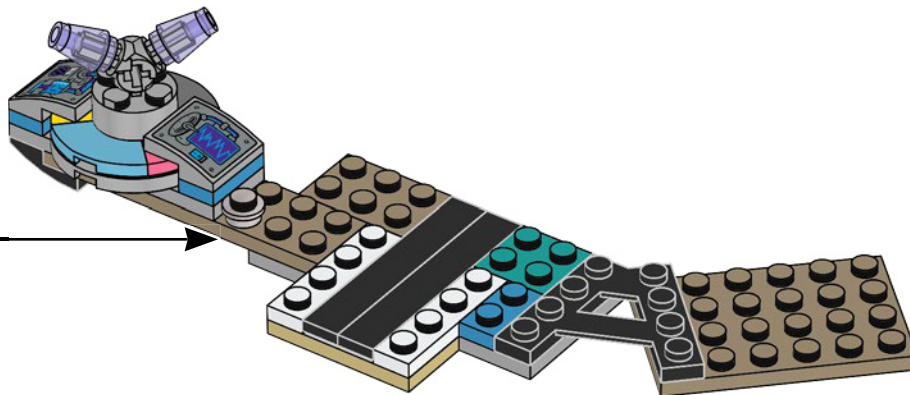

39

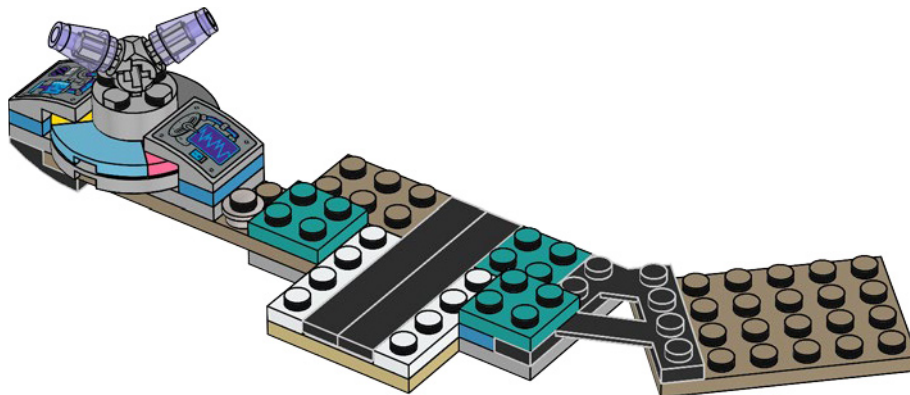

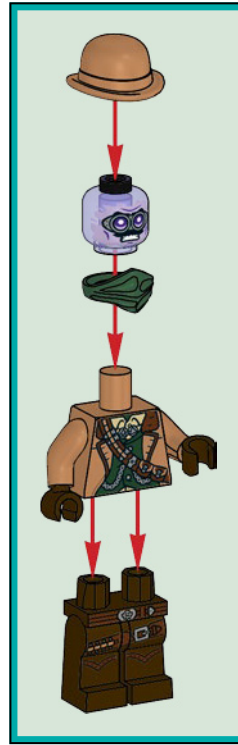
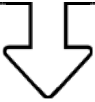



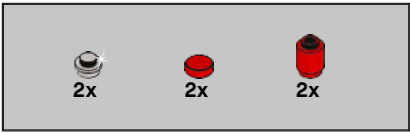

40

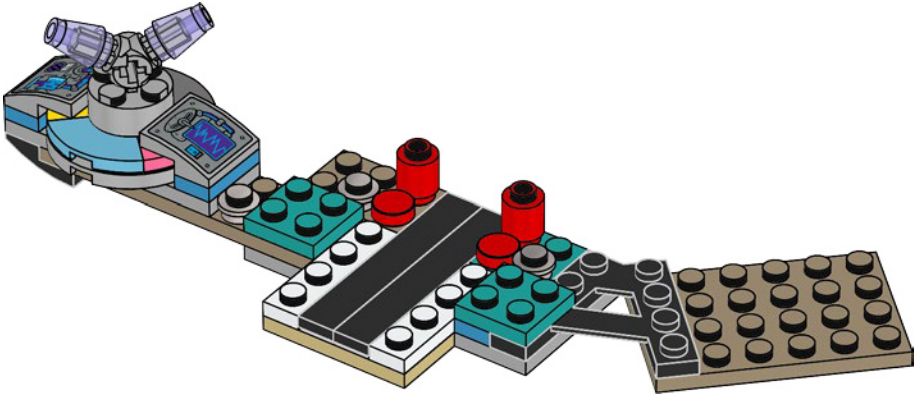

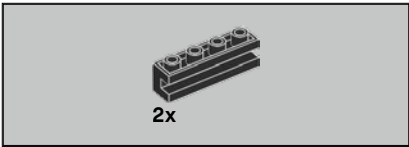

41

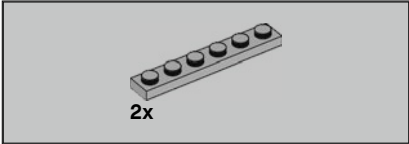
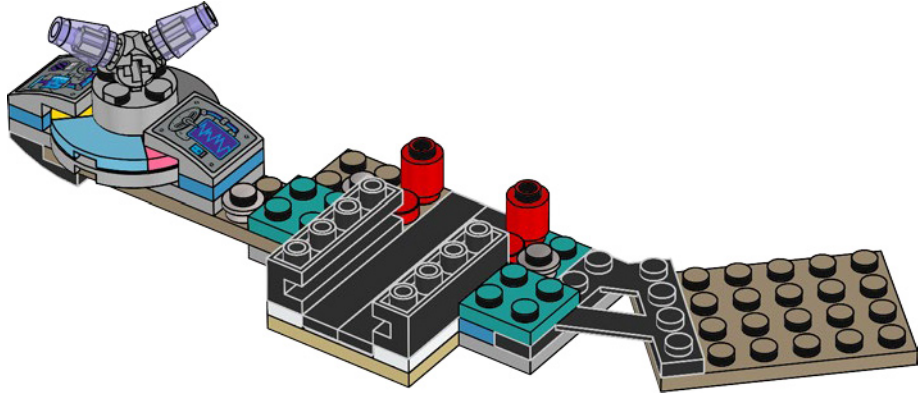

42

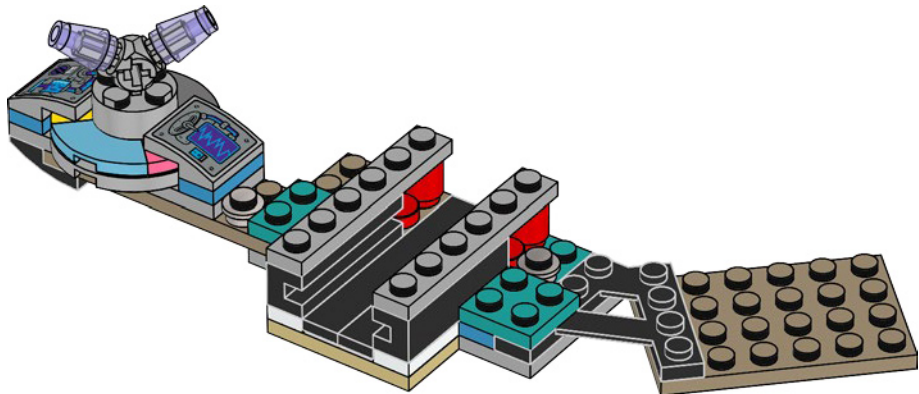

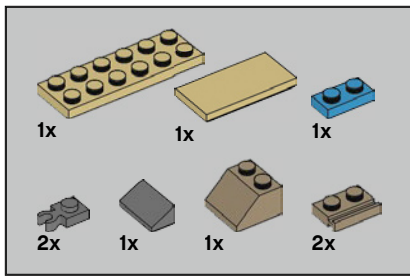

43

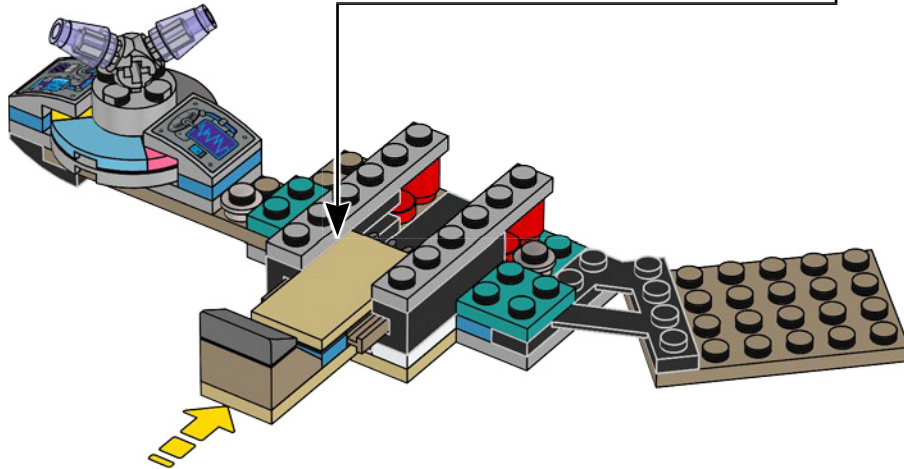
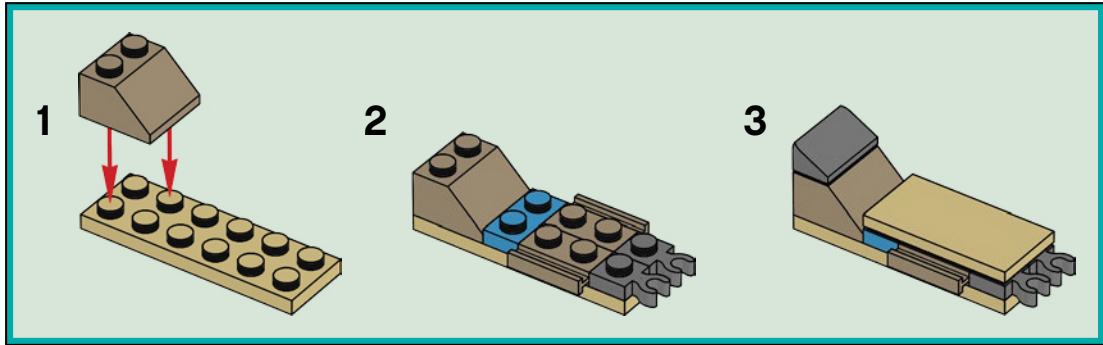

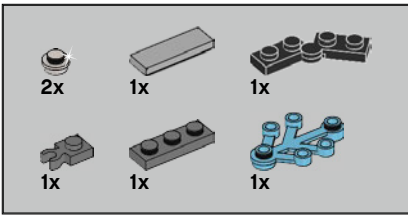

44

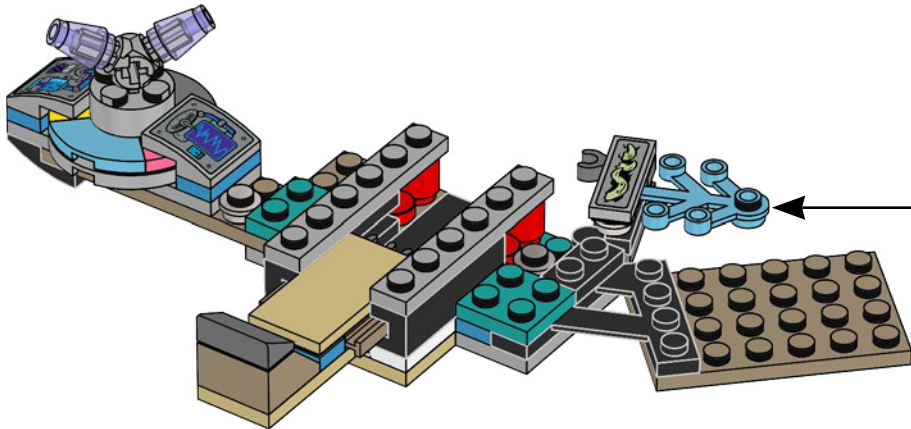
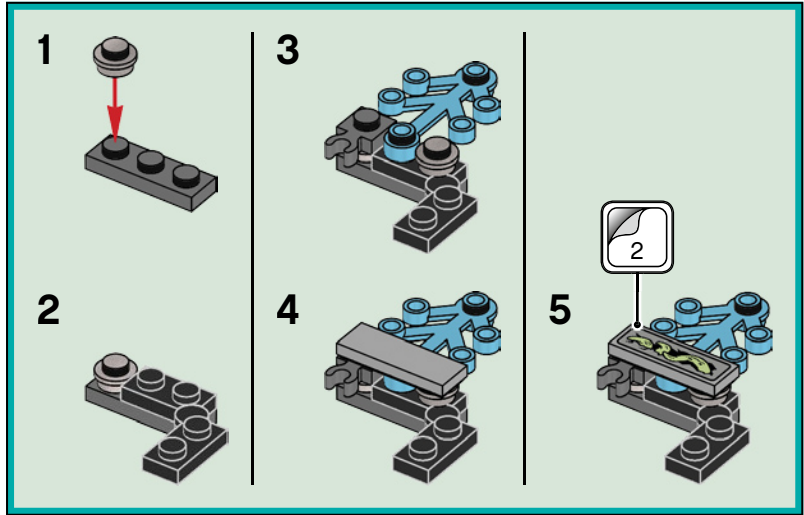

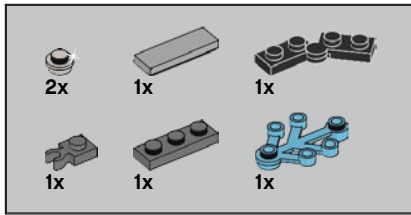

45

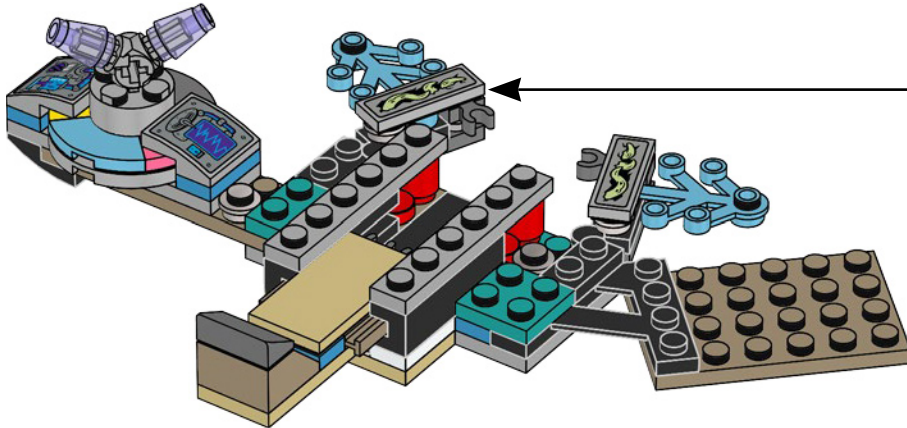
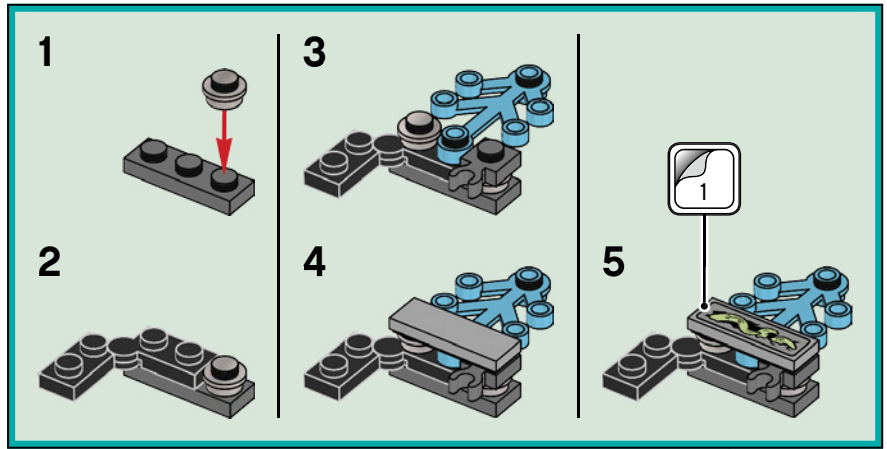

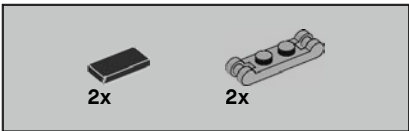

46

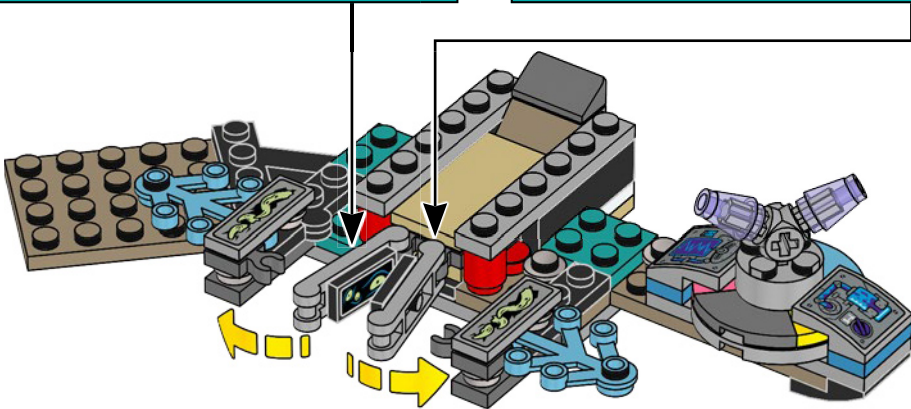
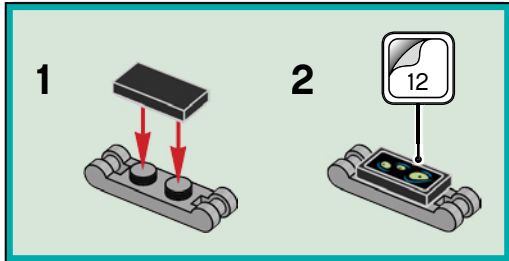
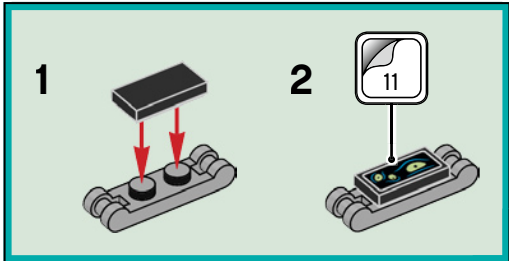

1

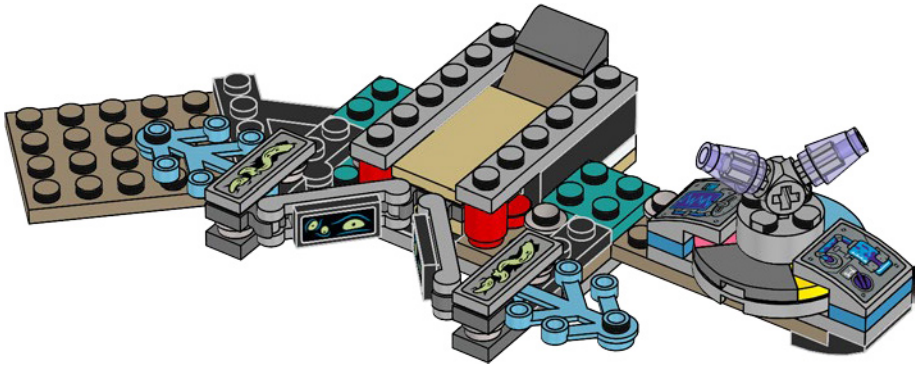

2

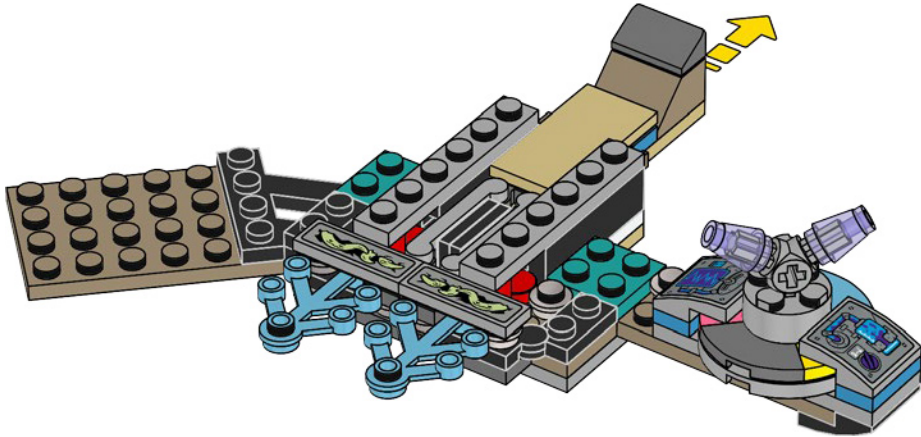

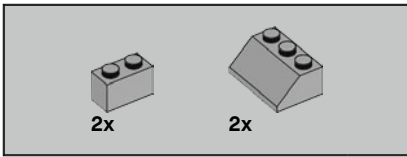

47

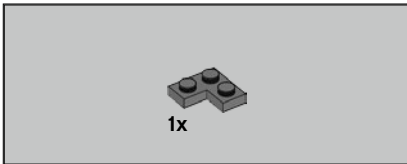
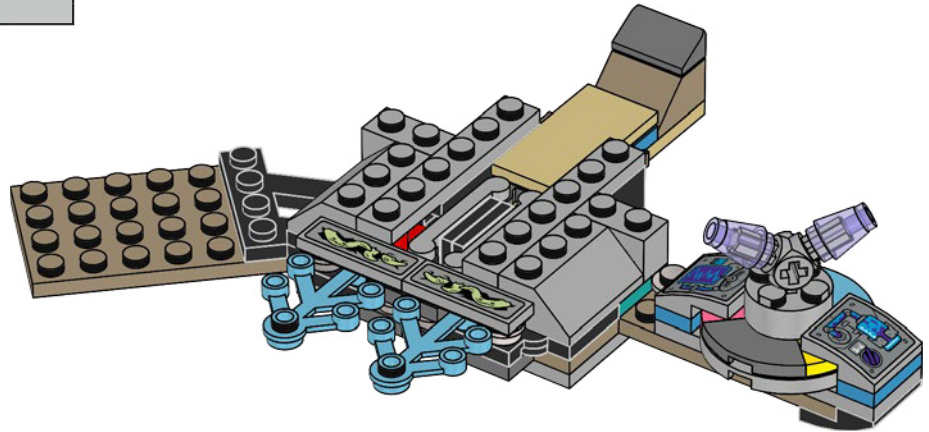

48

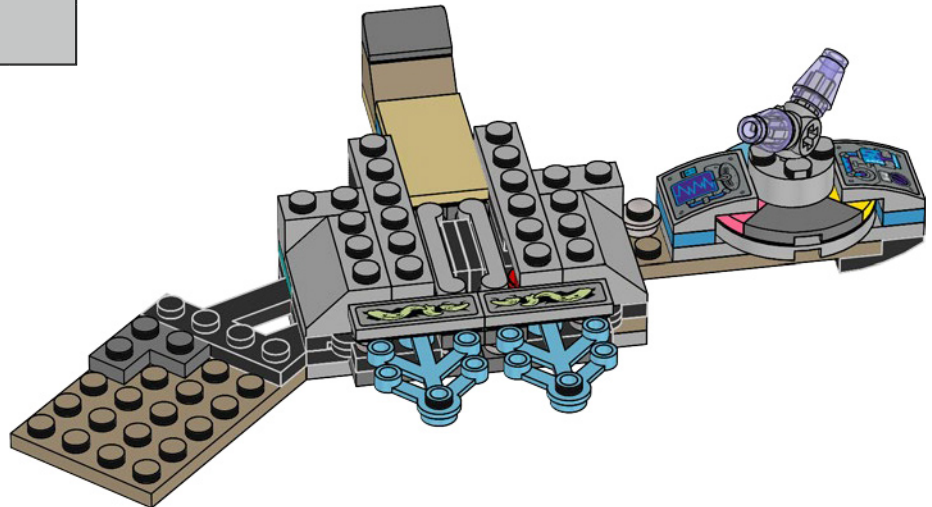

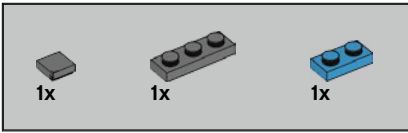

49

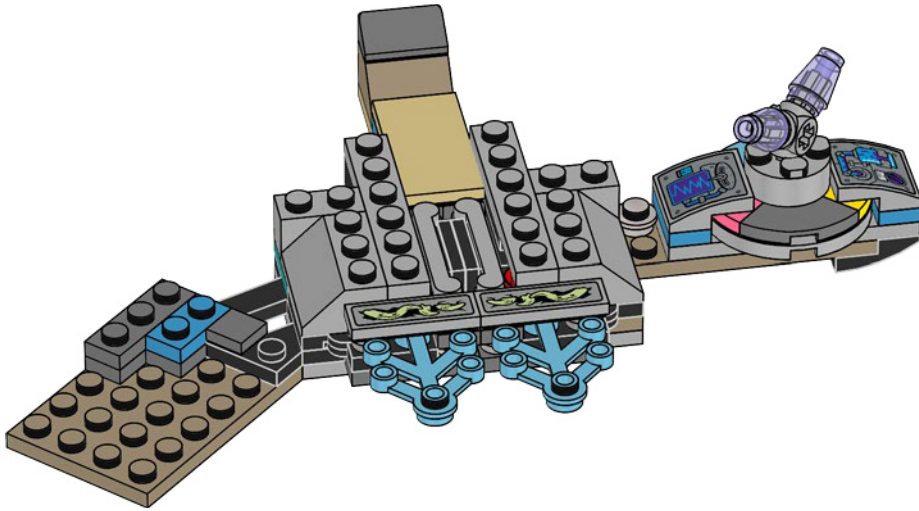

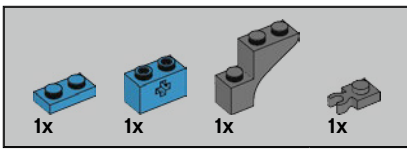

50

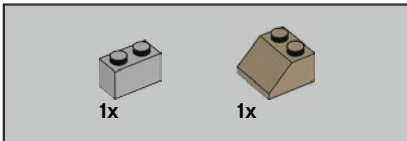
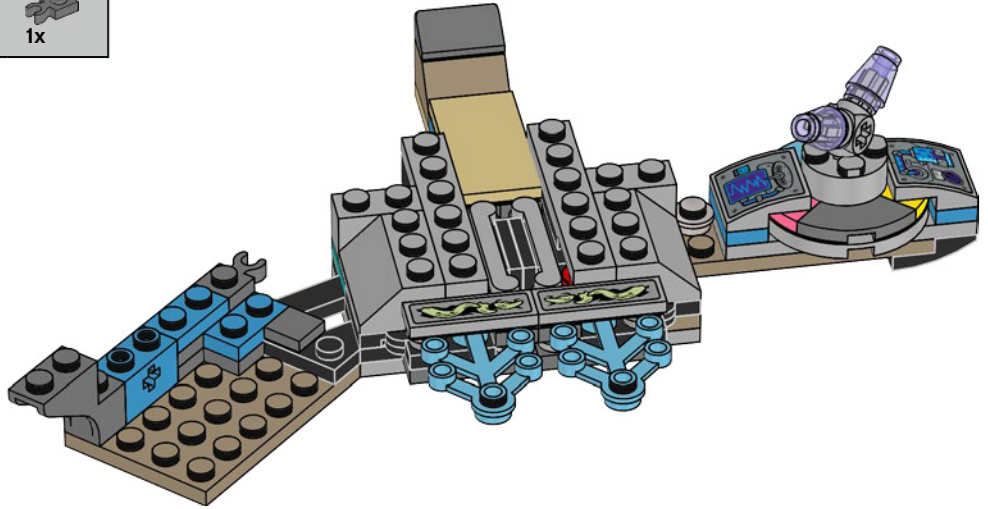

51

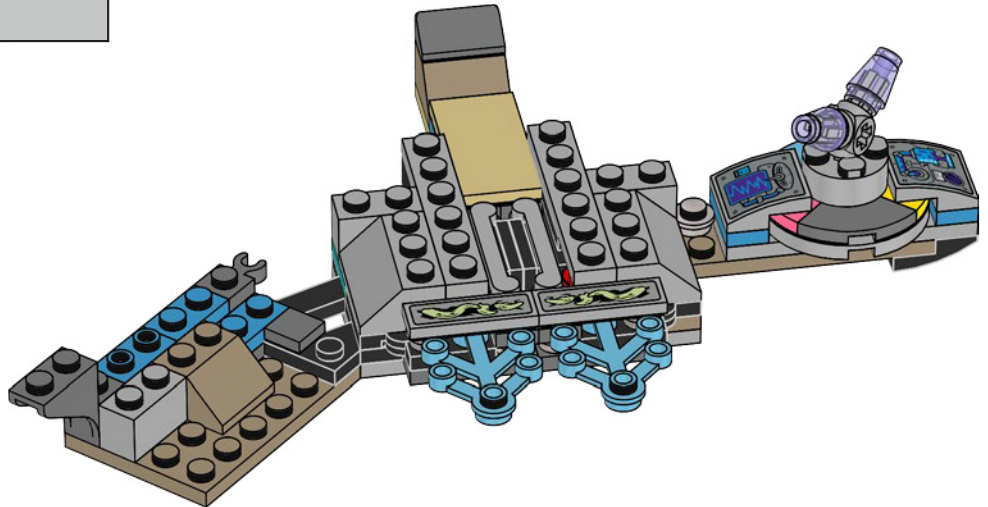

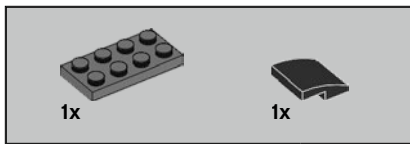

52

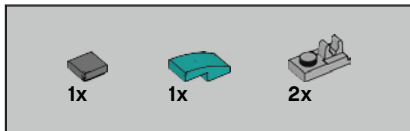
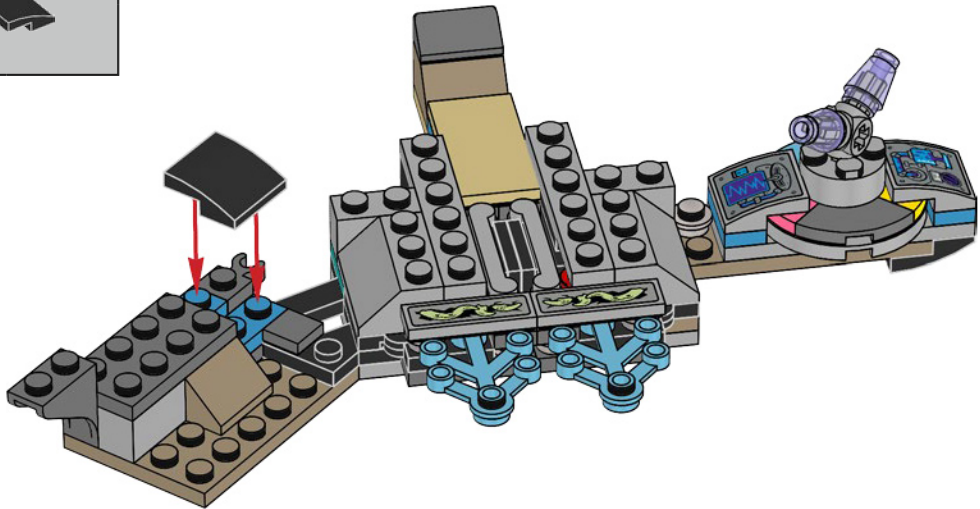

53

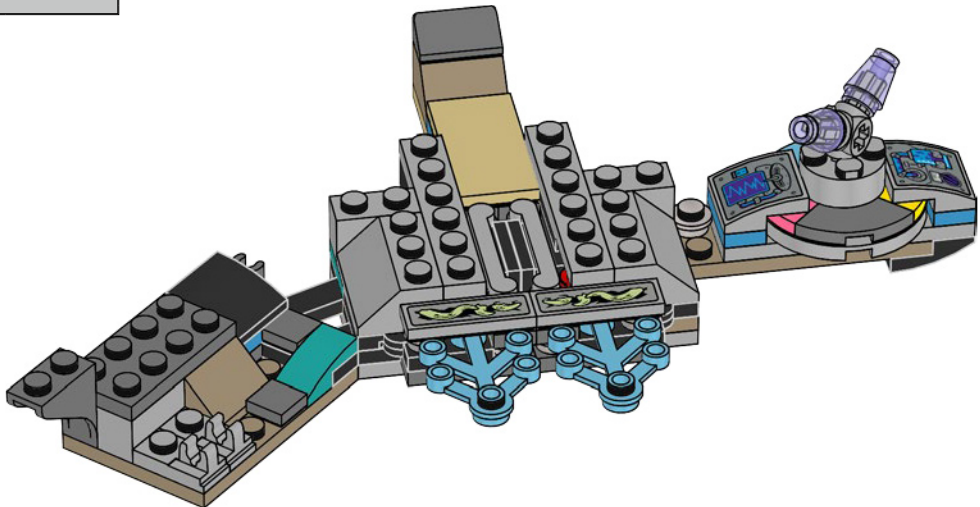

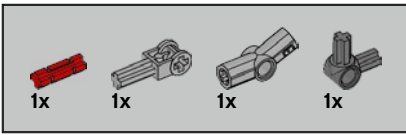

54

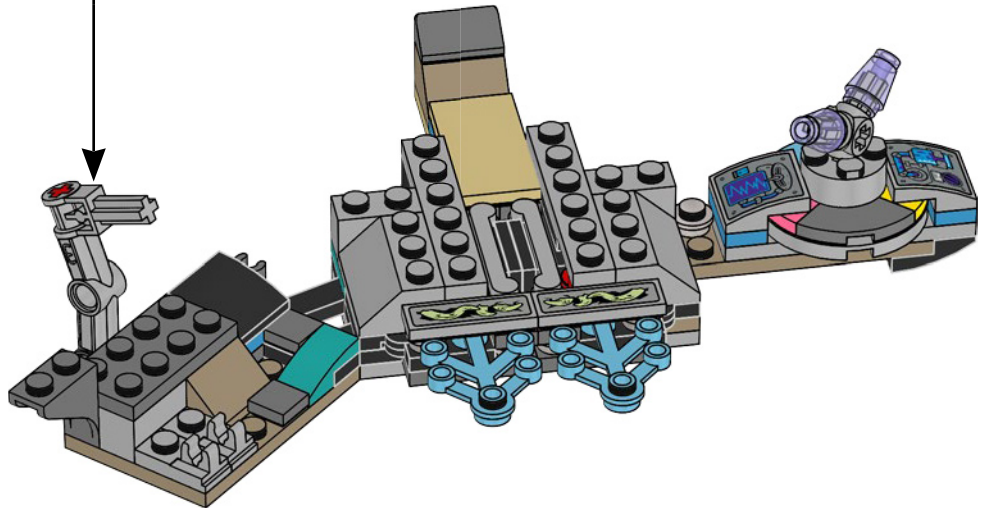
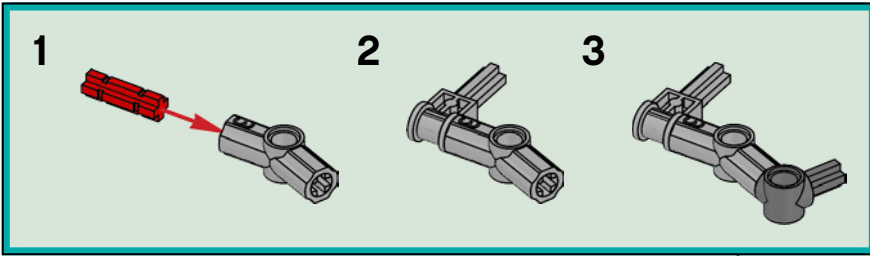
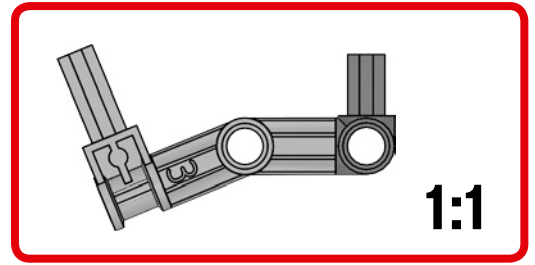

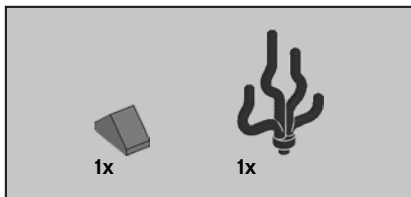

55

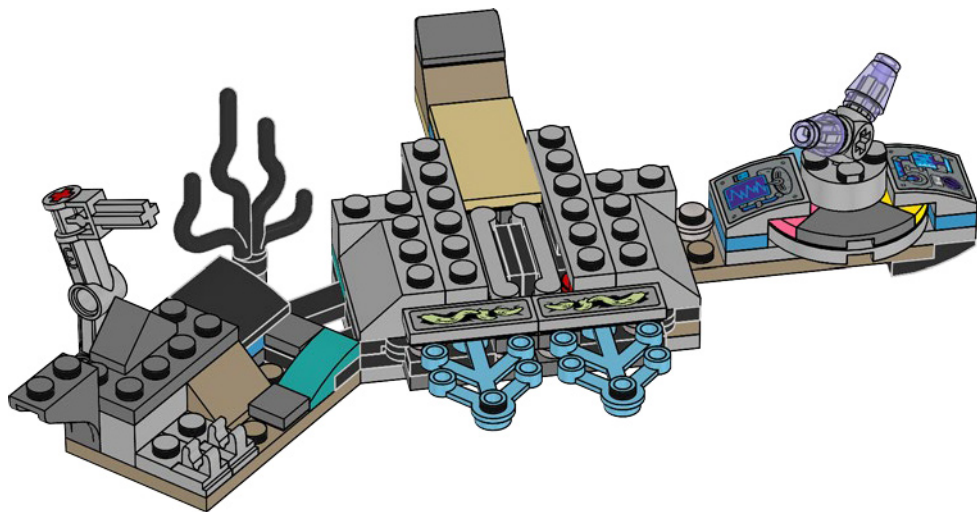

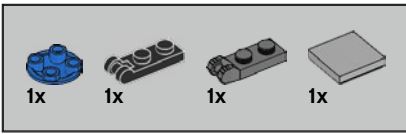

56

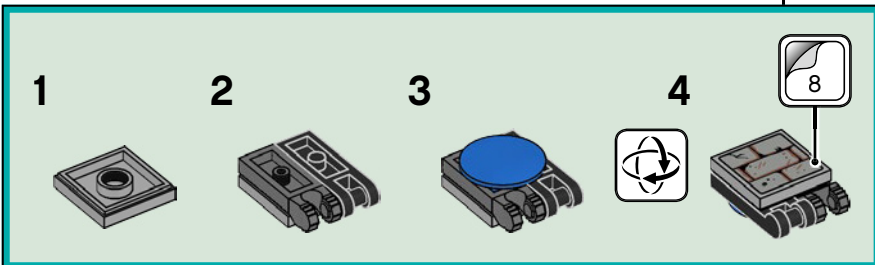
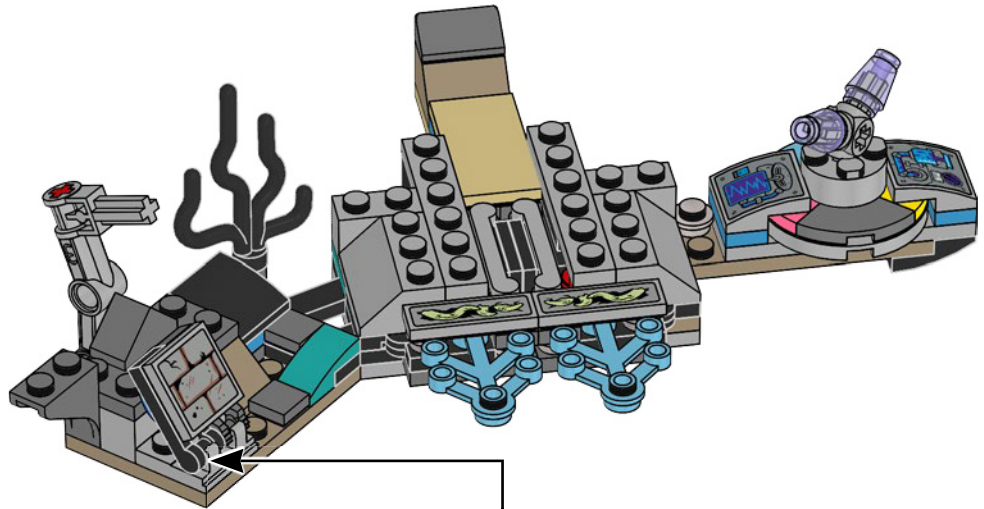

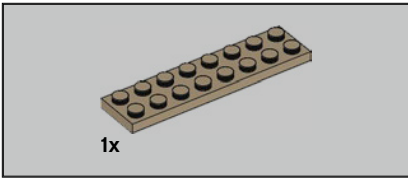

57

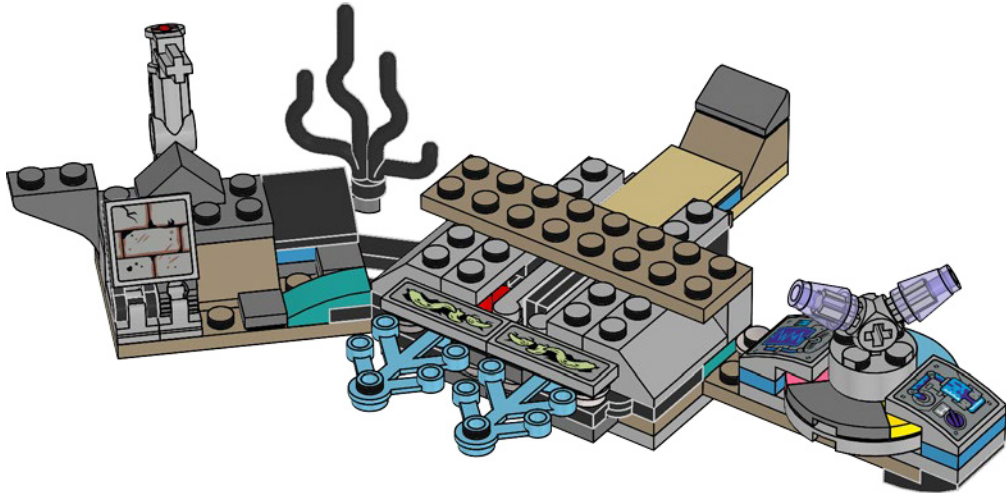

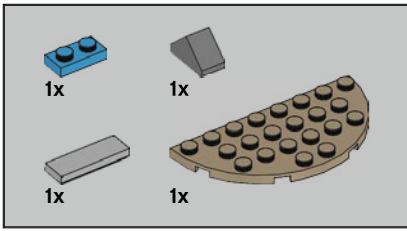

58

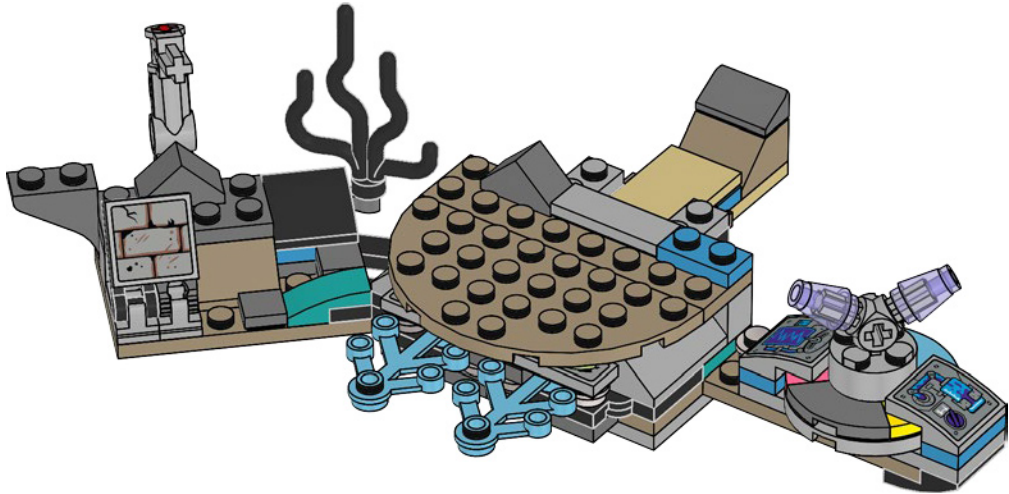

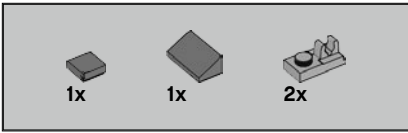

59

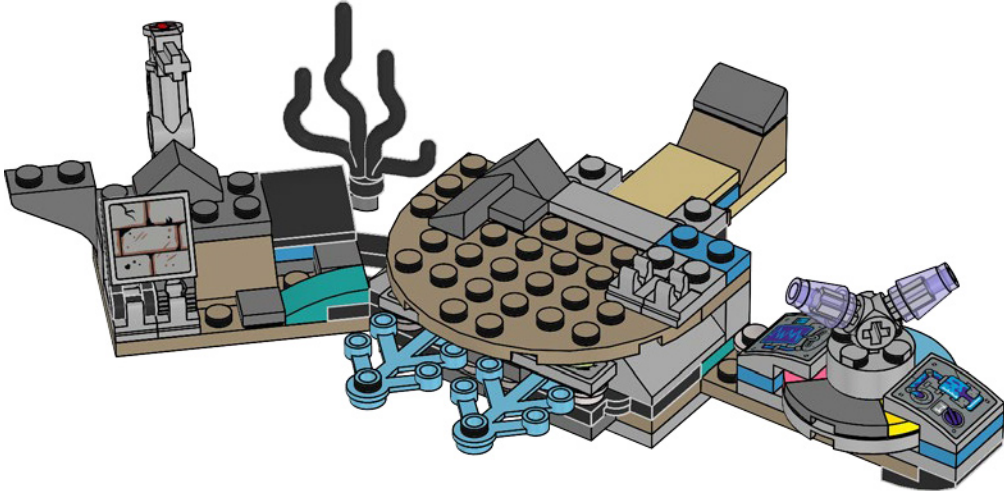

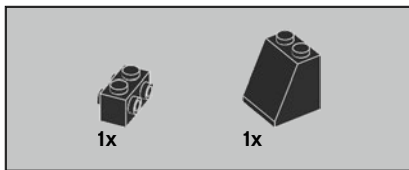

60

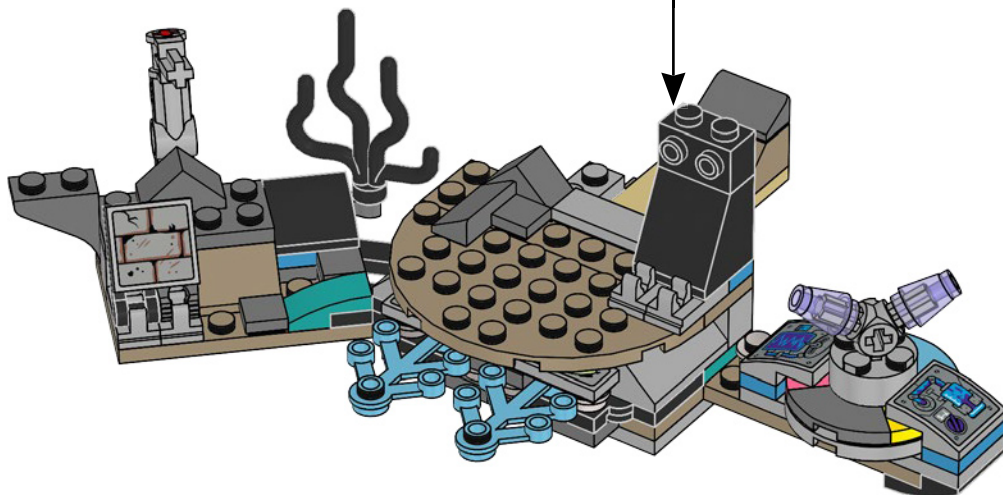
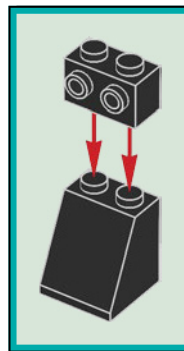

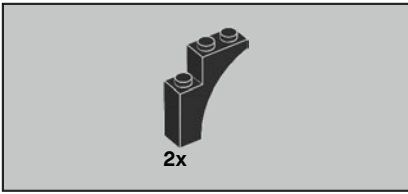

61

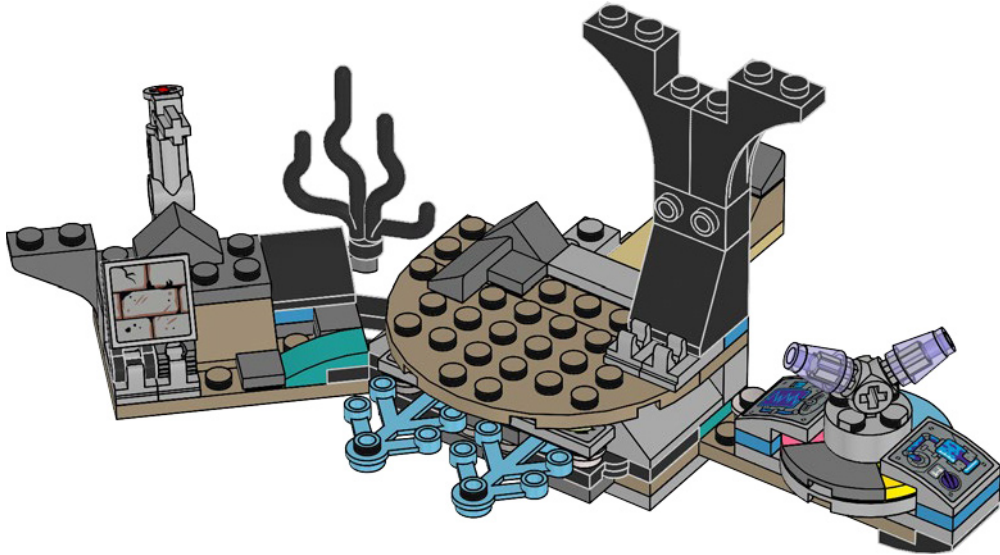



1x

62

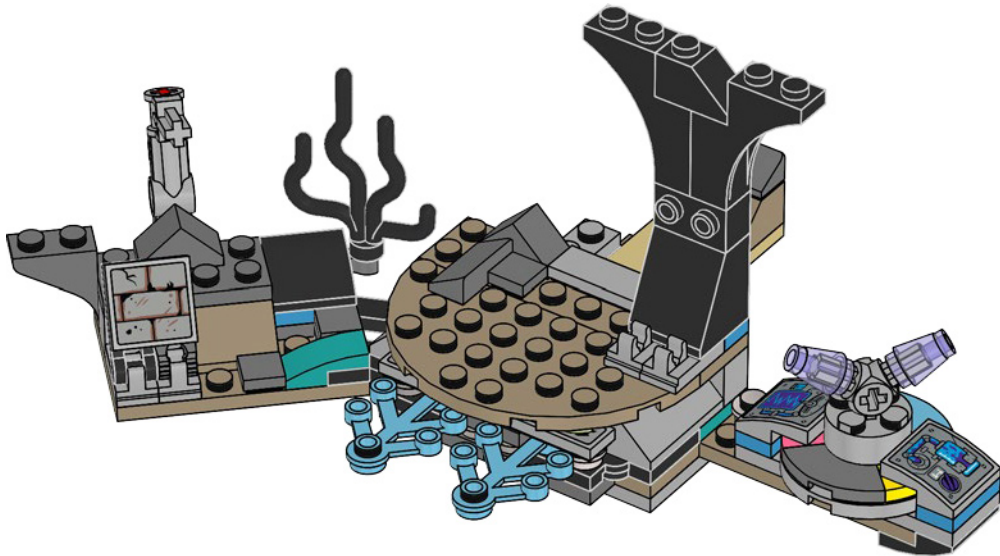

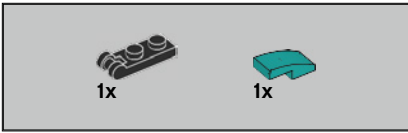

63

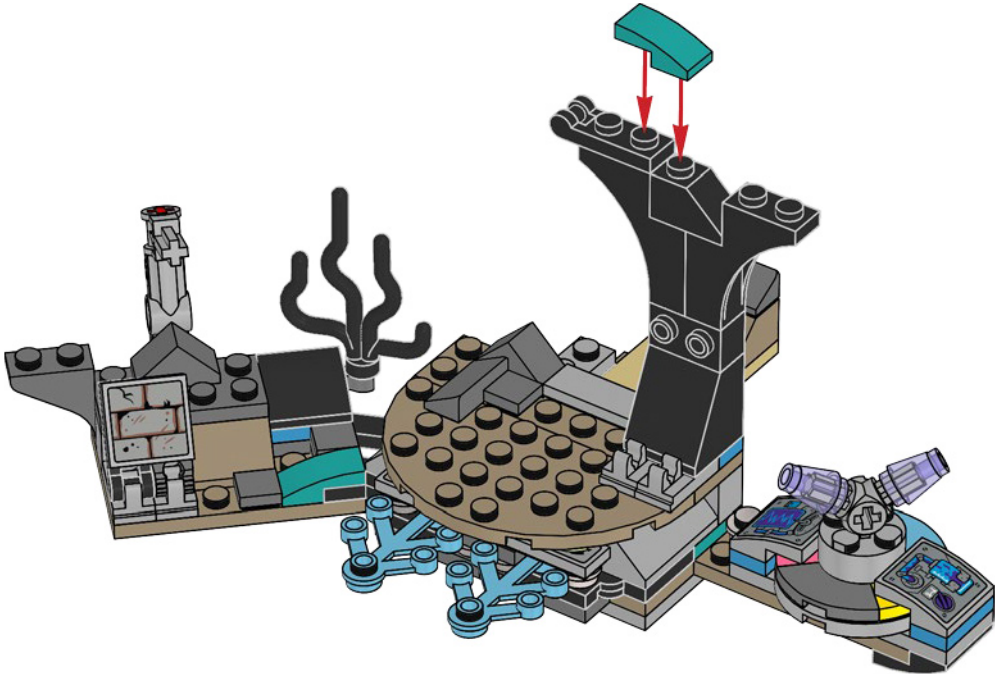

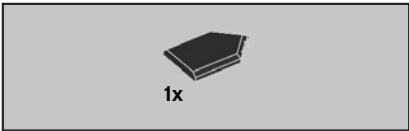

64

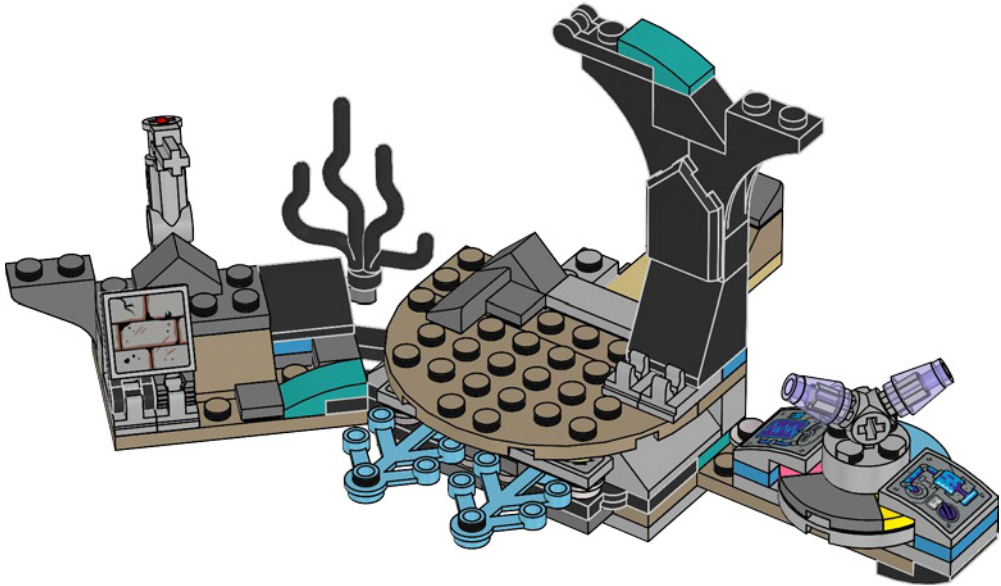

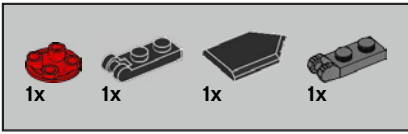

65

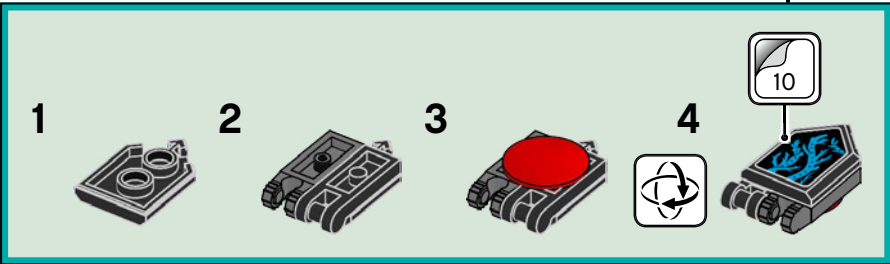
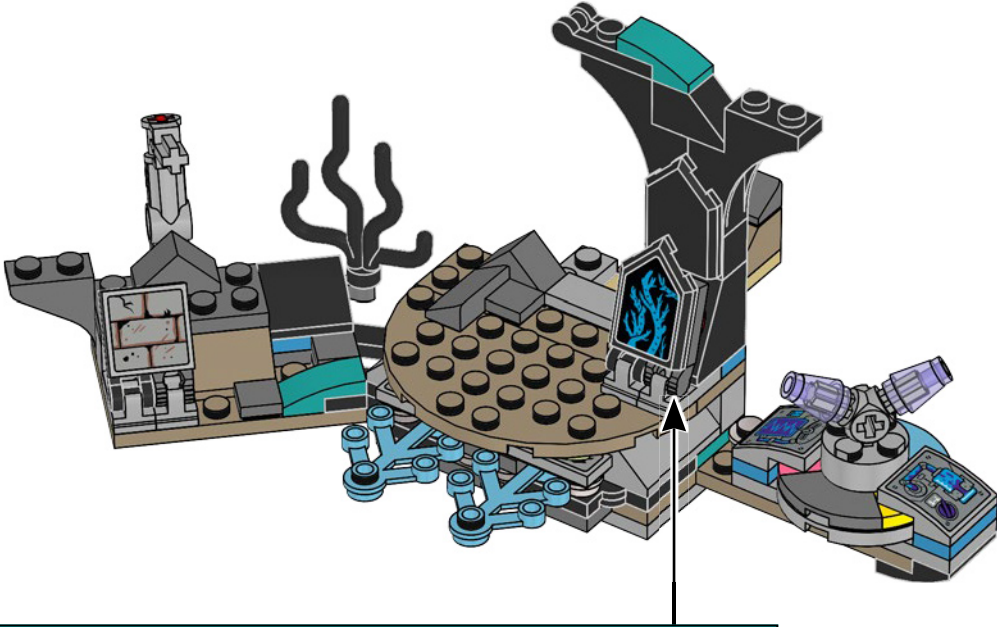



1x

66

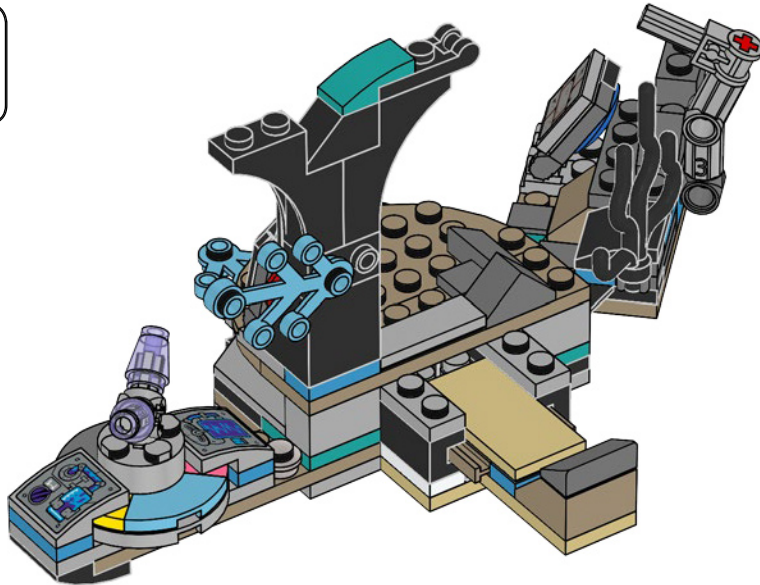

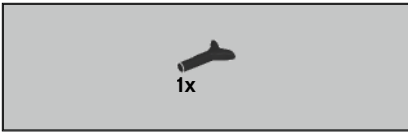

67

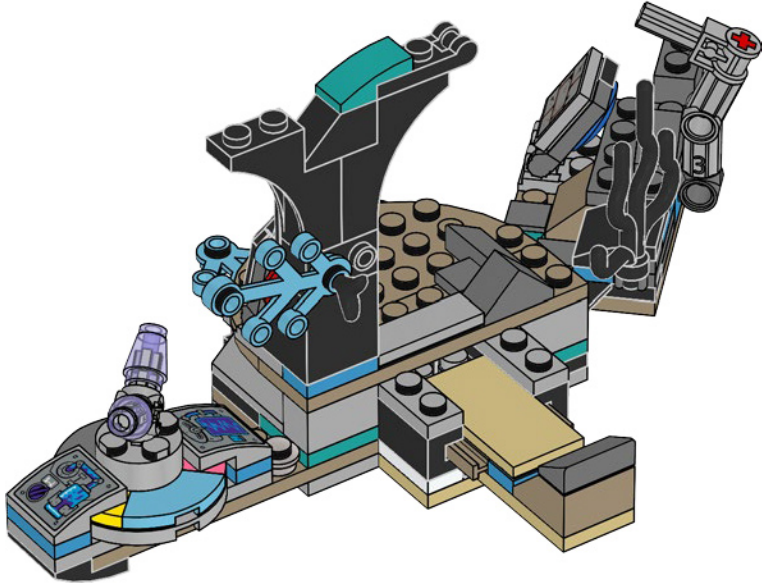

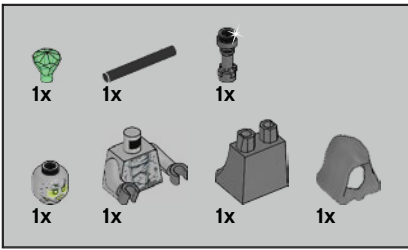

68

1

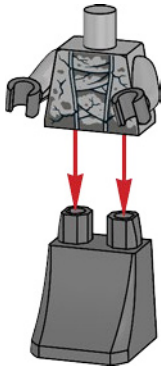

2



3

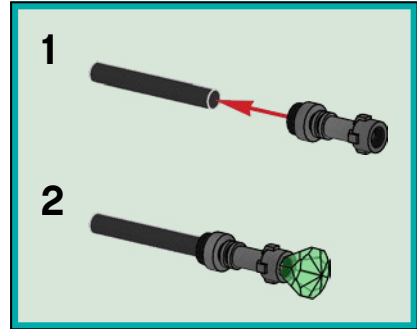

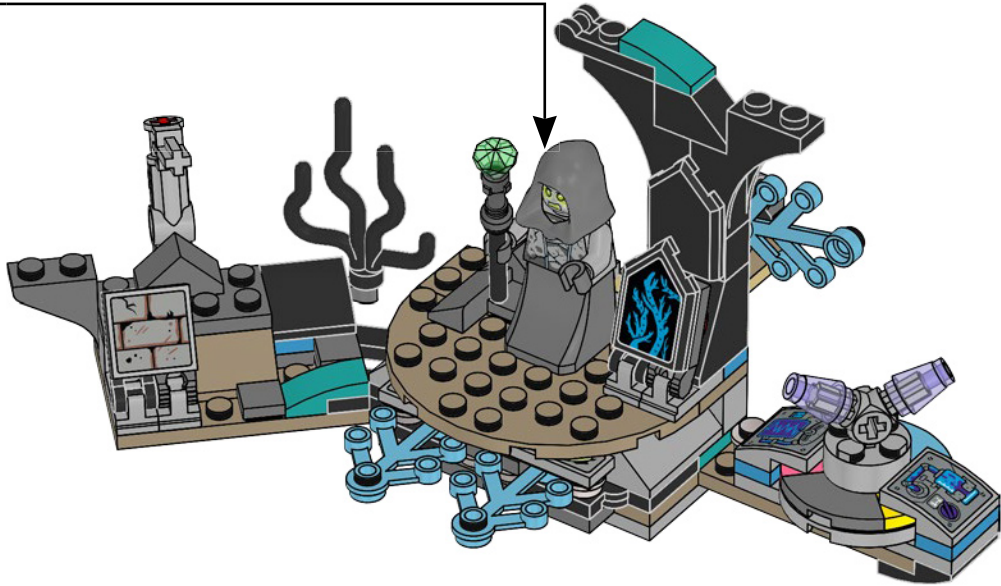



1x

69

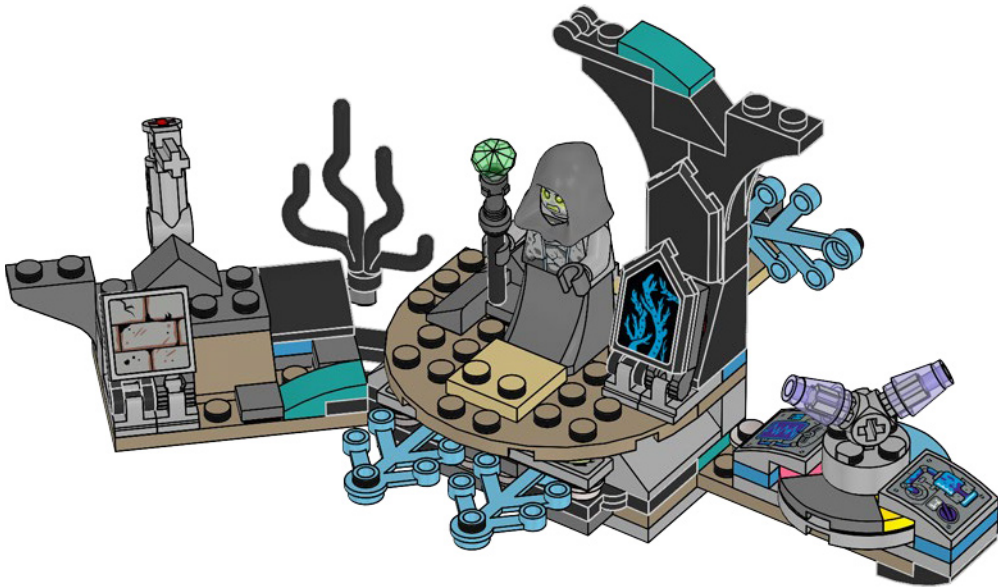

70

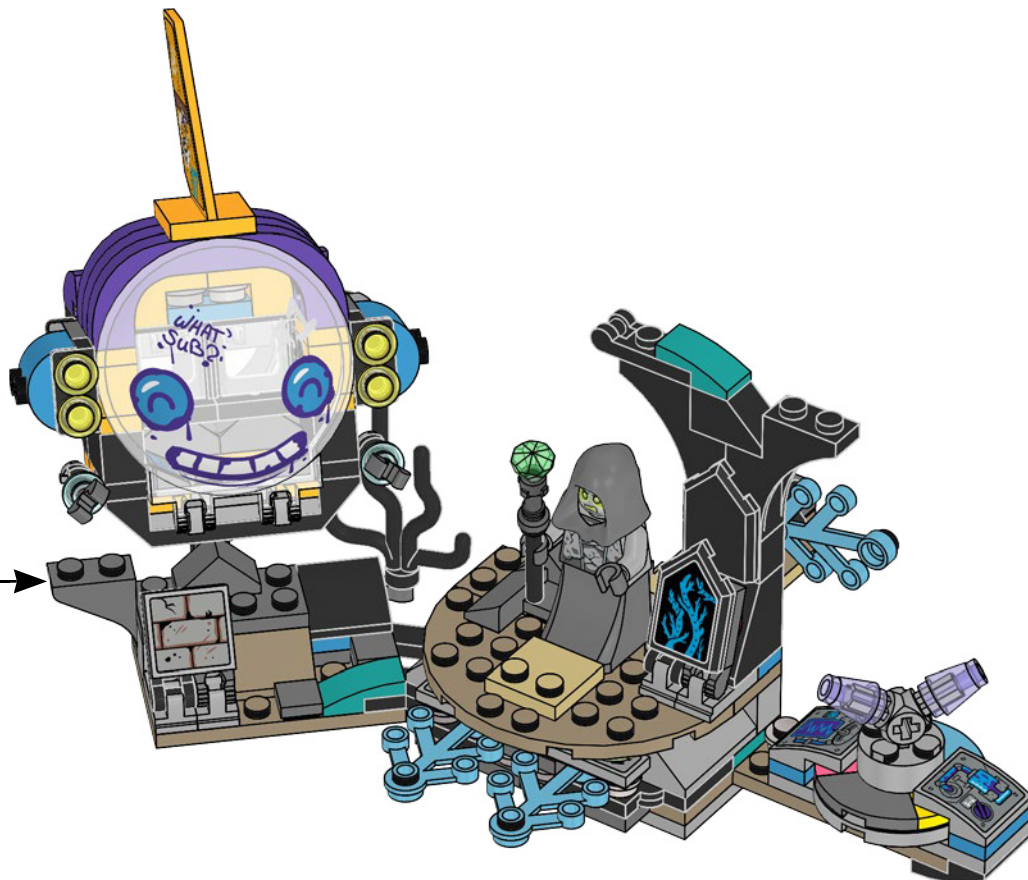



HIDDEN SIDE



70427



70428



70429



70432



70431



70430



HIDDEN SIDE



70433



70435



70434



70437



70436





1x
6238334



2x
371001



1x
6221467



2x
4114309



1x
6122047

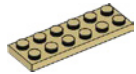

1x
4113993



2x
306221



2x
6284574



1x
4142865



1x
4278275



1x
4278276



1x
6289266



1x
6275508

62



2x
654126



1x
4253815



2x
4121715



1x
6272138



1x
6302216



1x
4121966



2x
306926



2x
4539128



2x
6020193



1x
604126



1x
6093525



1x
6211476



1x
6053077



1x
4273703



3x
4515368



2x
6245251



2x
362226



2x
6038531



2x
428726



1x
6295073



2x
6313116



2x
6172997



2x
265326



2x
6102782



1x
6054852



2x
663626



1x
4541984



2x
6254552



1x
6303511



4x
6173640



4x
6240216



1x
6247788



2x
6249427



3x
6249390



2x
4567340



1x
6302218



1x
6303513



1x
6306687



2x
4616711



2x
6184880



1x
6035540



1x
6167894



1x
6146989



2x
4246957



2x
6061685

6x
6028736

2x
6023185

2x
6099714

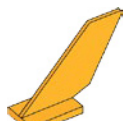
3x
6020074

1x
6307483

1x
6310281

1x
6309203

1x
6310346

1x
6309200

2x
4539481

1x
6302228

1x
4211526

1x
4211807

2x
4211541

2x
6305049

3x
4211388

4x
4598526

1x
4502595

3x
6212077

1x
4211413

2x
6102357

1x
4211536

1x
6261387

3x
4558169

2x
4211773

2x
6093058

1x
6276045

1x
4515351

2x
4211438

1x
4211407

3x
4210848

5x
6296892



2x
4226221

4x
4567887

1x
6005331

2x
4211088

1x
6122266

1x
6283991

2x
6284702



1x
4210635

2x
4218696

1x
6265306

2x
6267047

3x
4211133

1x
6186635

1x
6310368

2x
6278155

1x
4211065

1x
6302226

13x
4633691

1x
6122727

1x
6074417

1x
6303519

1x
6250024

8x
4653988

2x
6249815

2x
6307482

1x
6258069

3x
6307493

1x
6286505

2x
6103449

3x
6307486

Customer Service

Kundenservice

Service Consommateurs

Servicio Al Consumidor

LEGO.com/service or dial



: 00800 5346 5555

: 1-800-422-5346



WIN

GO TO [WWW.LEGO.COM/PRODUCTFEEDBACK](http://www.LEGO.COM/PRODUCTFEEDBACK) AND
GIVE US YOUR SHORT **FEEDBACK** ABOUT THIS
LEGO® SET FOR A CHANCE TO WIN
A COOL LEGO PRIZE.

Terms & Conditions apply

LEGO.com/productfeedback

GEWINNE

Erzähle uns auf
www.LEGO.com/productfeedback

etwas über die Erfahrungen, die du mit
diesem LEGO® Set gemacht hast, und
sichere dir die Chance auf einen coolen
LEGO Preis!

Es gelten die Teilnahmebedingungen

GAGNE

Rends-toi sur
www.LEGO.com/productfeedback

et donne-nous quelques commentaires
sur ce produit LEGO® pour avoir une
chance de gagner un prix LEGO !

Voir Conditions Générales

GANANA

Visita
www.LEGO.com/productfeedback

y envíanos tu opinión acerca de este set
LEGO®. ¡Participarás en el sorteo de un
premio LEGO!

Términos y Condiciones aplicables

获取奖品

登录
www.LEGO.com/productfeedback

给出关于此乐高®套装的简短反馈，
就有机会获得炫酷乐高奖品

《条款及条件》适用

LEGO, the LEGO logo and the HIDDEN SIDE logo are trademarks of the LEGO Group. ©2020 The LEGO Group.

6325303