

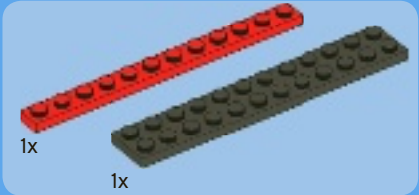

10220

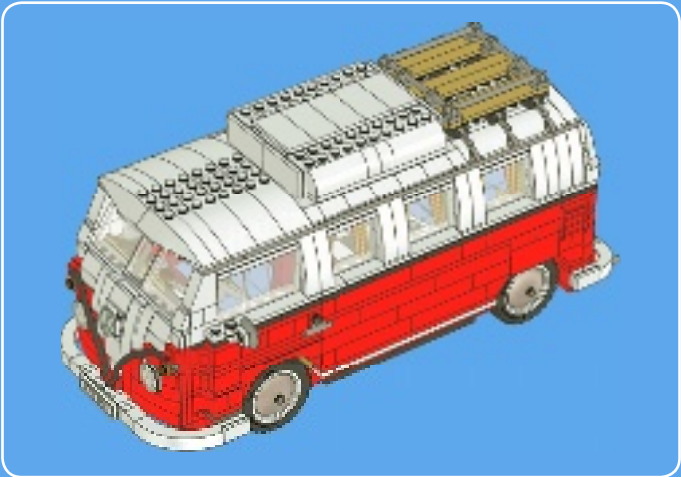



1

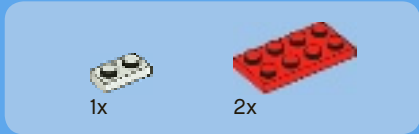
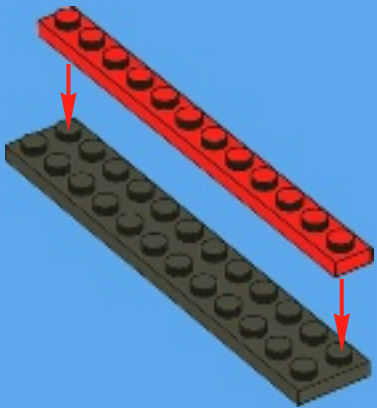

2

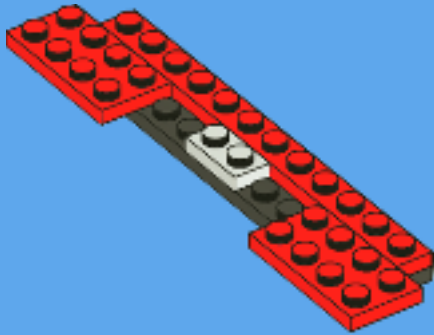

3

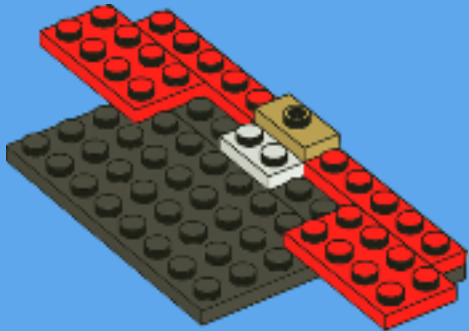

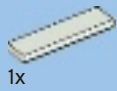

1x



2x



2x



1x

4

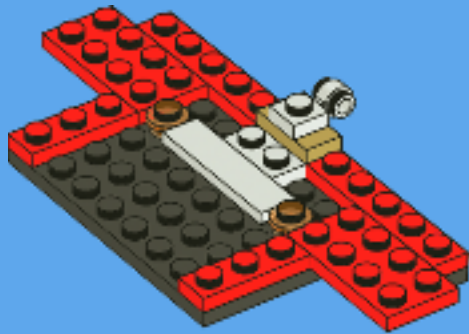

2x



1x



2x

5

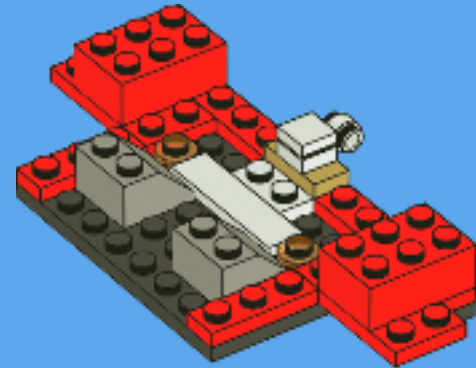

1x



4x

6

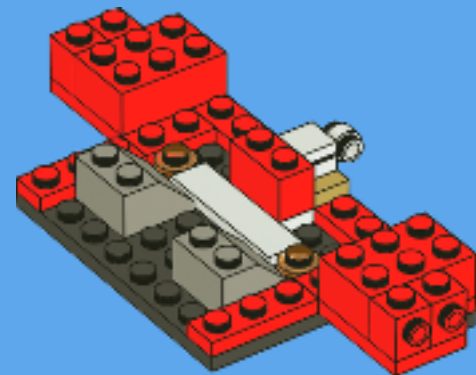

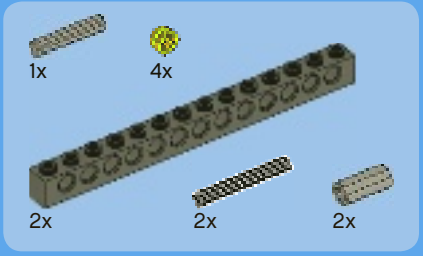

7

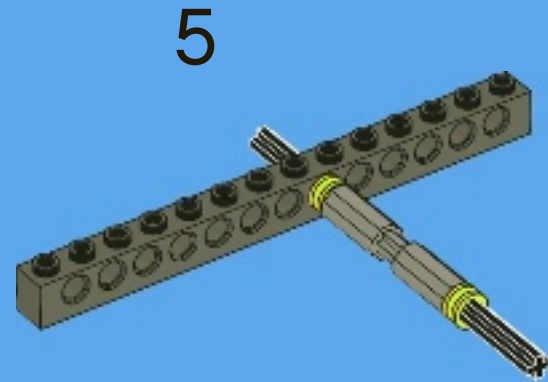
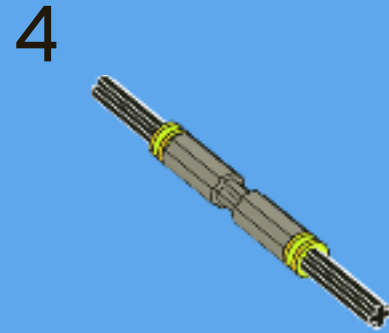
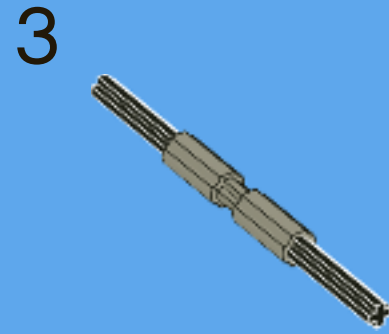
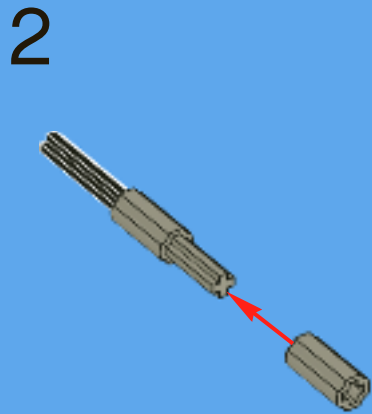
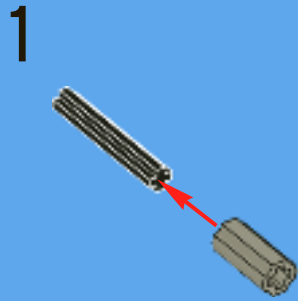

6

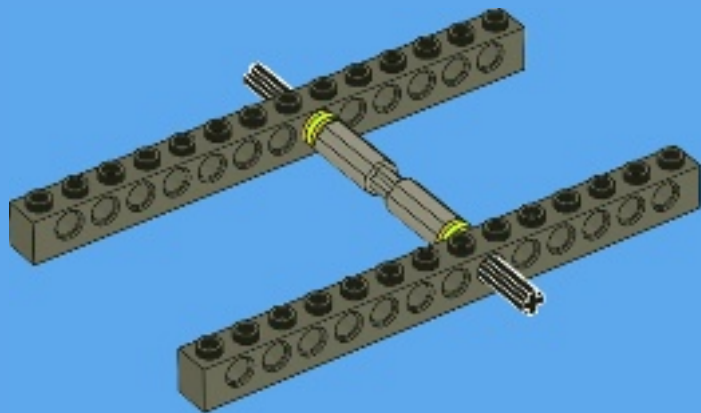

7

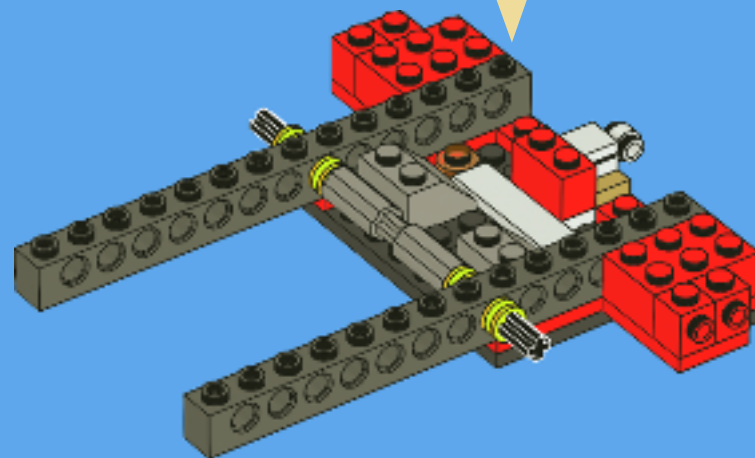
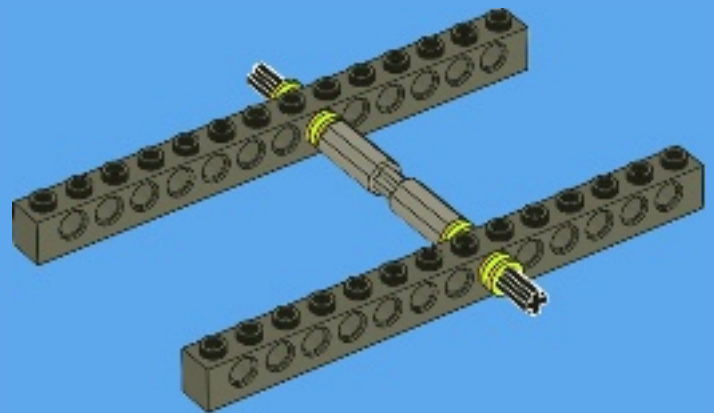



1x



2x

8

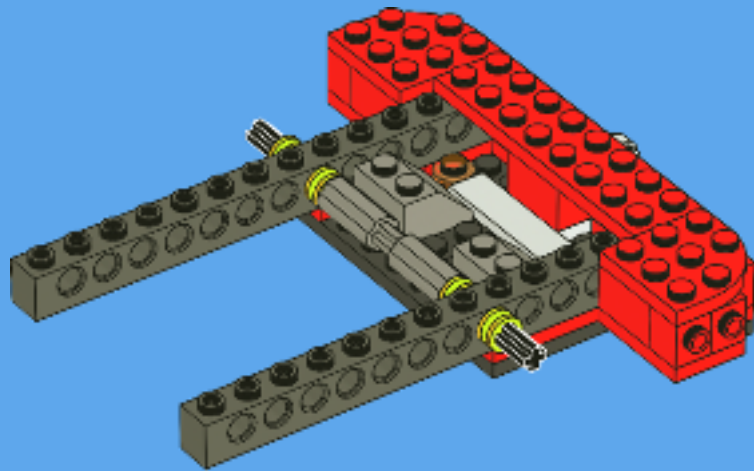

2x



2x



4x

9

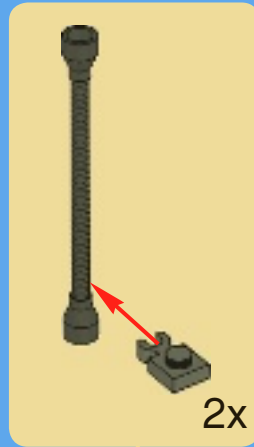

2x

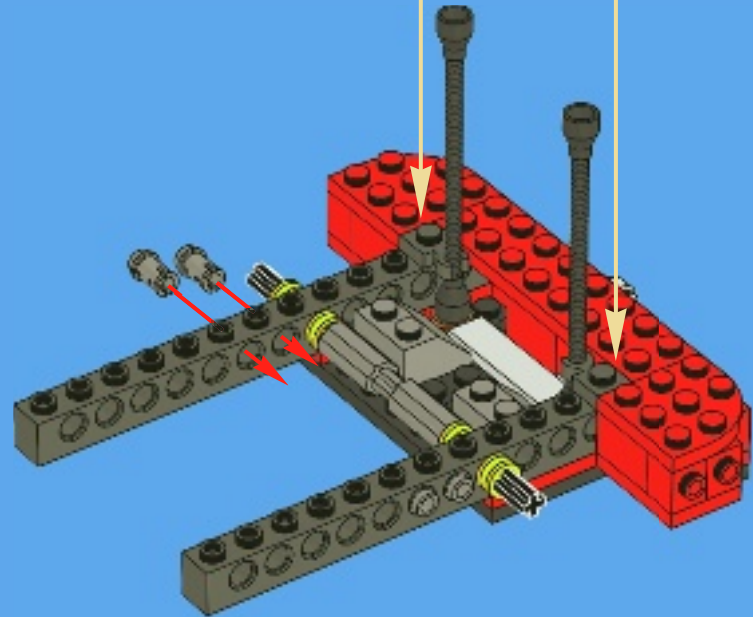



1

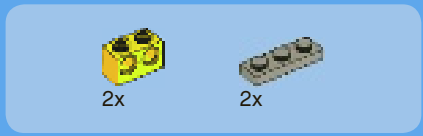
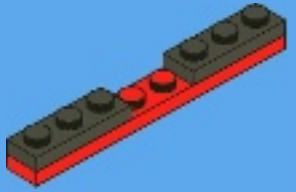

2

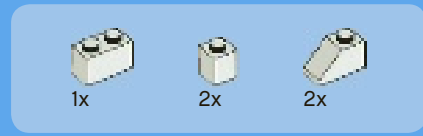
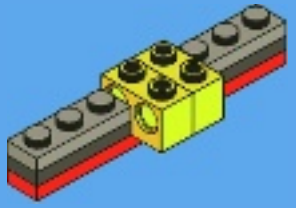

3

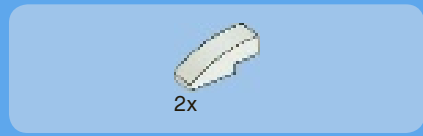
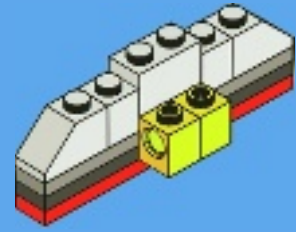

4

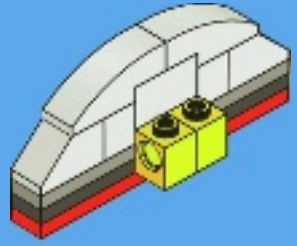



2x

5

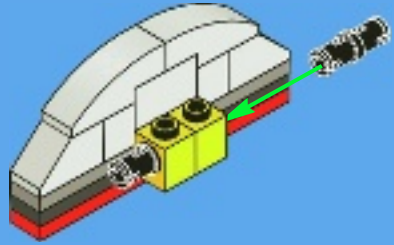

2x



2x

6

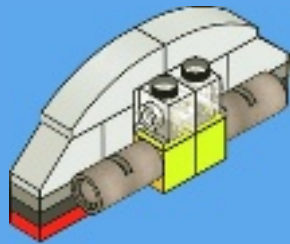

10

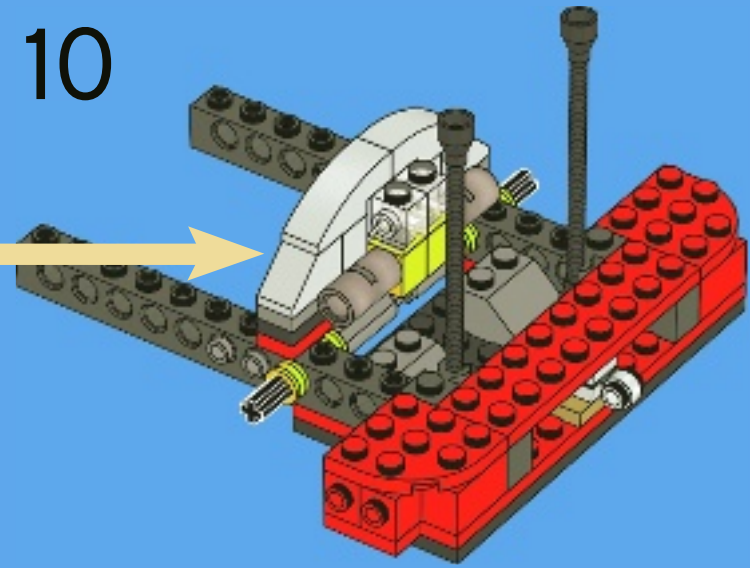

11

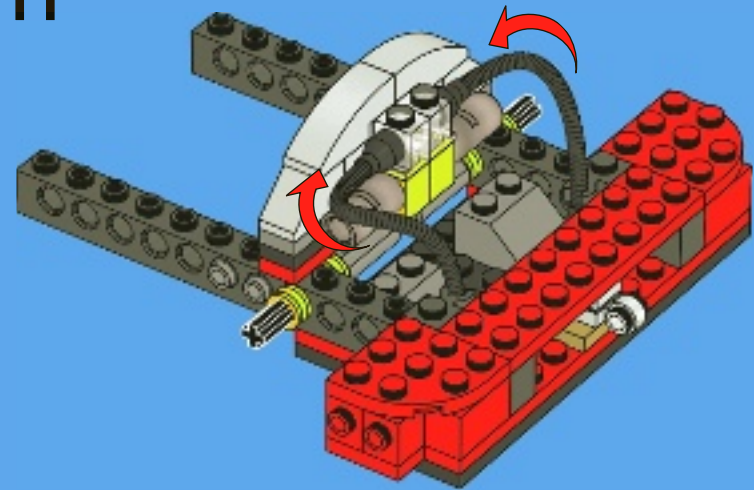



1x



1x

1

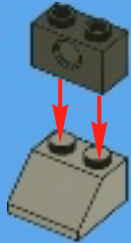

1x



1x



1x

2

1



2



1x



1x

3



1x



1x



1x



1x



2x

4

1



2

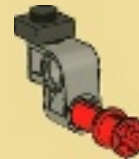

3

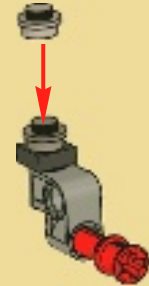



1x



1x

5

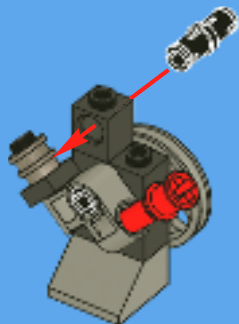

1x



2x

6



1x



1x

7

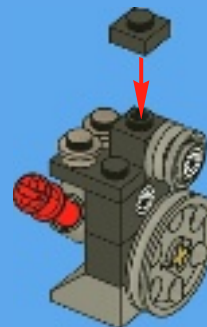

1x

8

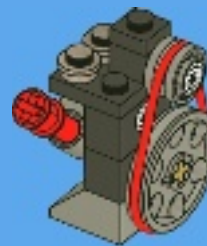

12

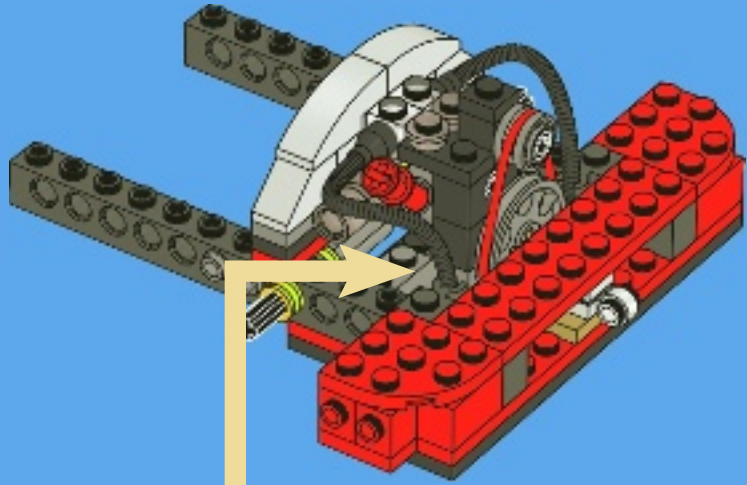

13

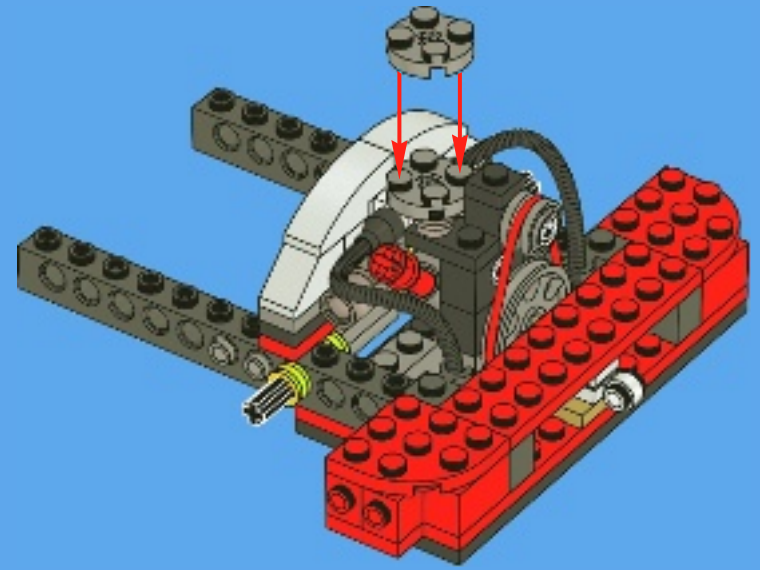

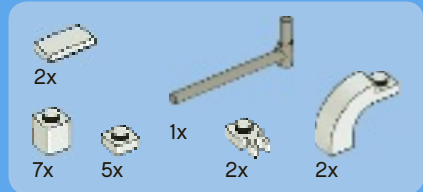

14

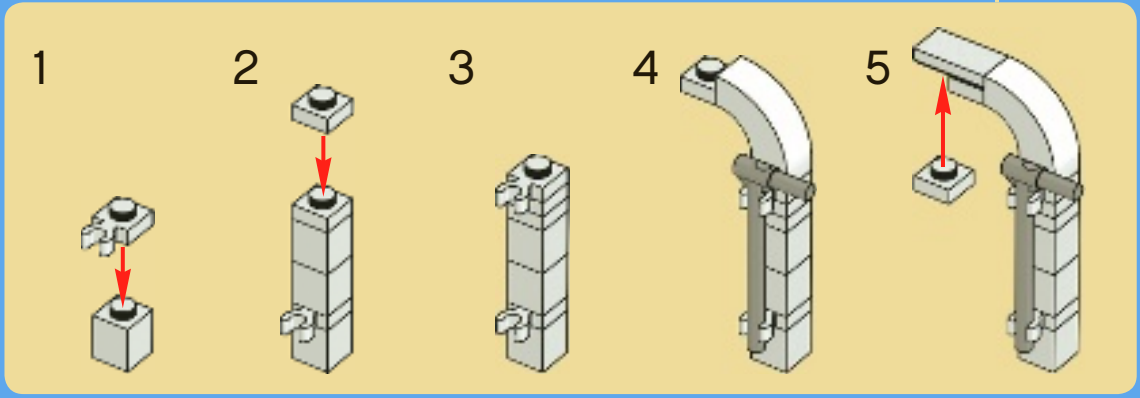
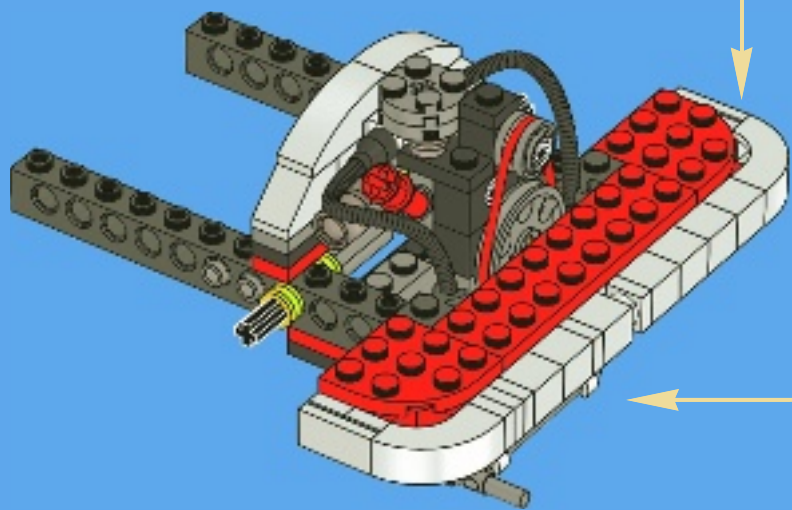
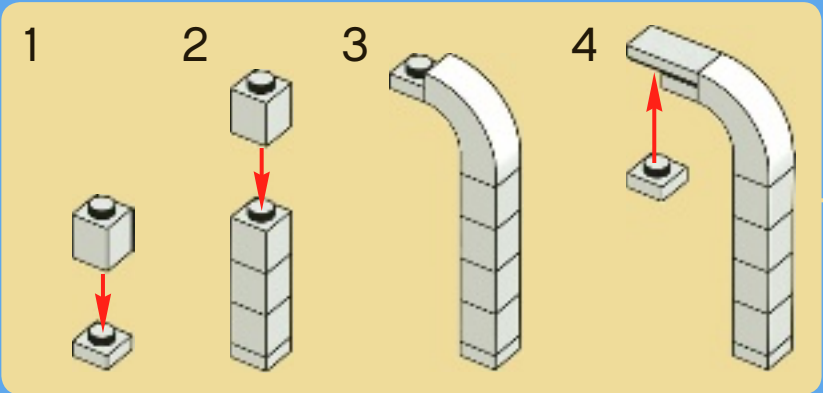

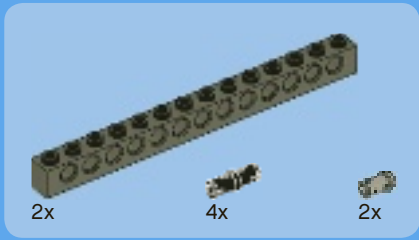

15

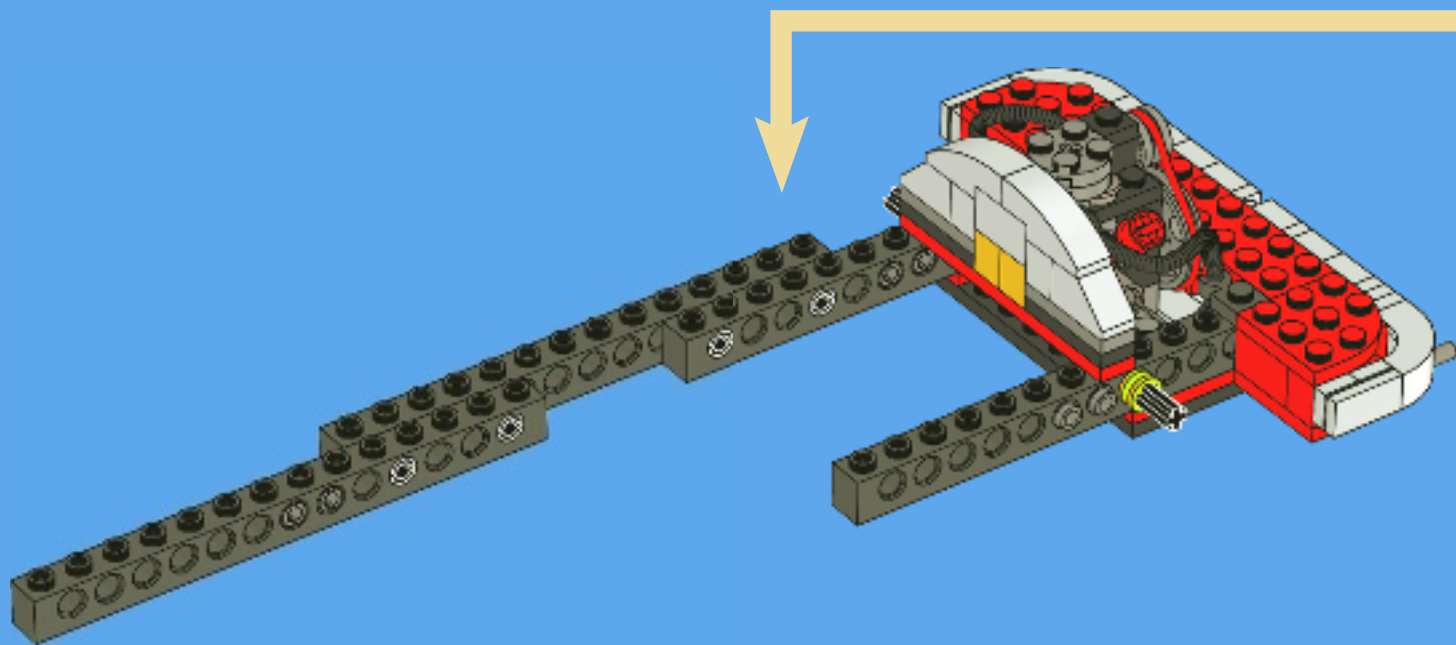
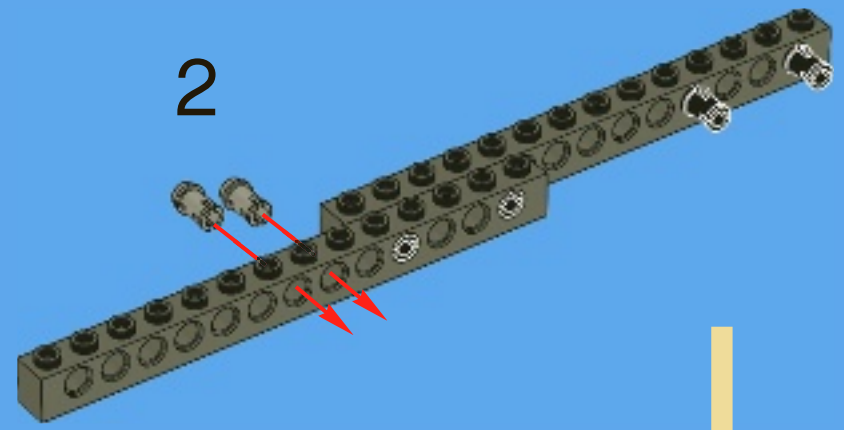



16

1

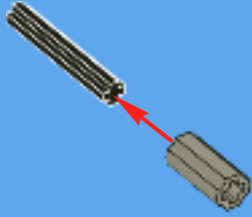

2

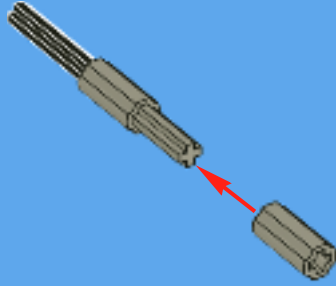

3

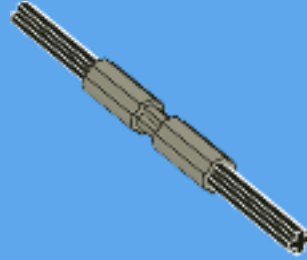

4

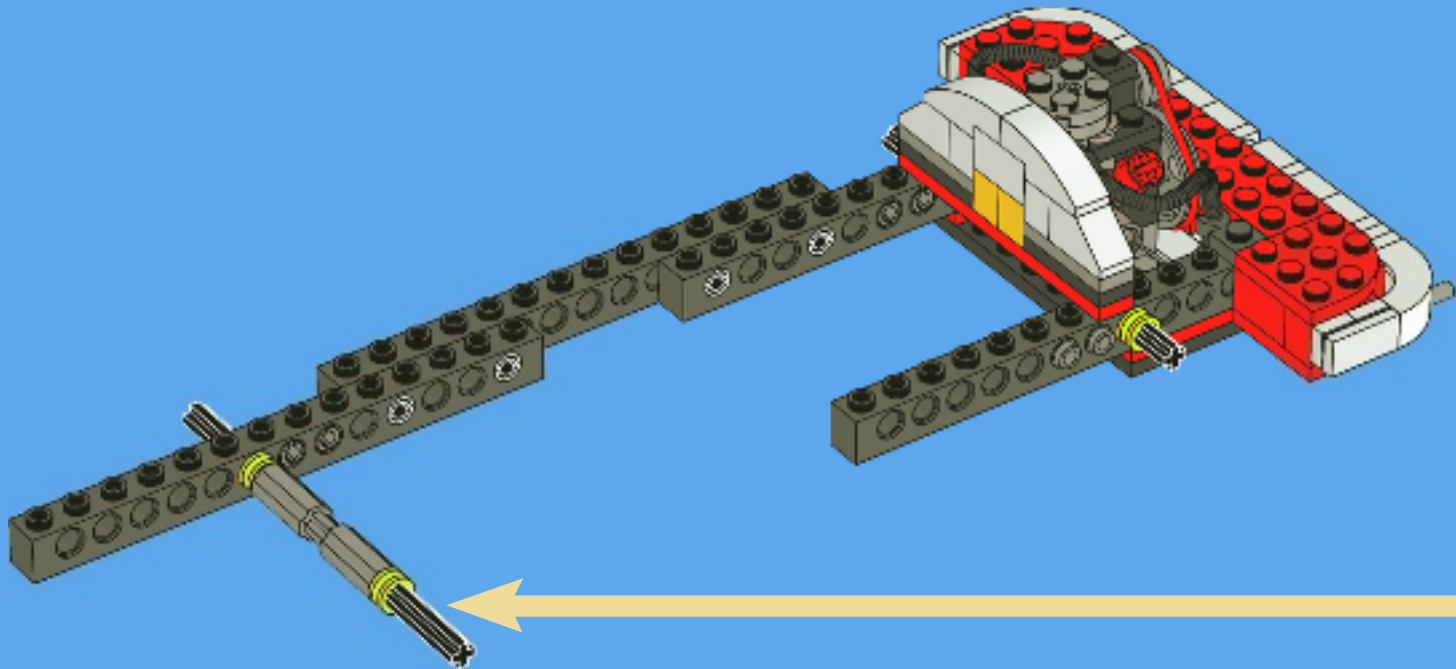
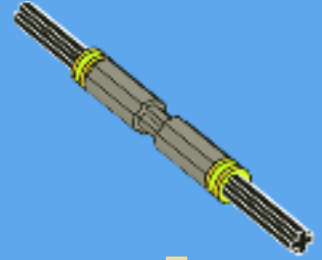

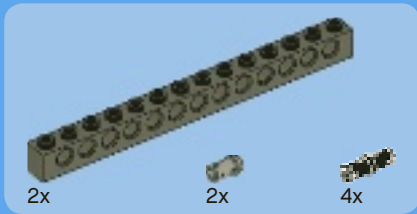

17

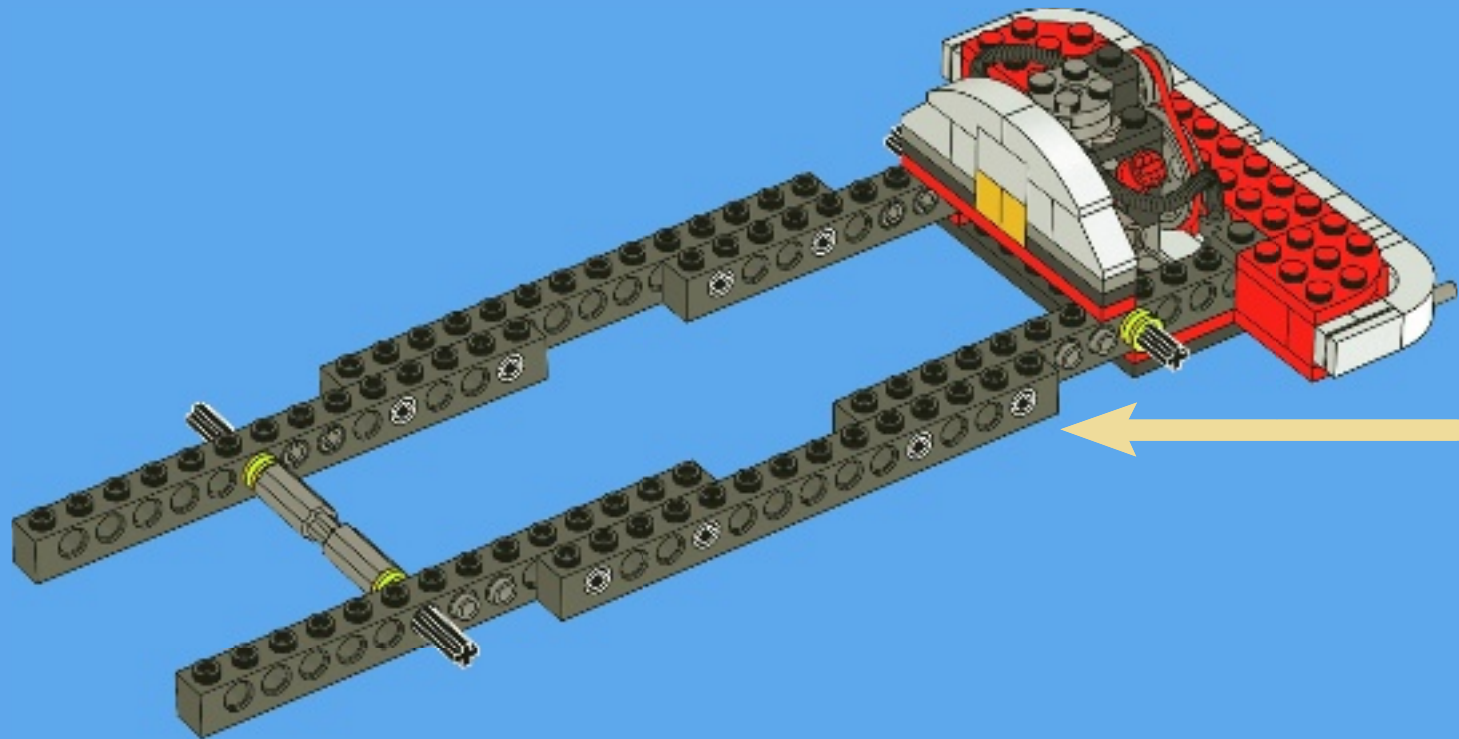
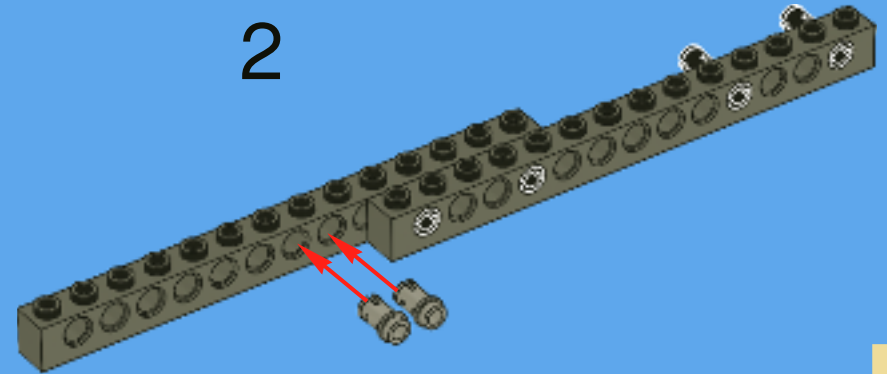
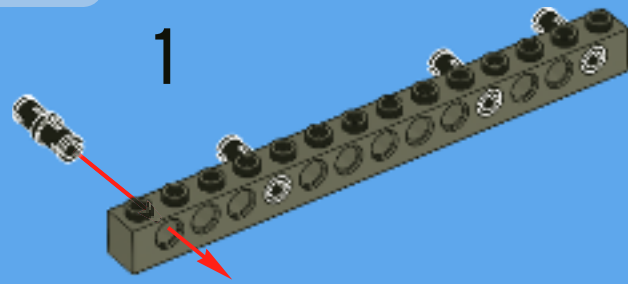



2x

18

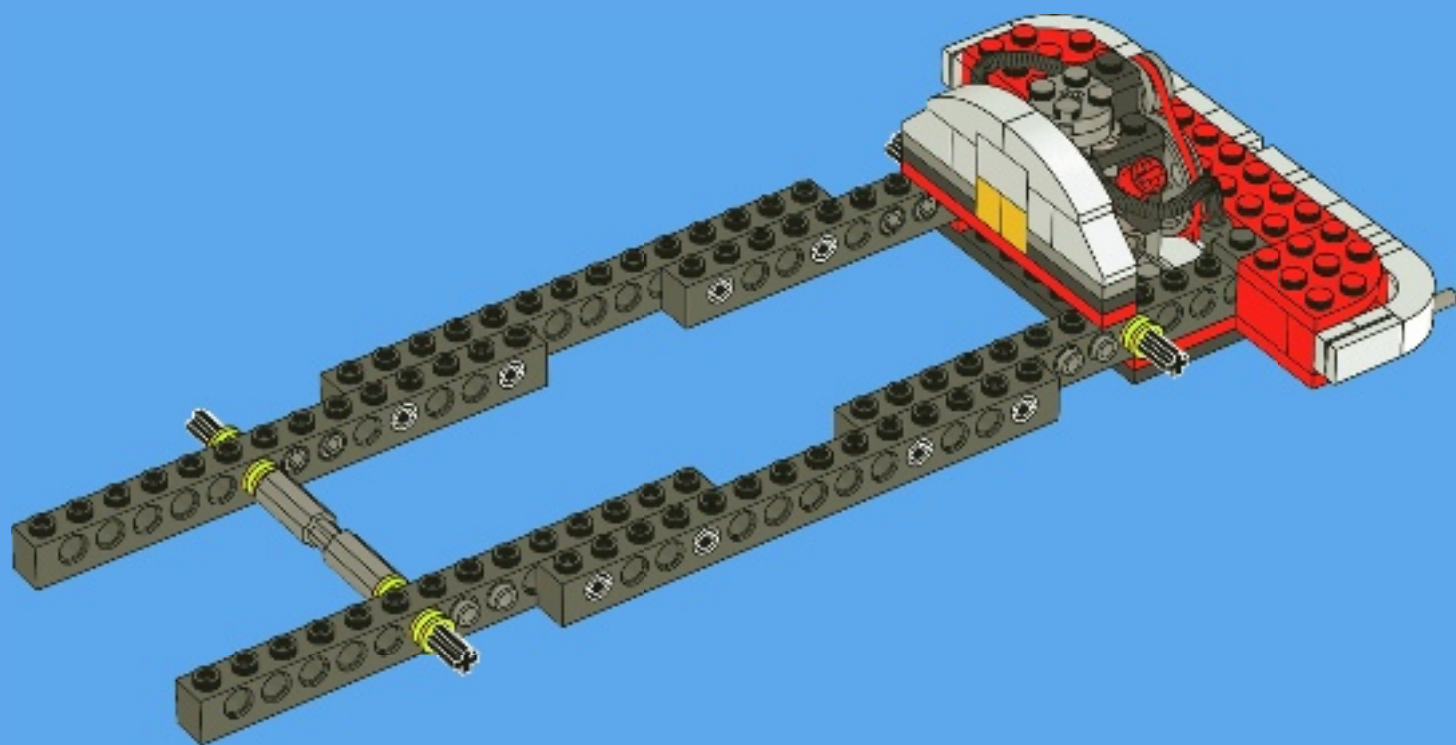

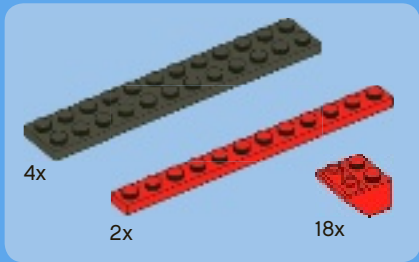

19

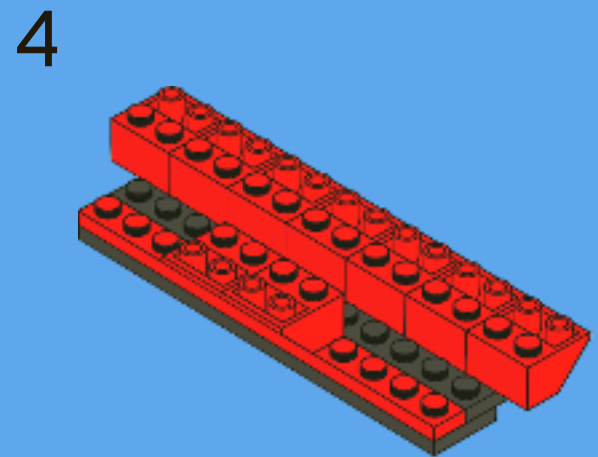
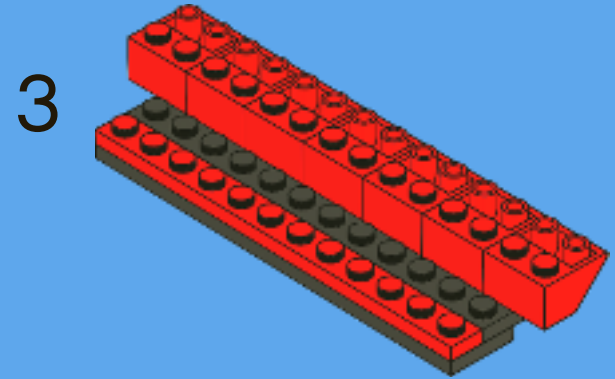
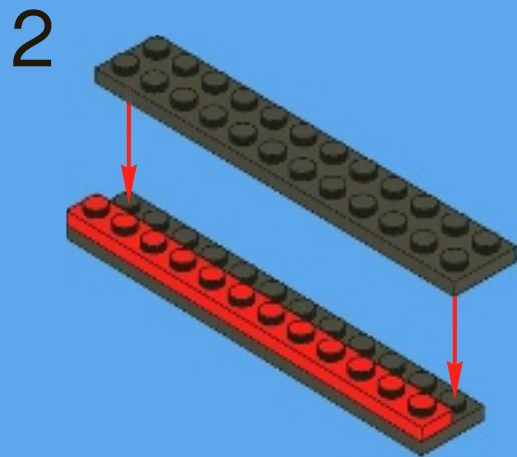
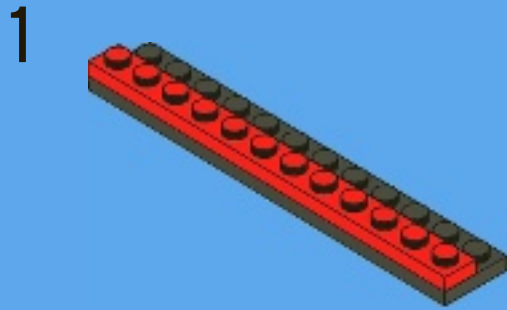

2x

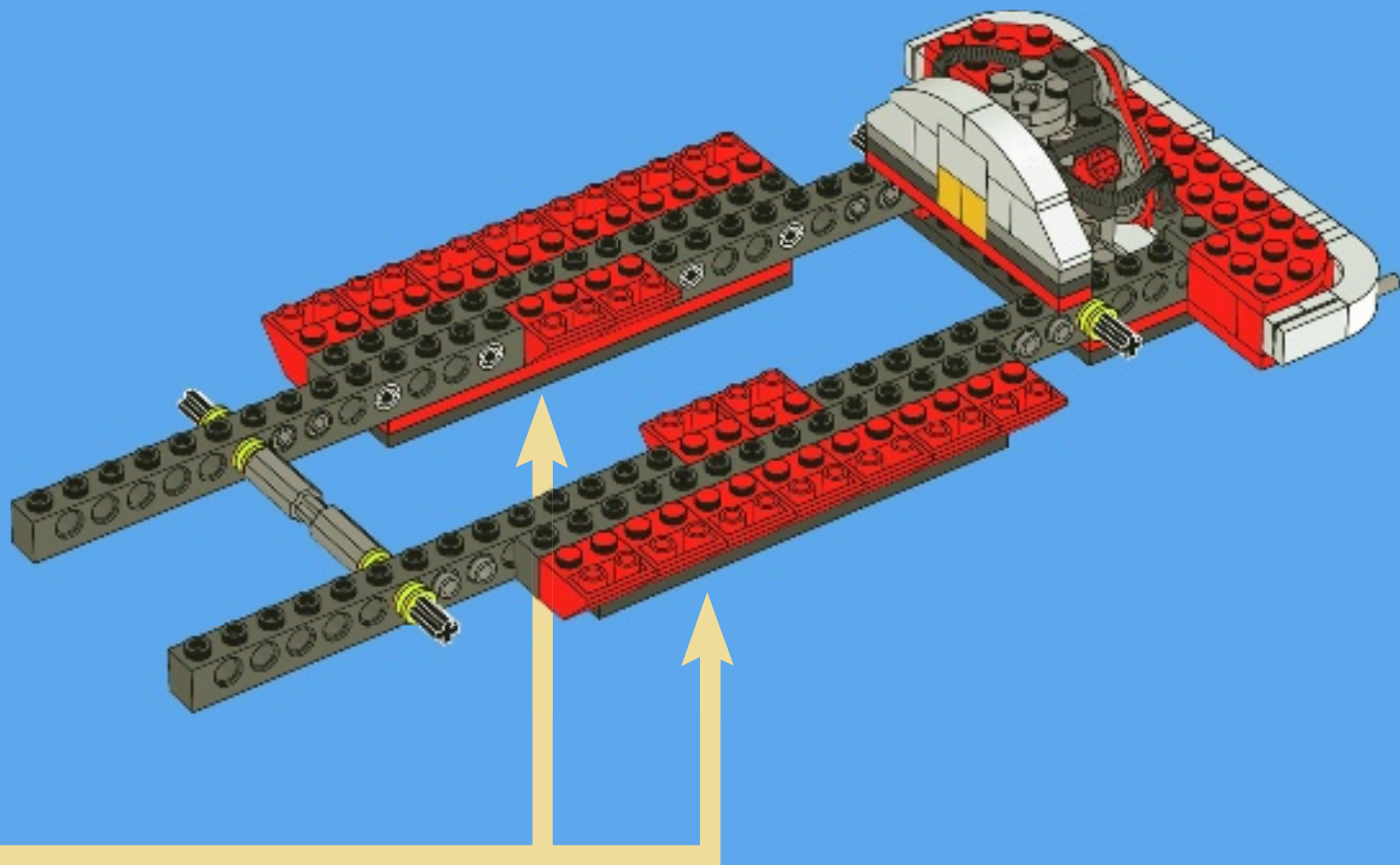



3x

20

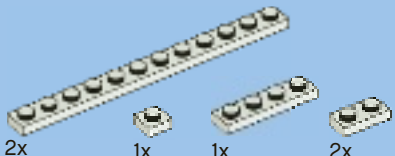
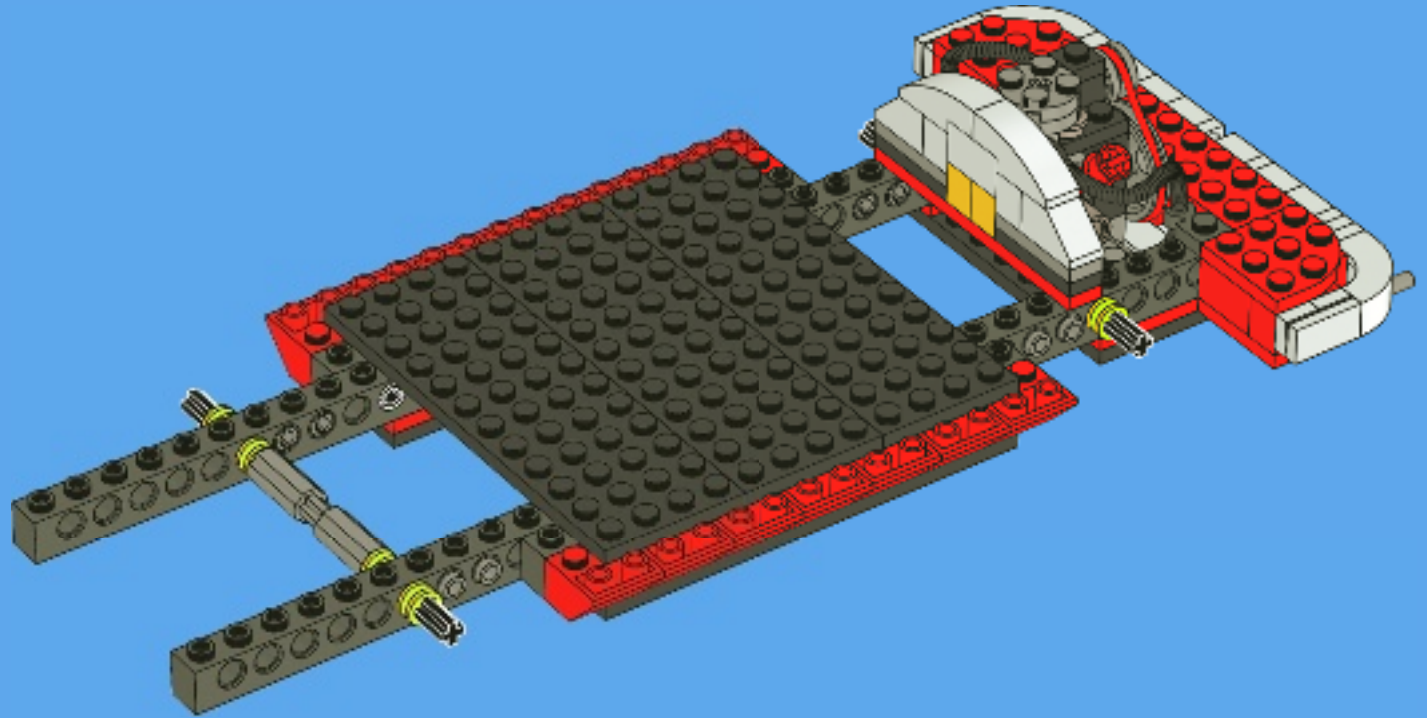

2x

1x

1x

2x

21

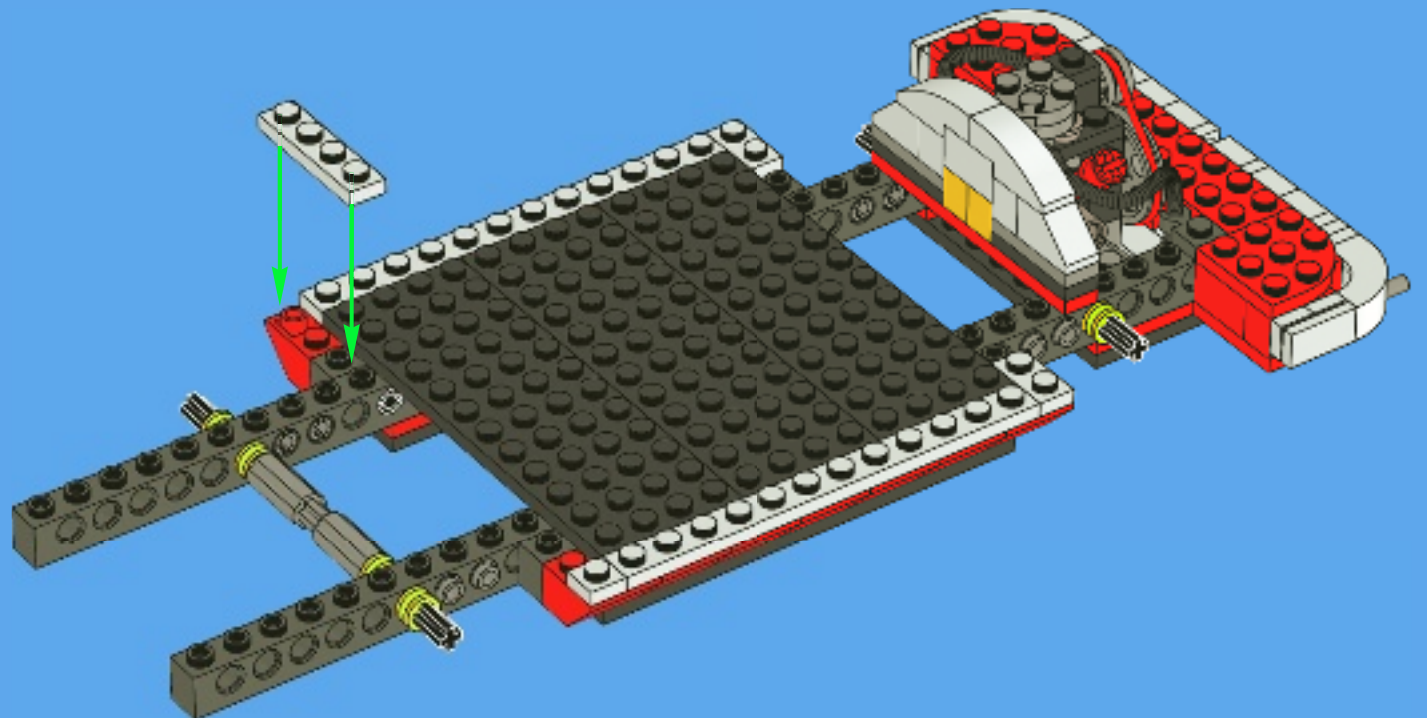

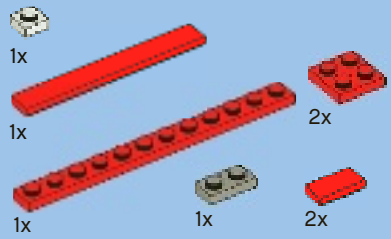

22

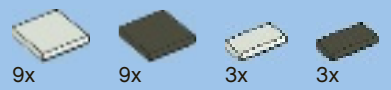
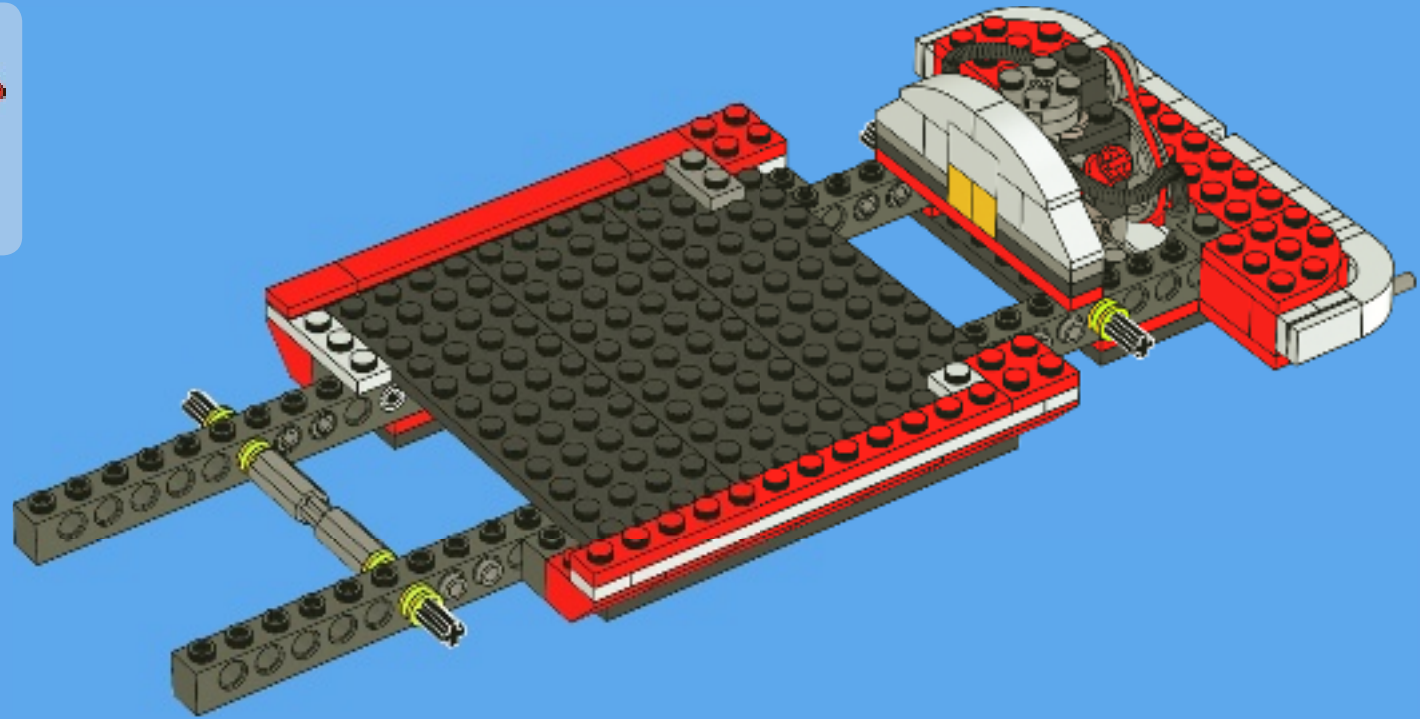

23

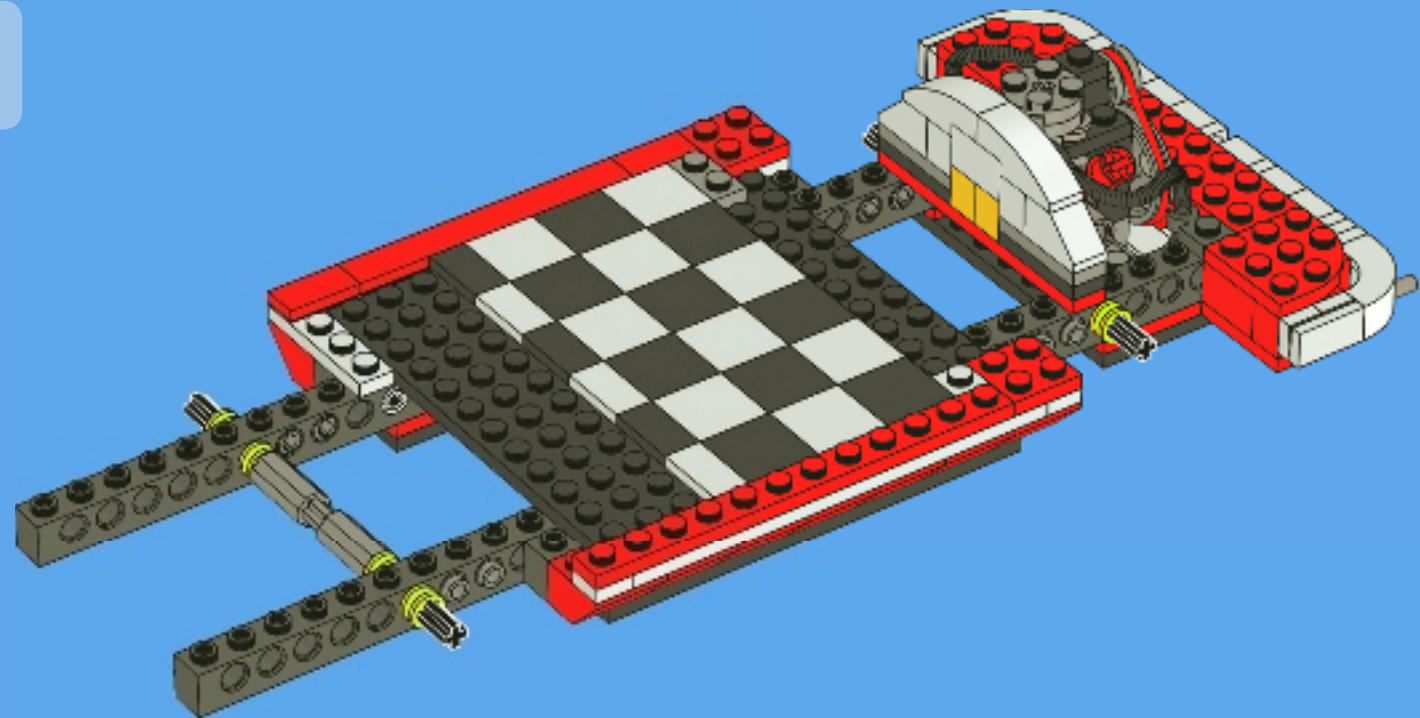

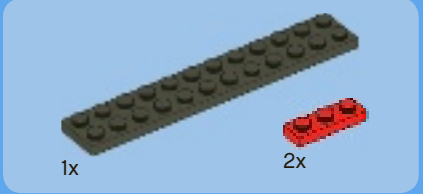

1



2

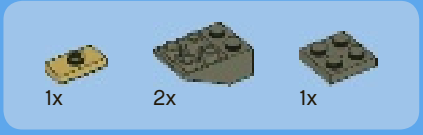

3

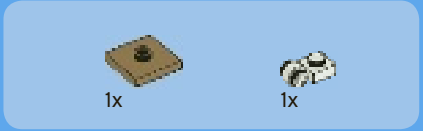
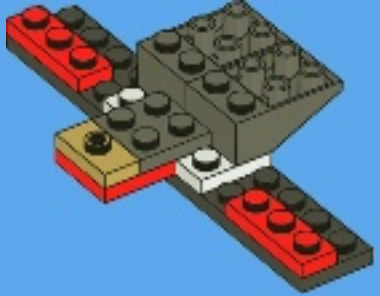

4

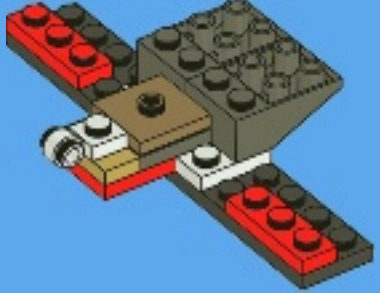



2x



4x

5

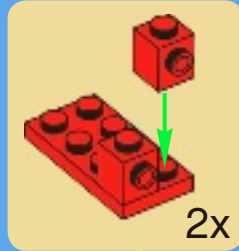

2x

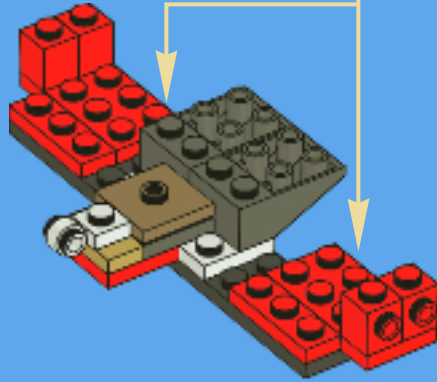

4x



1x

6

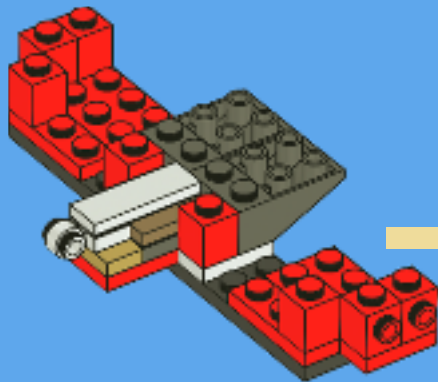

24

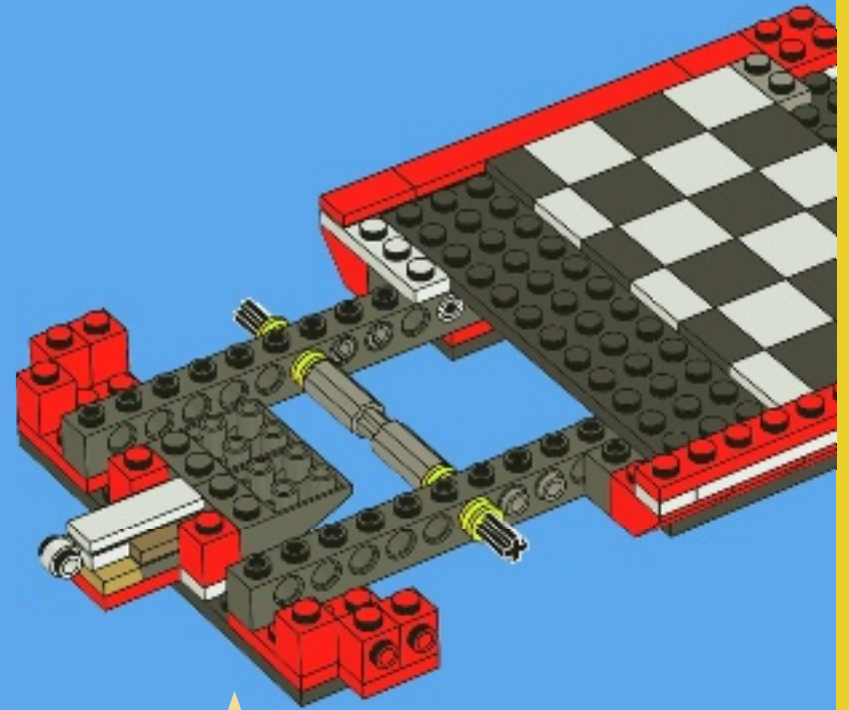

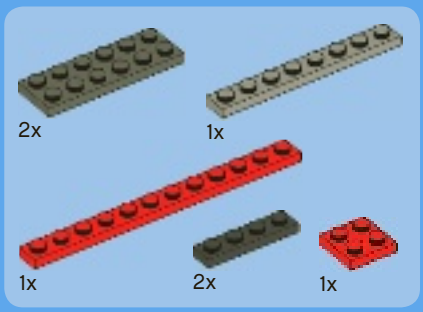

25

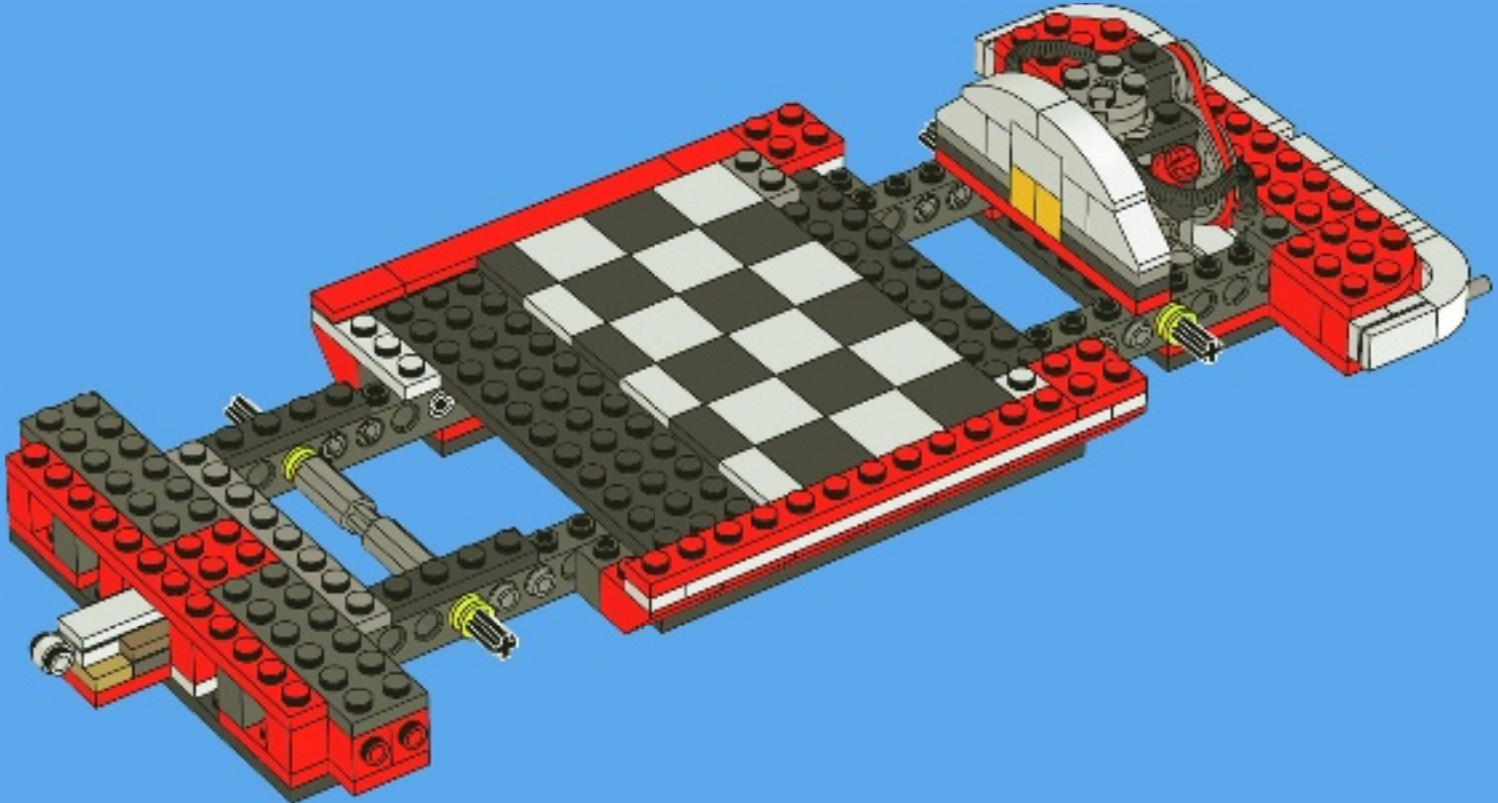

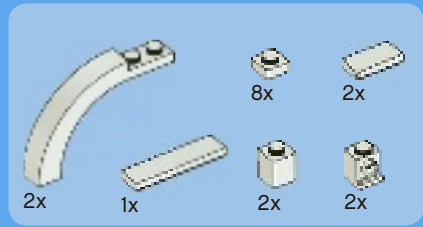

26

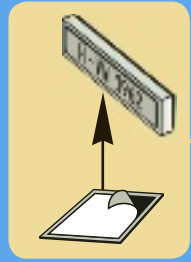
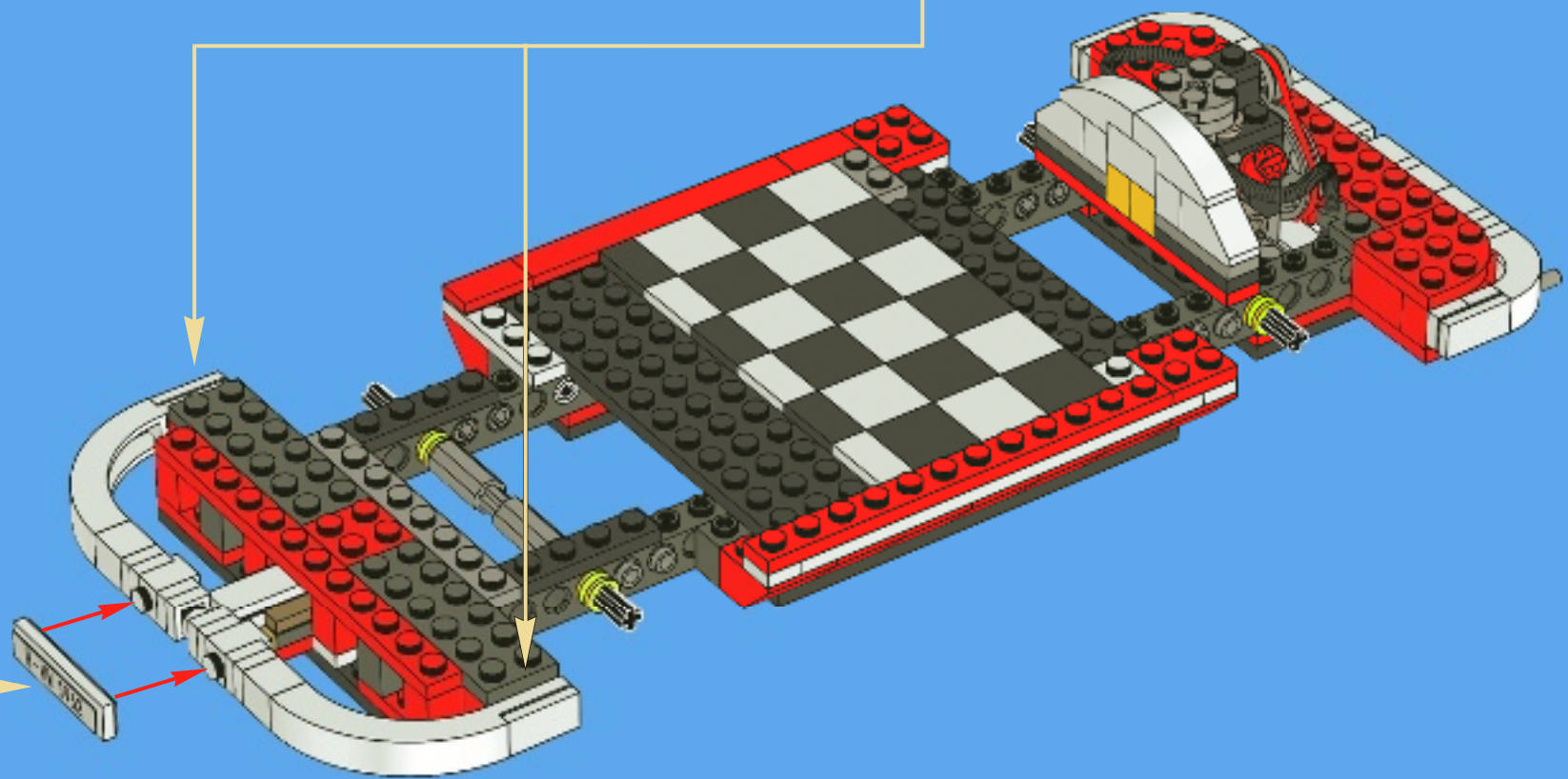
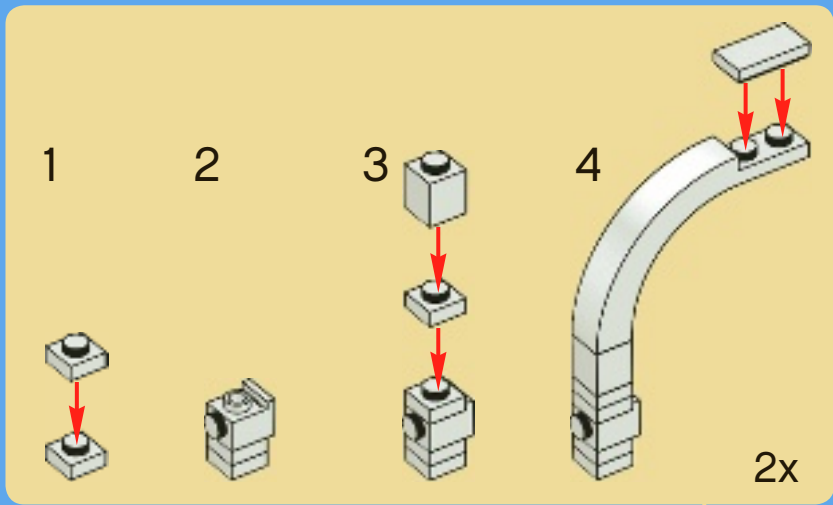

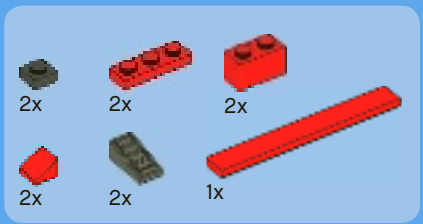

27

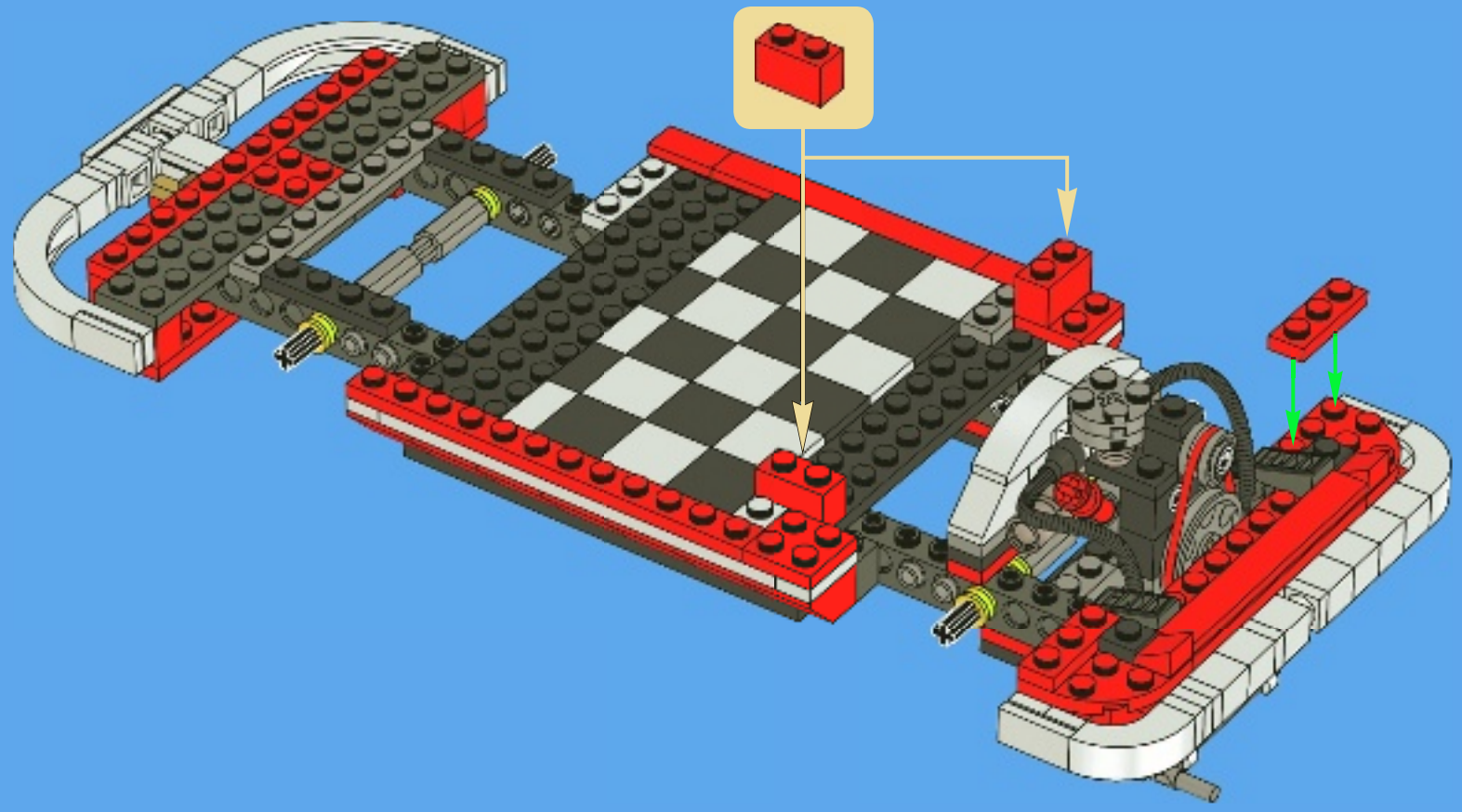

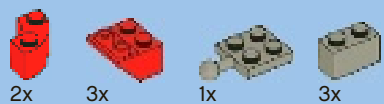

28

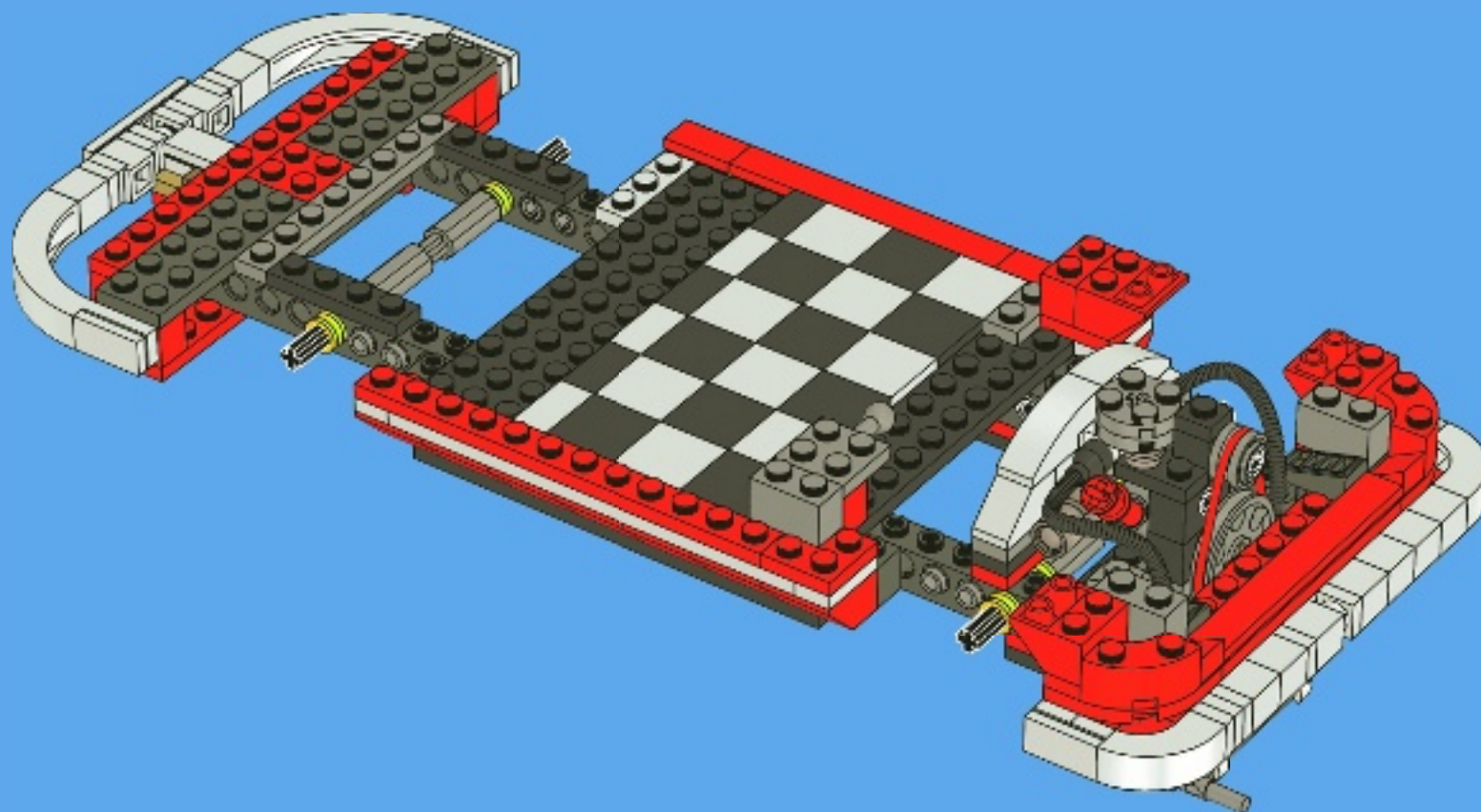

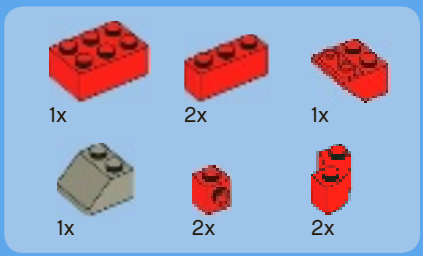

29

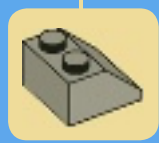
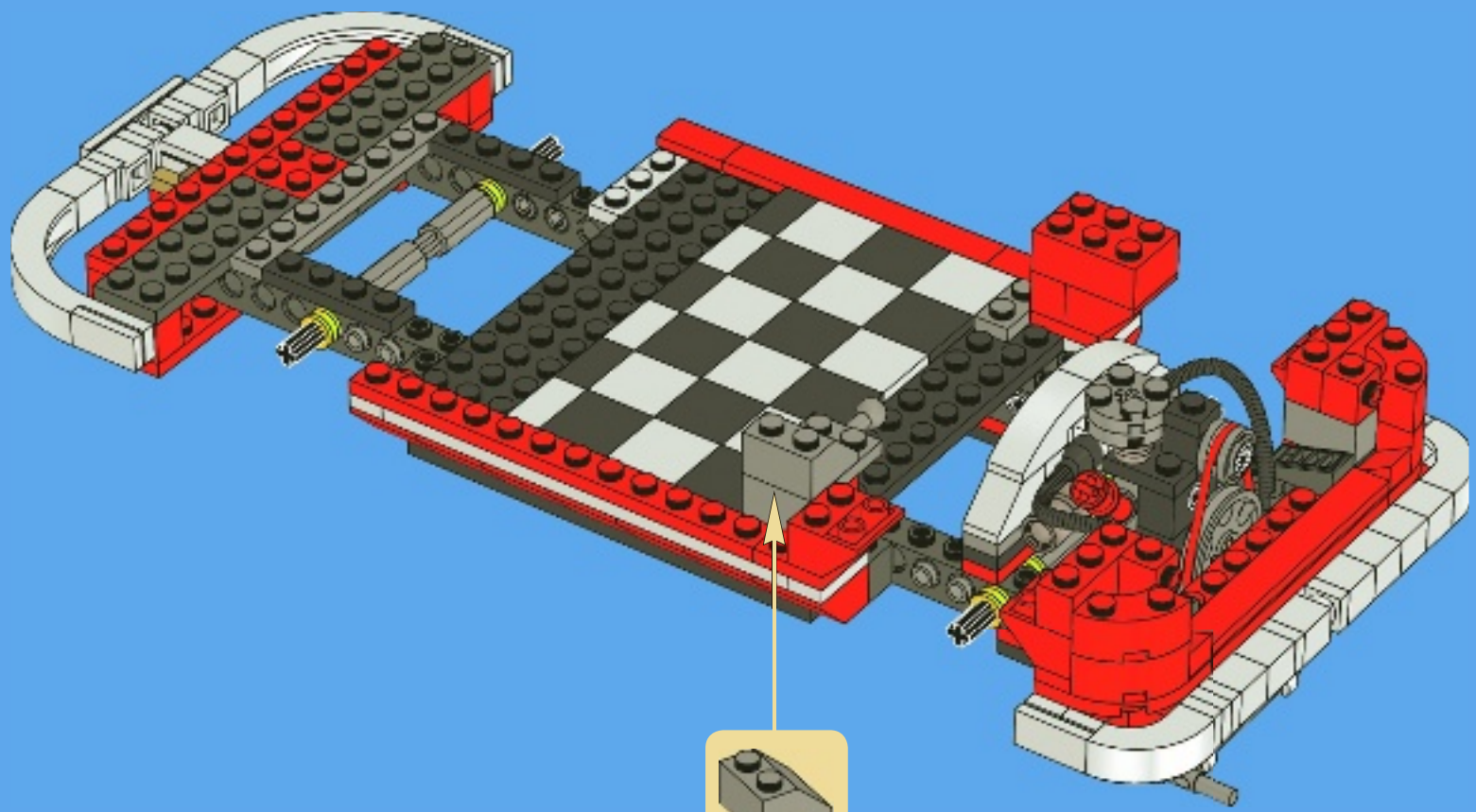

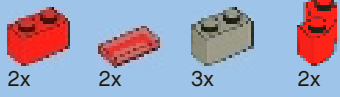

30

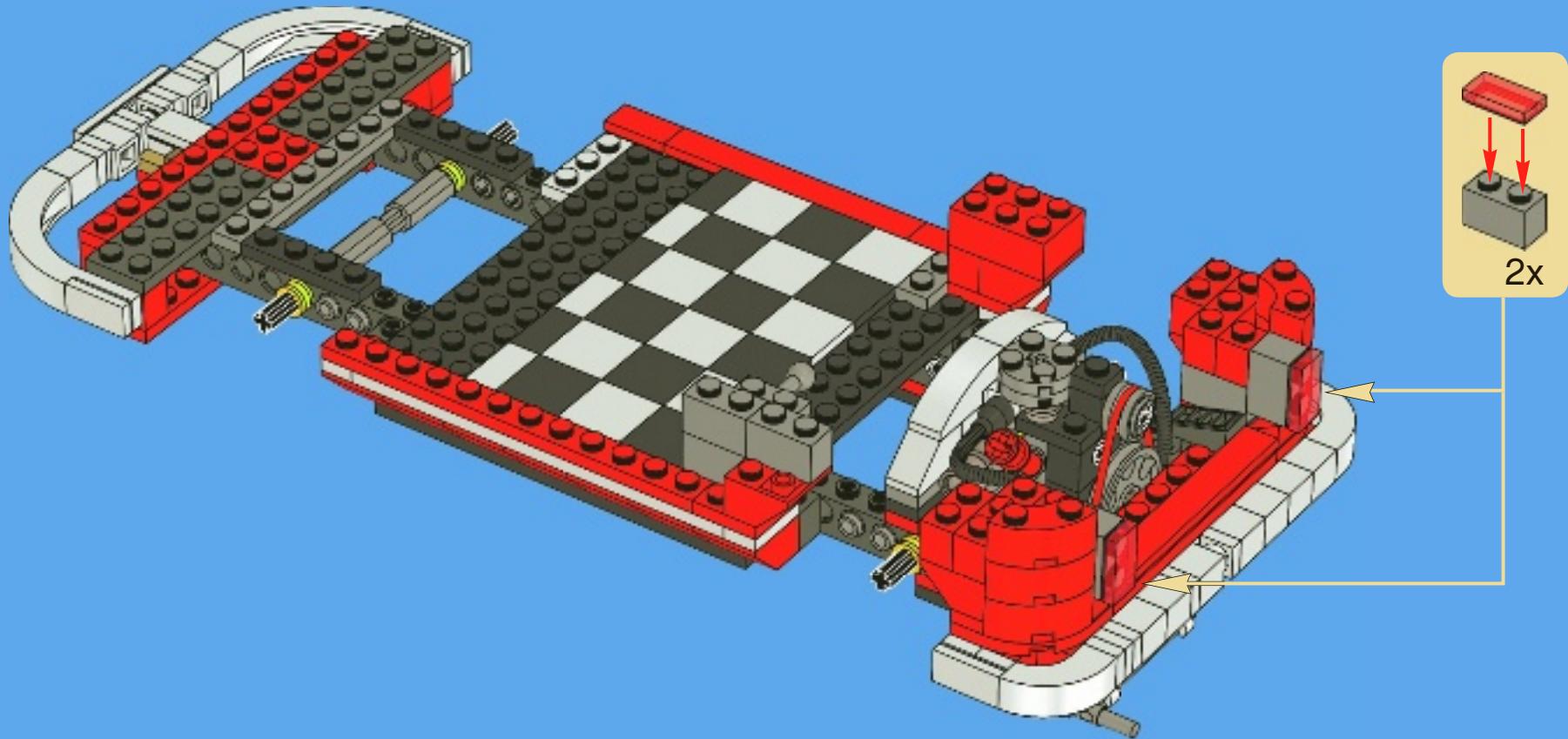

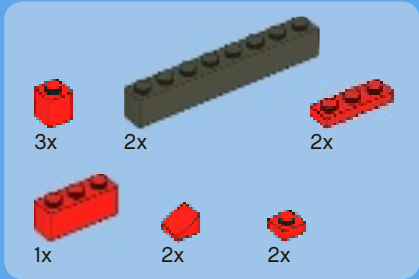

31

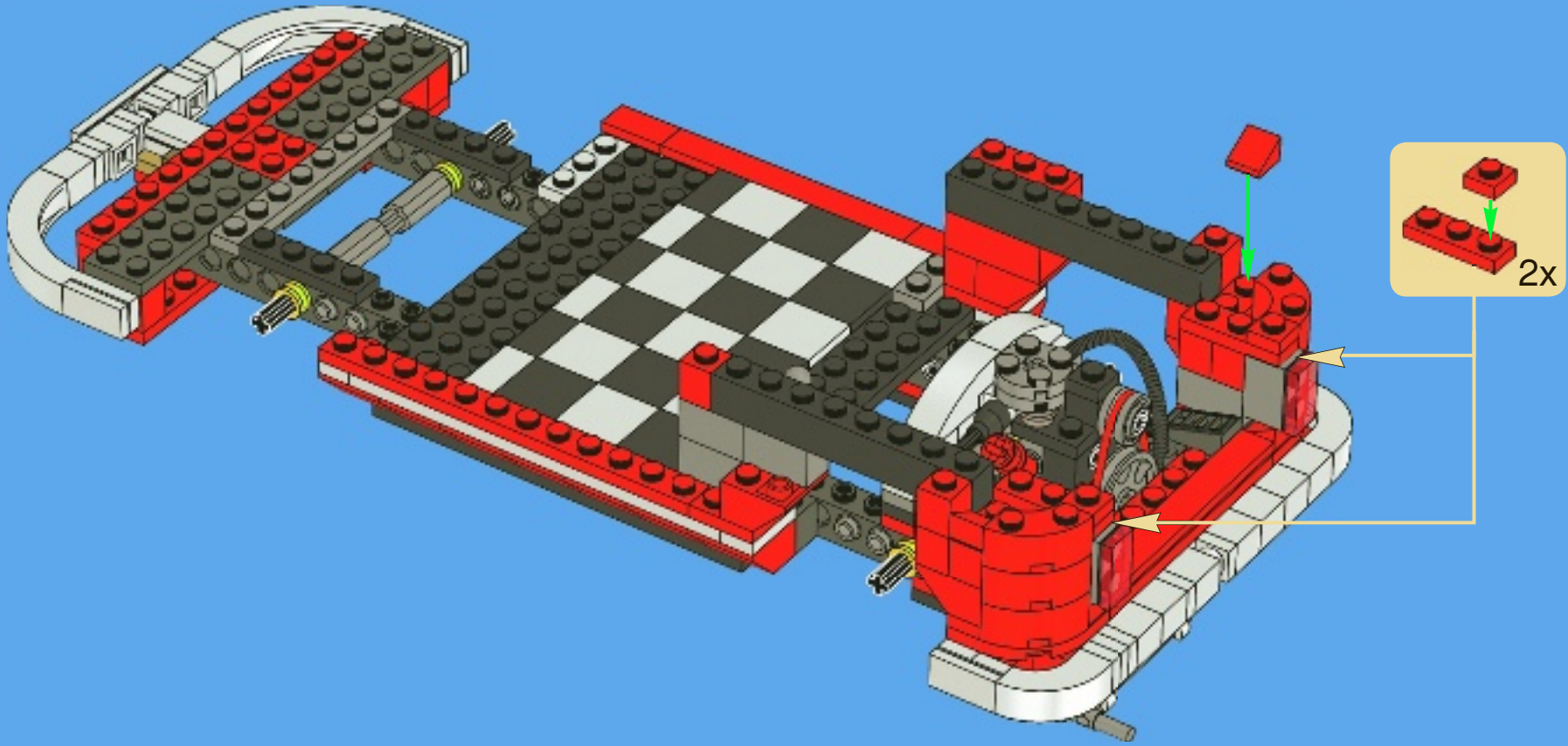

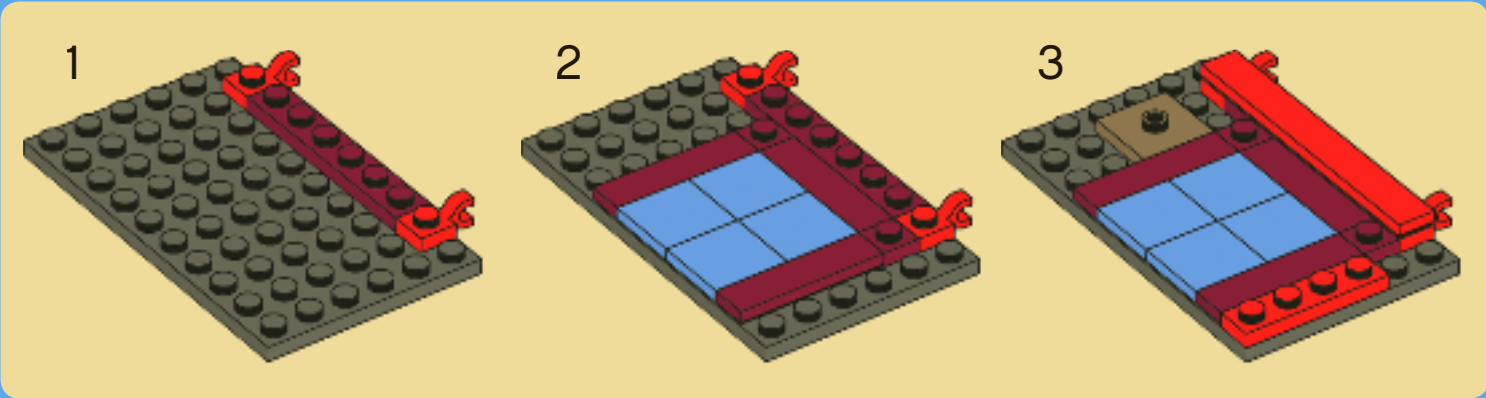
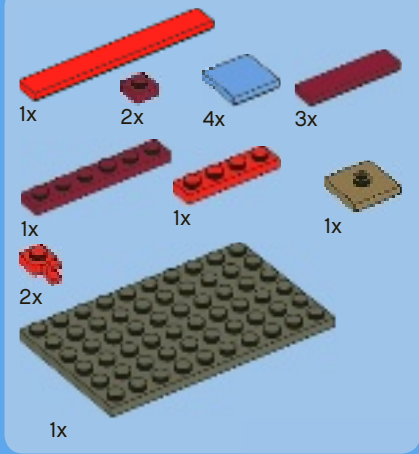

32

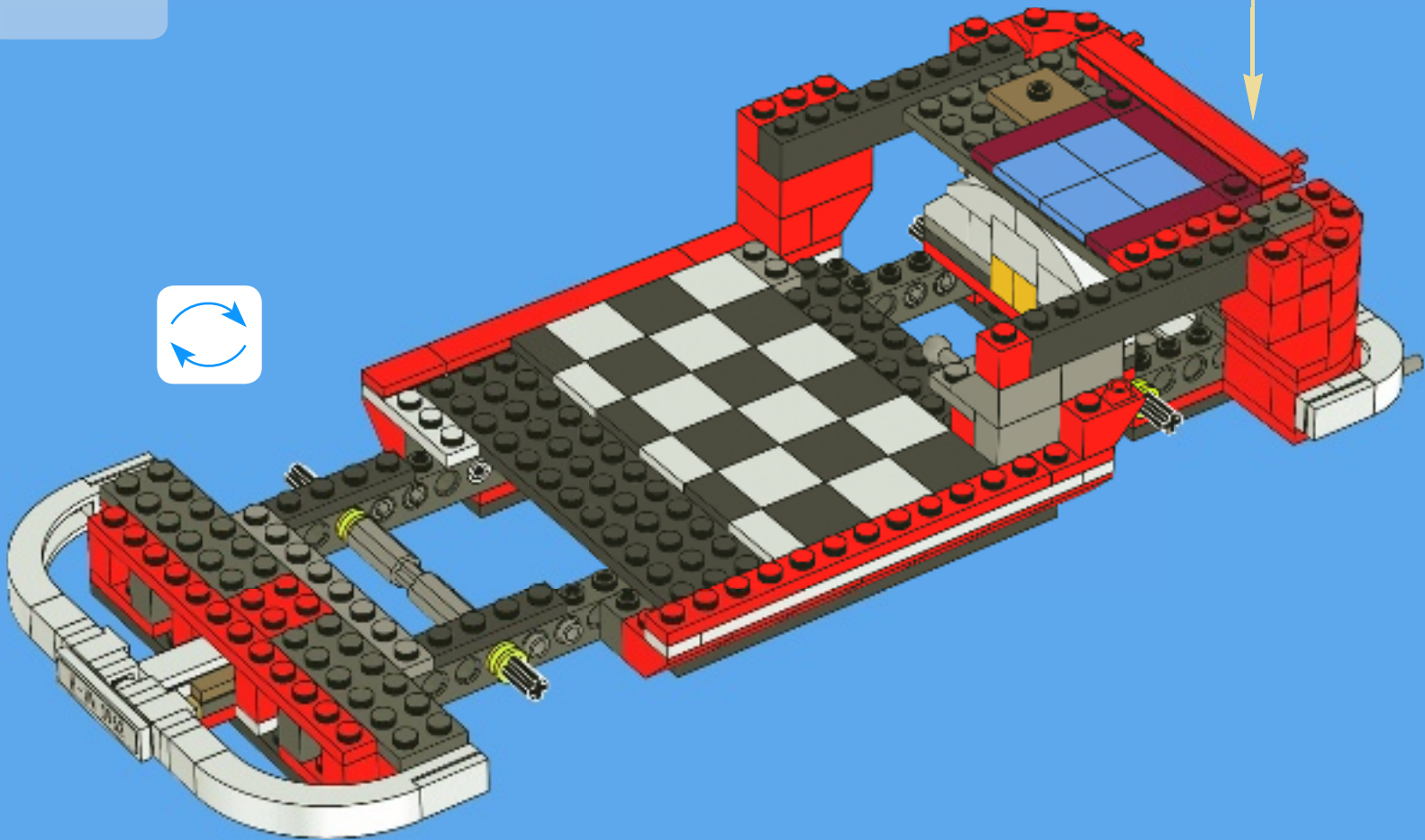

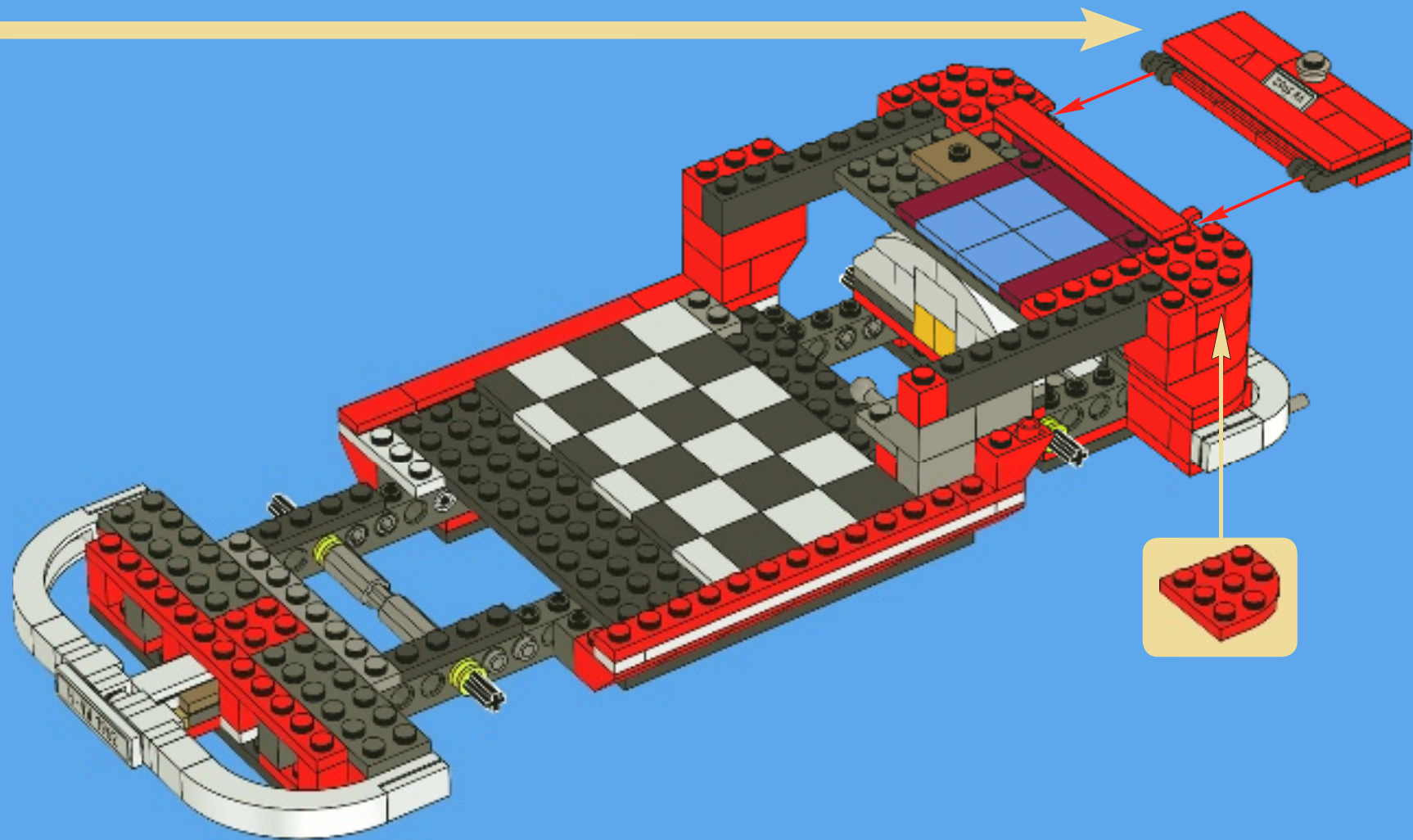



34

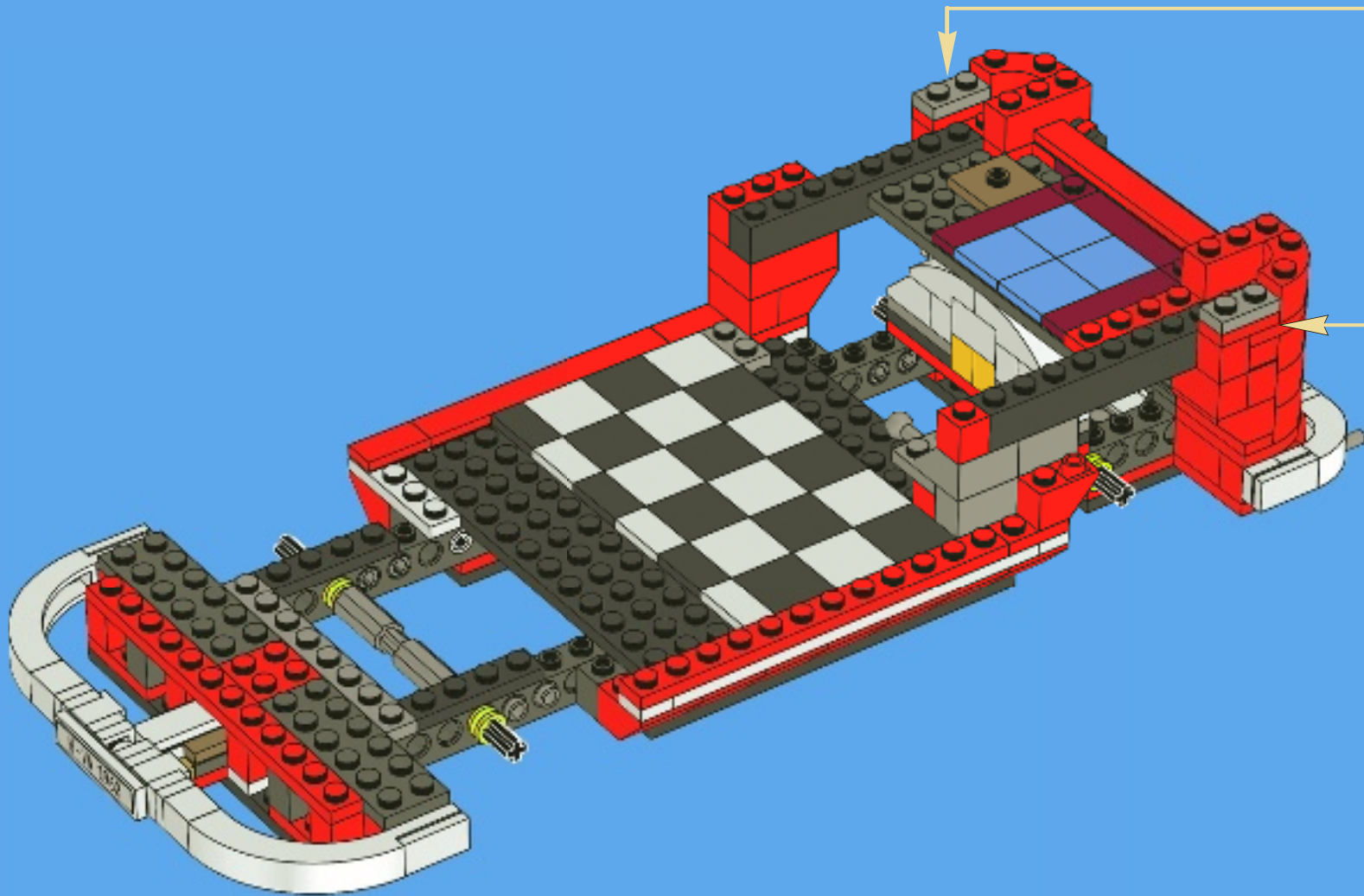
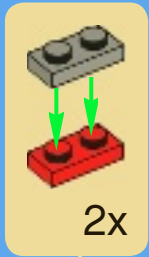

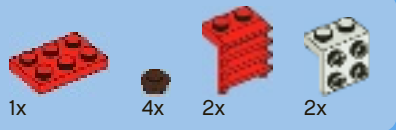

35

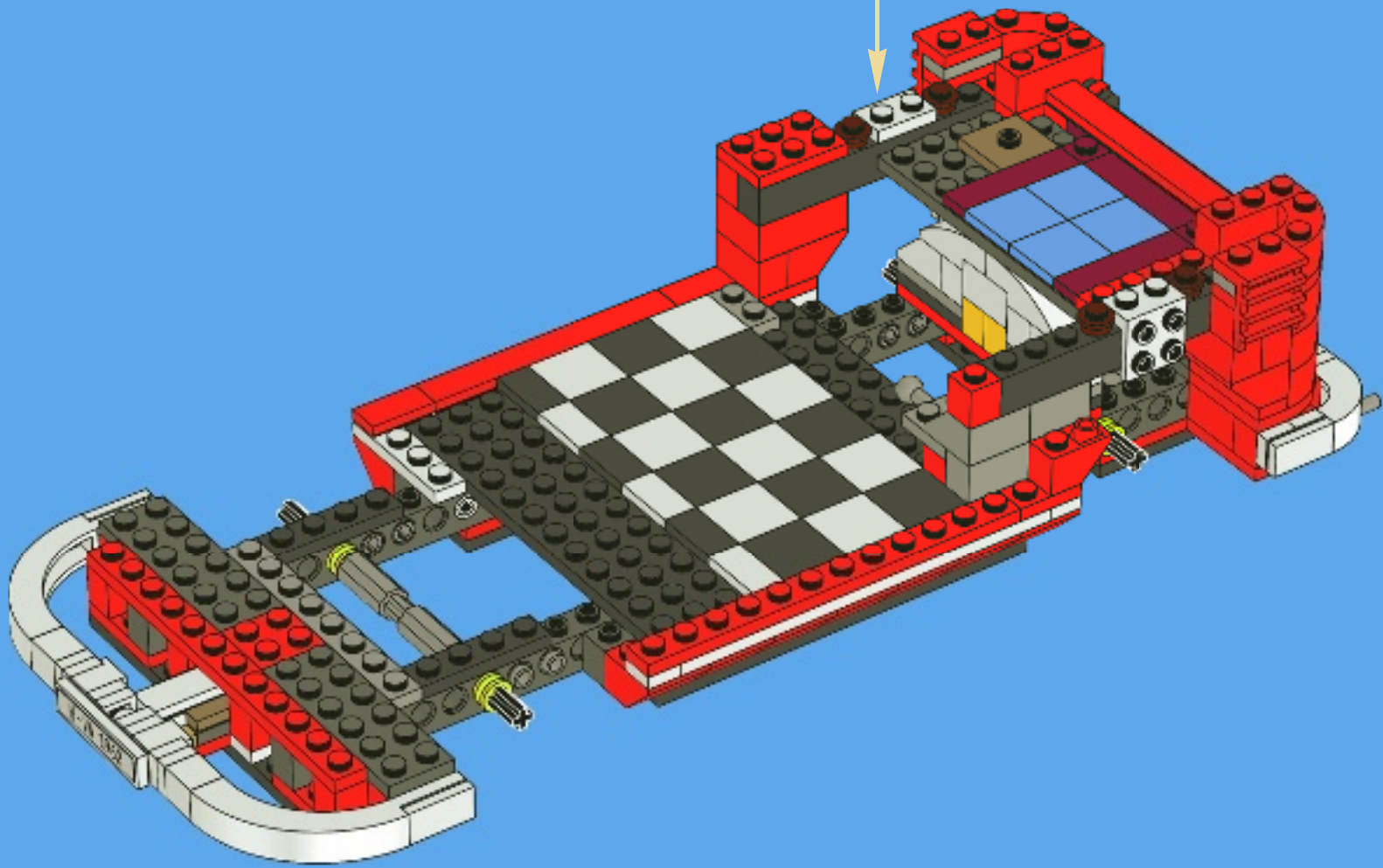



36

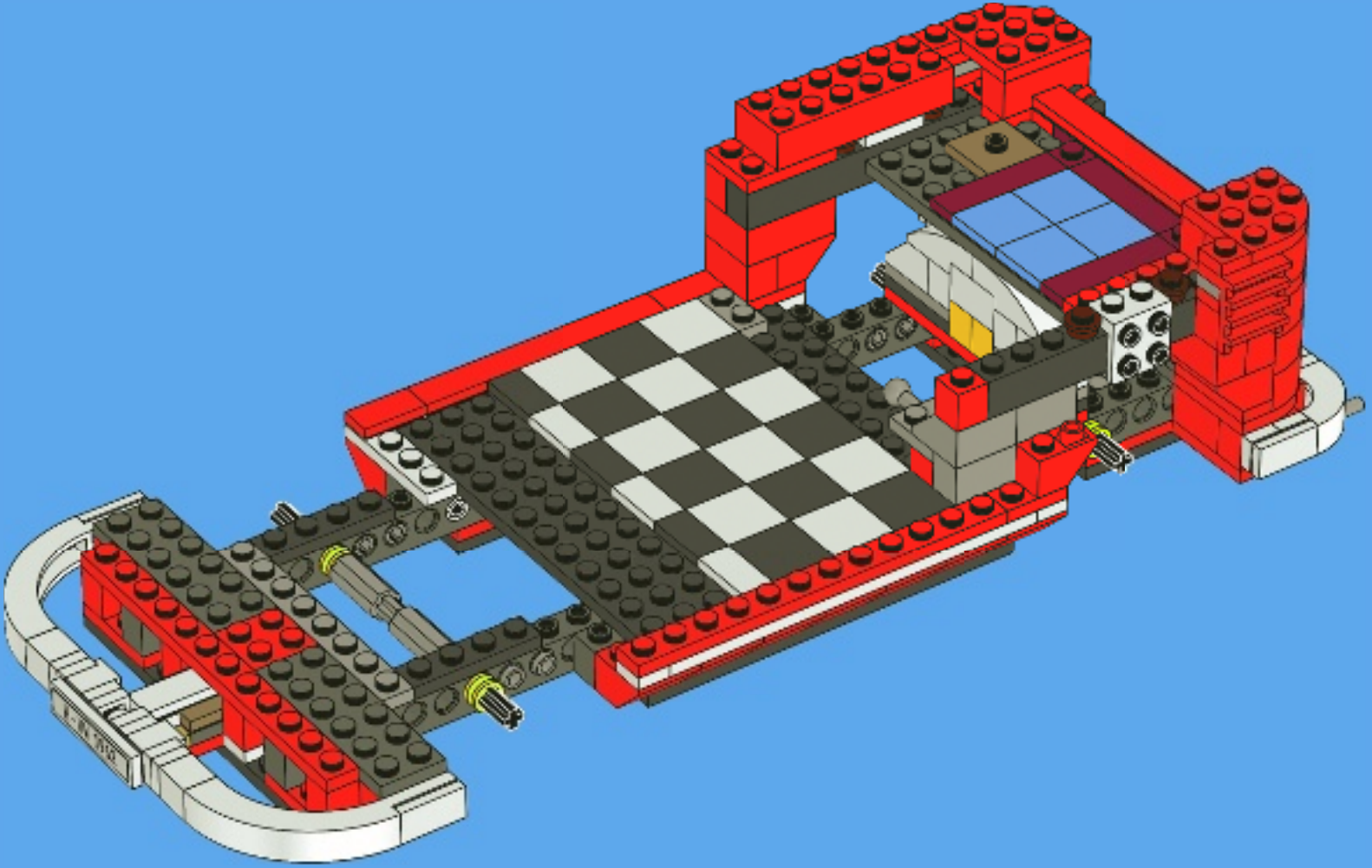

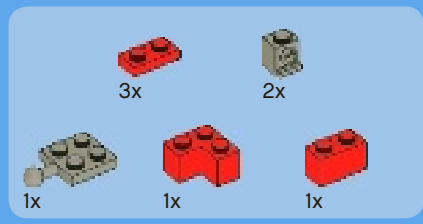

37

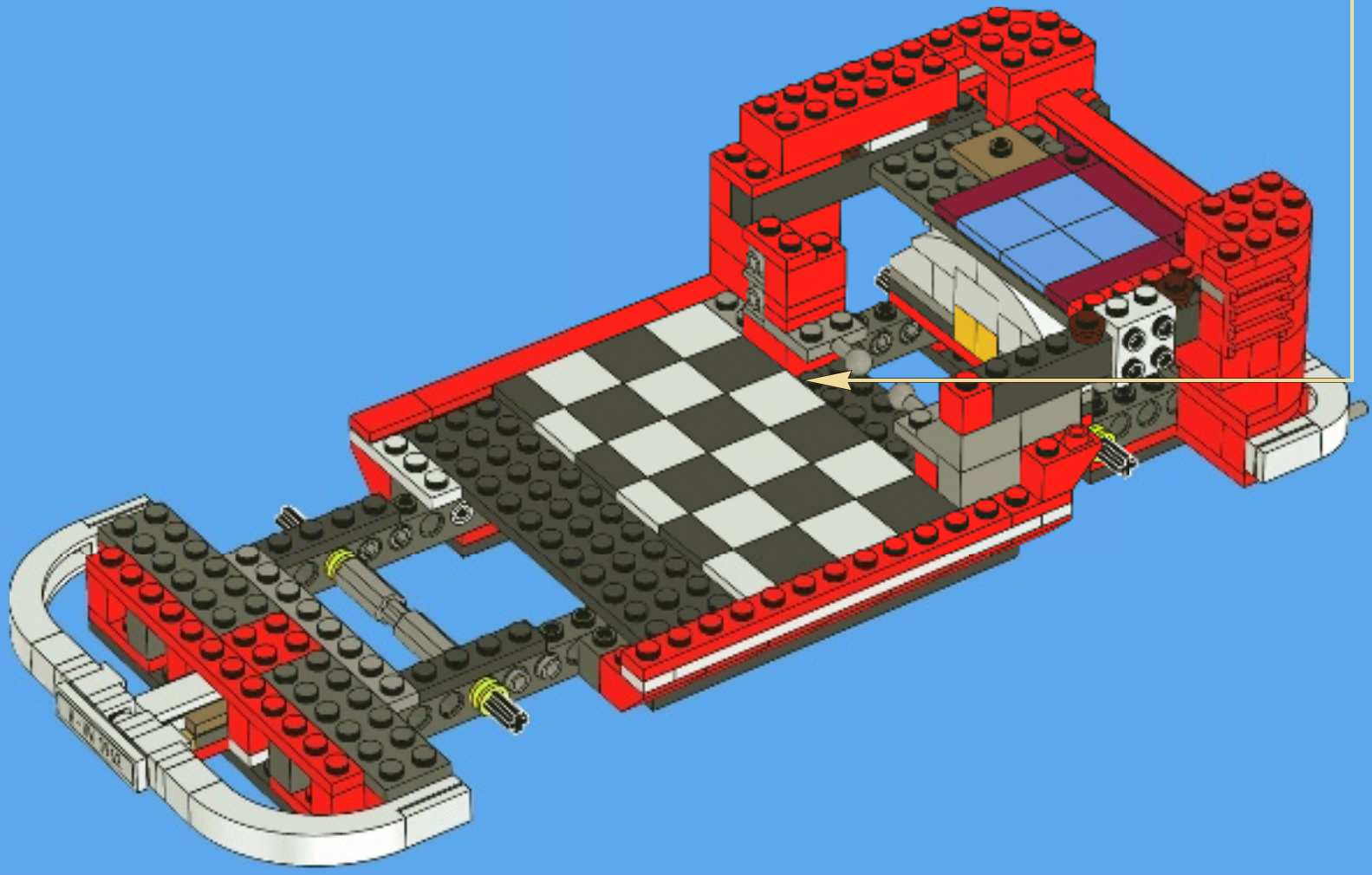
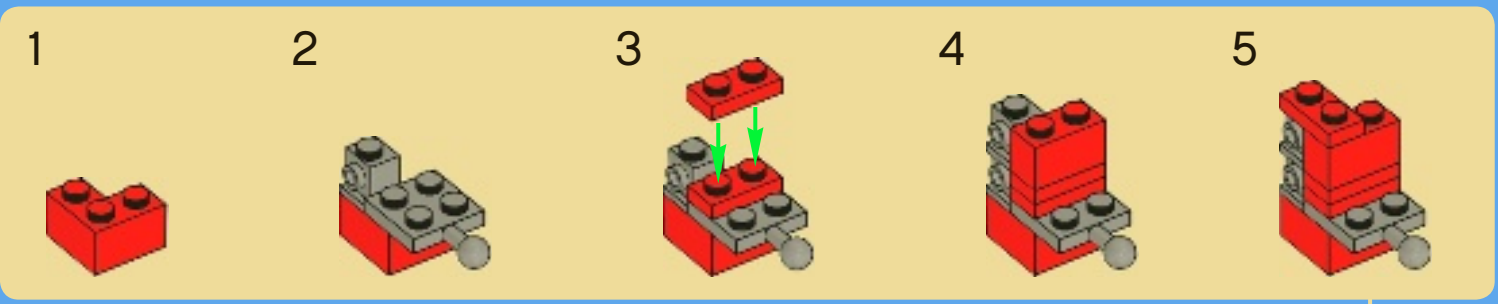



1

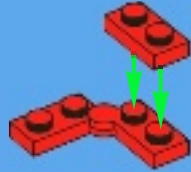

2

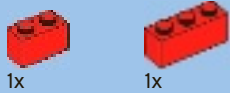

3

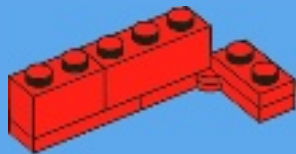

4

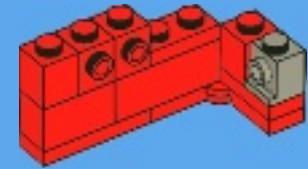

5

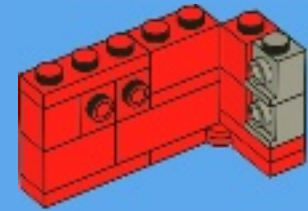

6

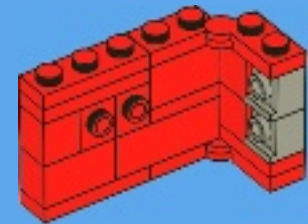

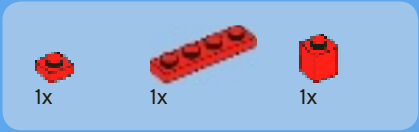

7

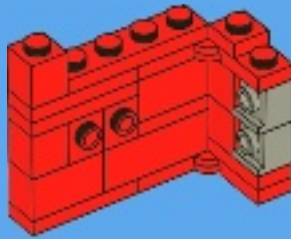

8

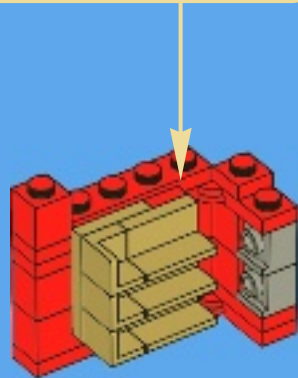
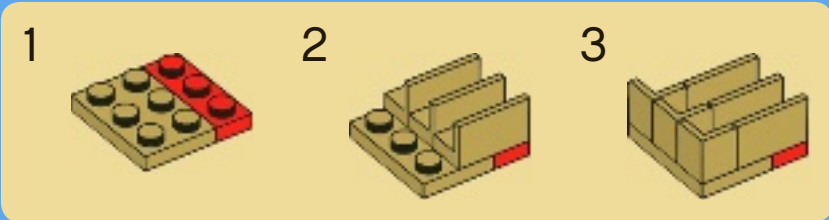

38

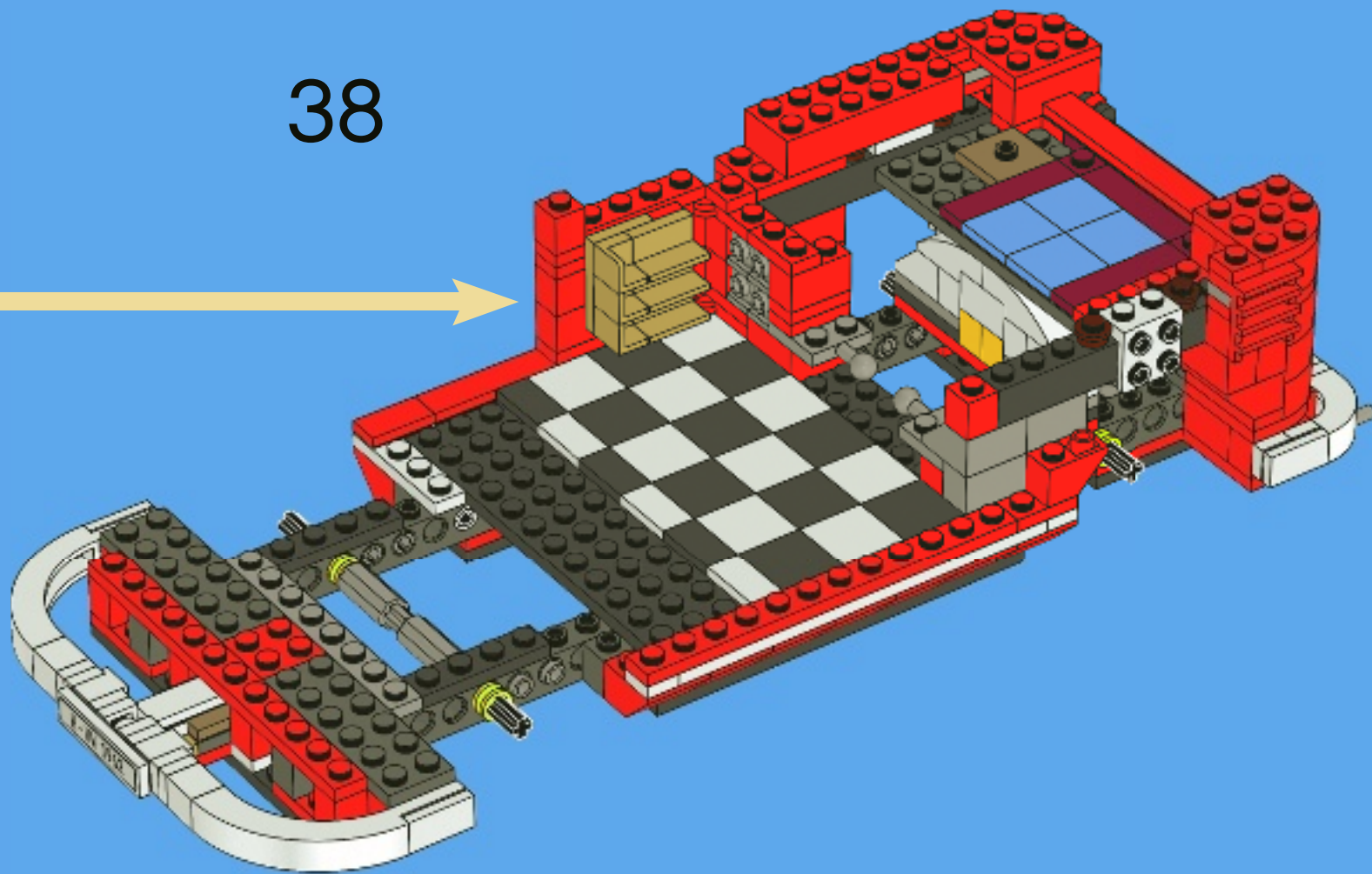



1x



2x



2x



1x

39

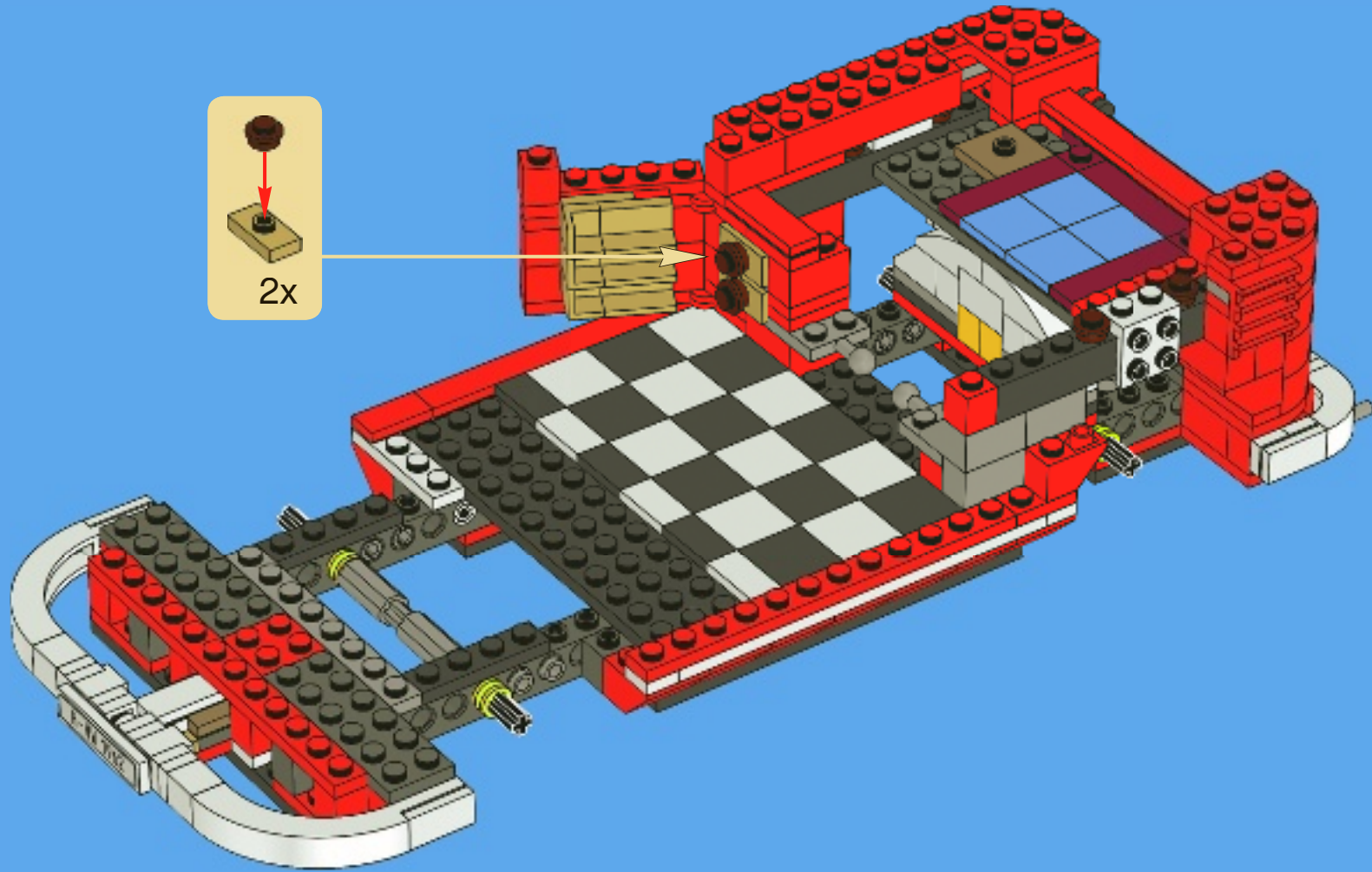
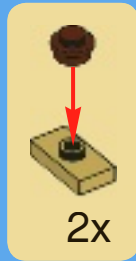



2x



1x



2x

40

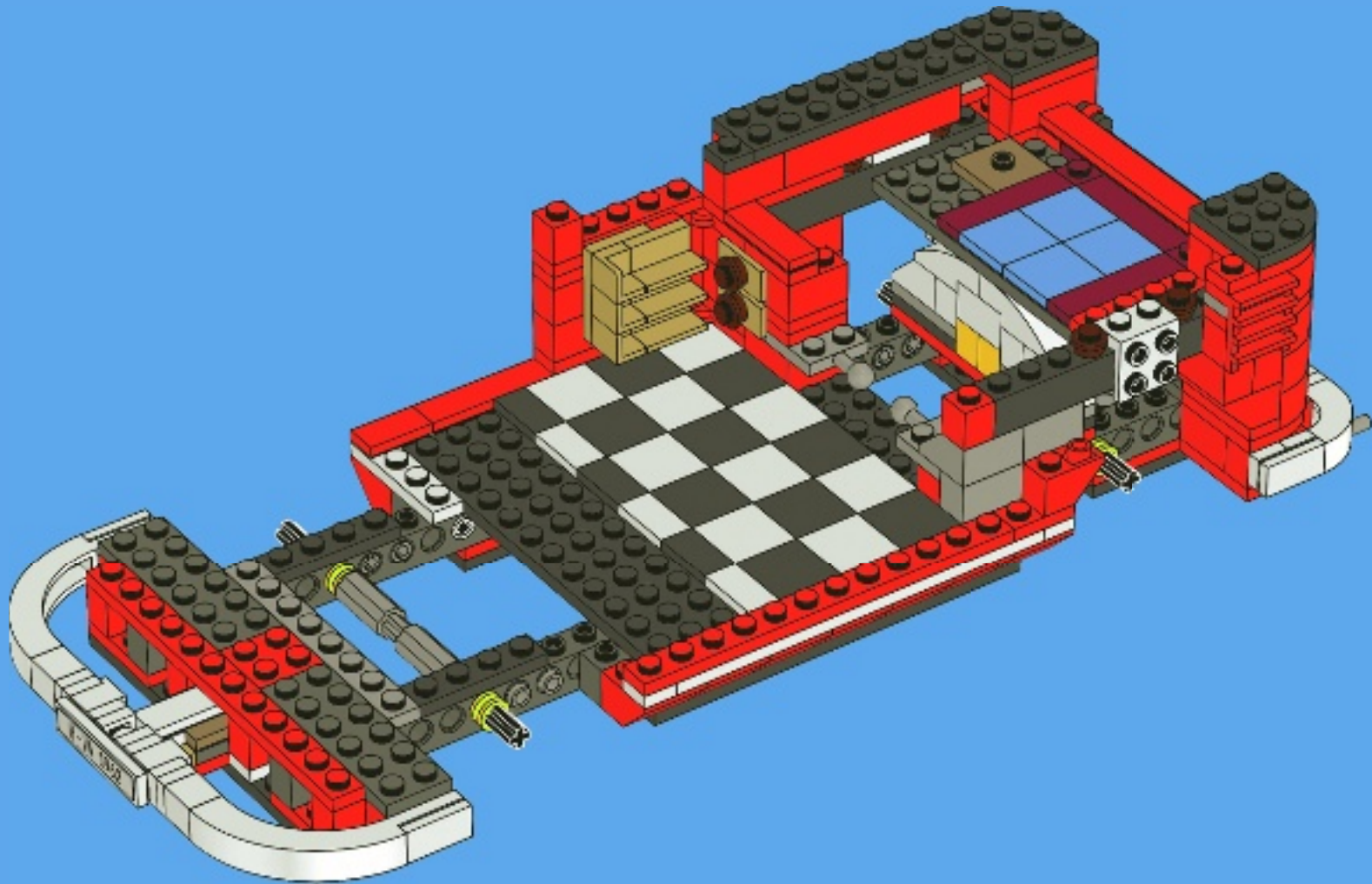



1

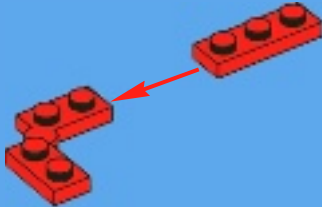

2

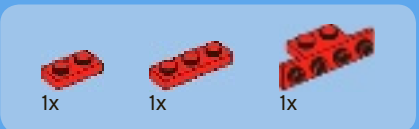
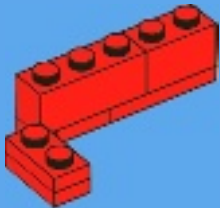

3

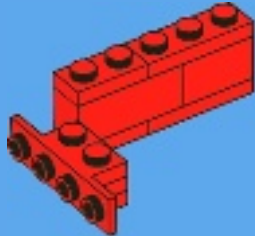

4

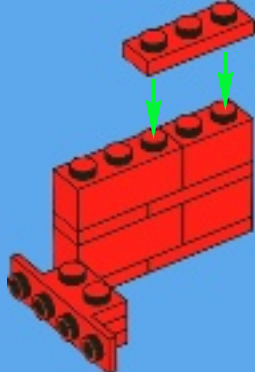



1x

5

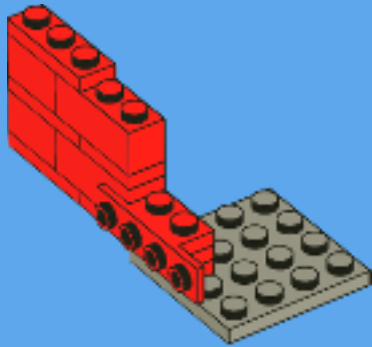

1x



1x



1x

6

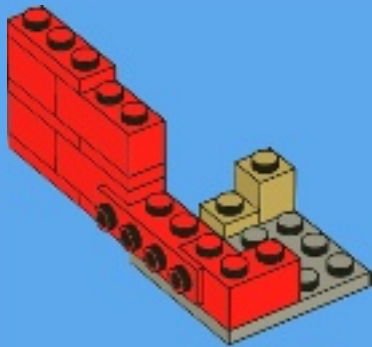

2x

7

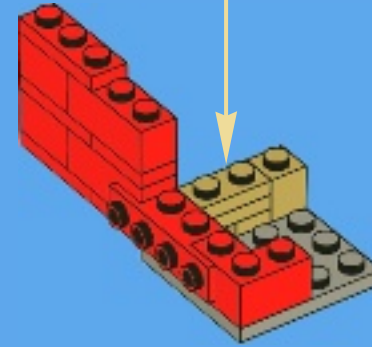
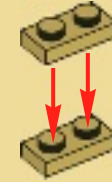

1x



1x



1x



1x



1x



1x

8

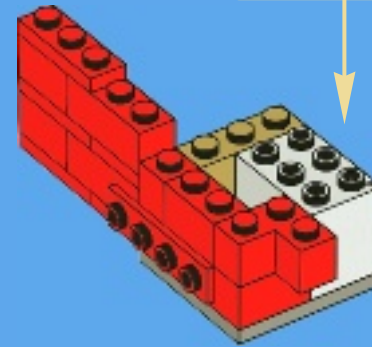
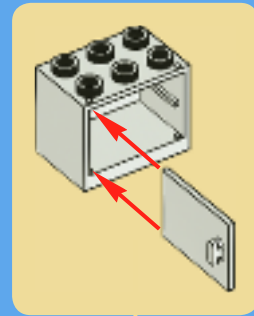

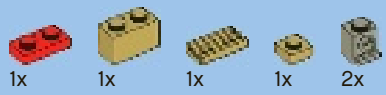

9

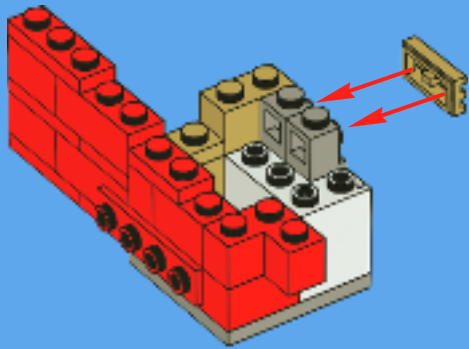

10

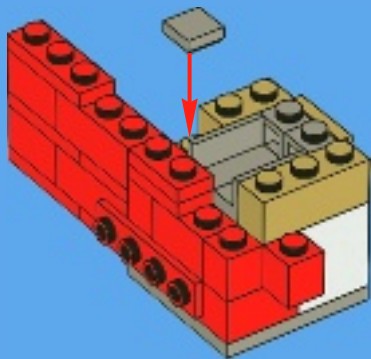

11

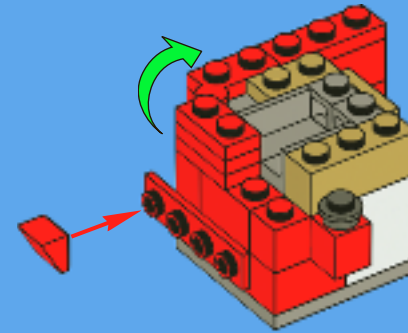

12

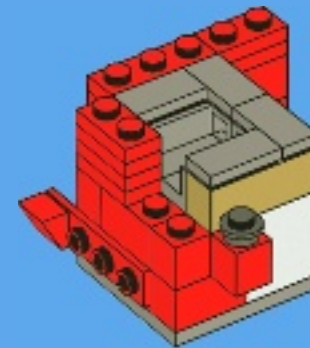

41

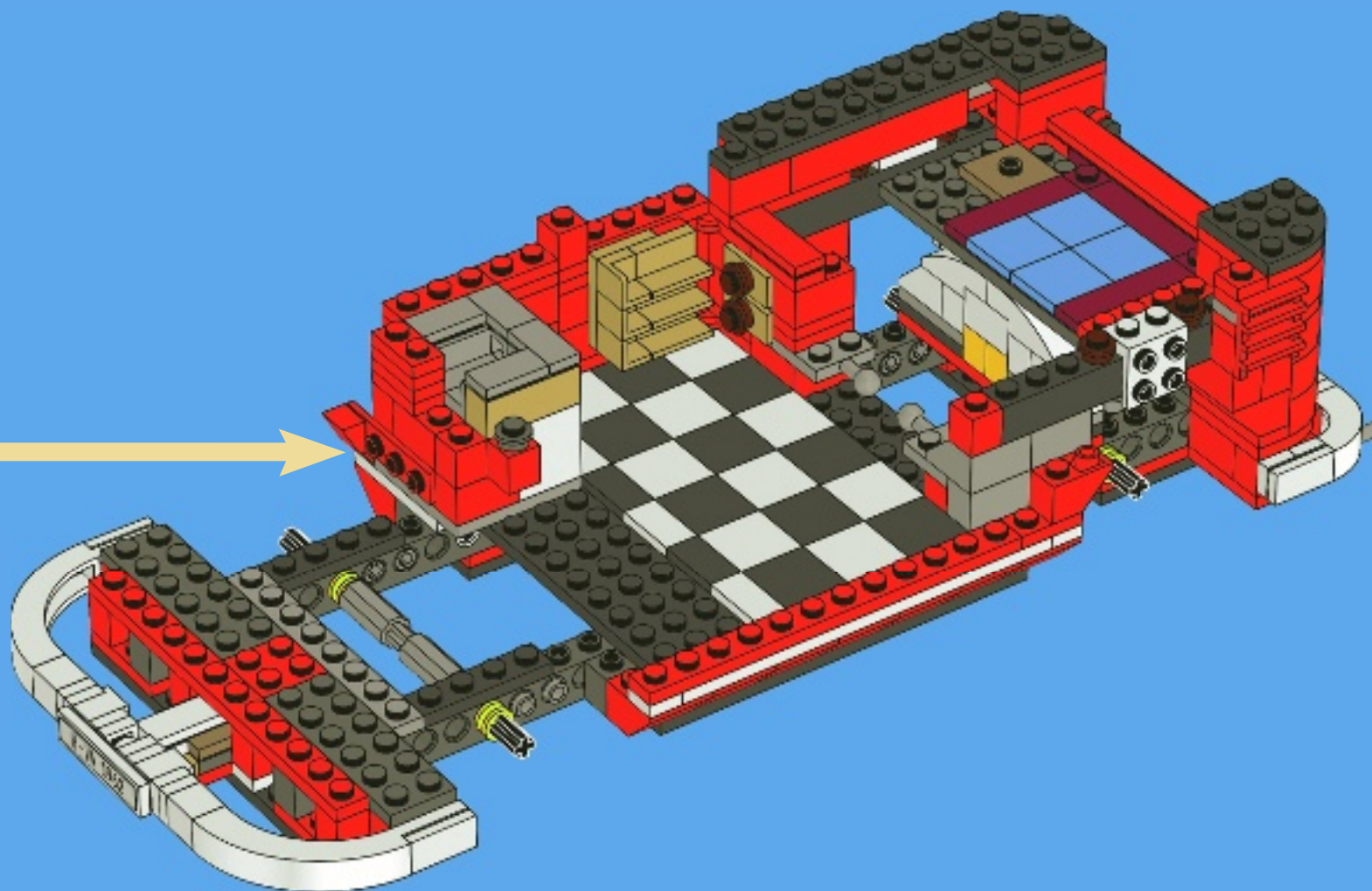

- 1x
- 1x
- 4x
- 1x
- 1x

42

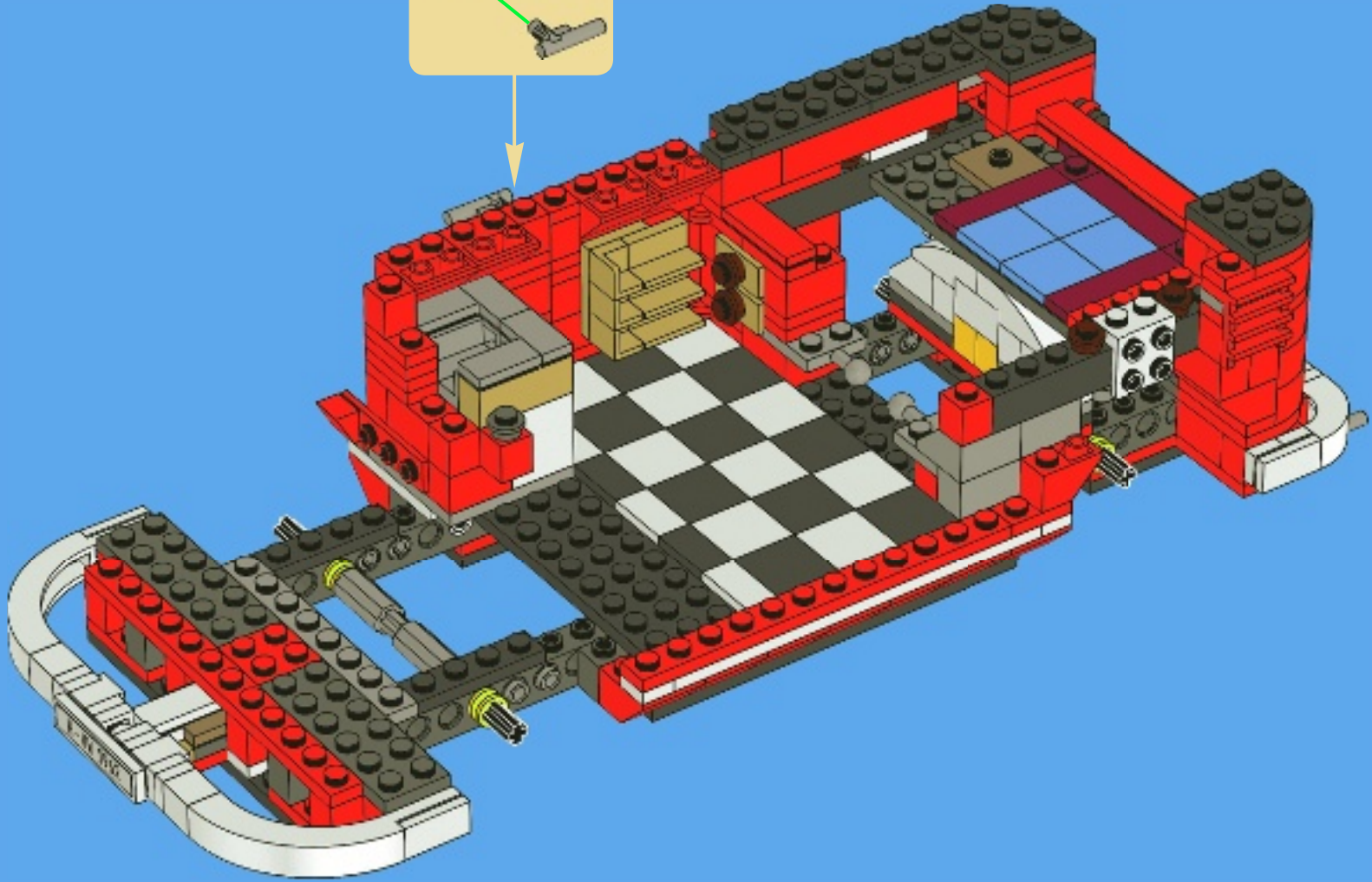
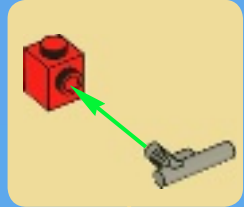



2x



1x



2x

43

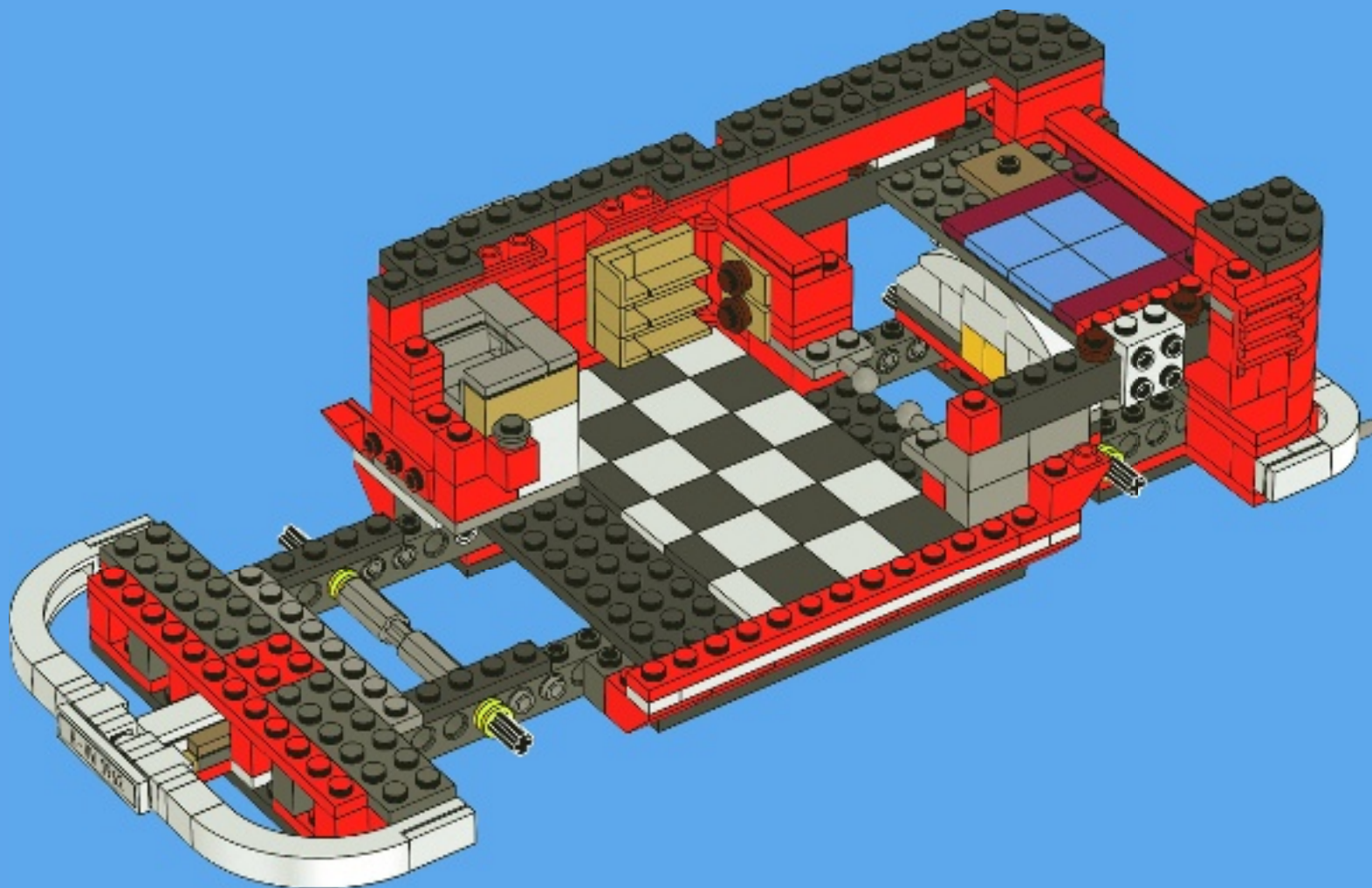

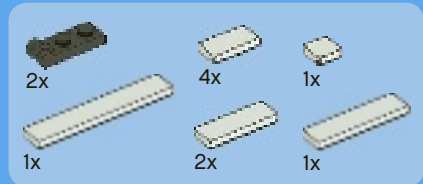

44

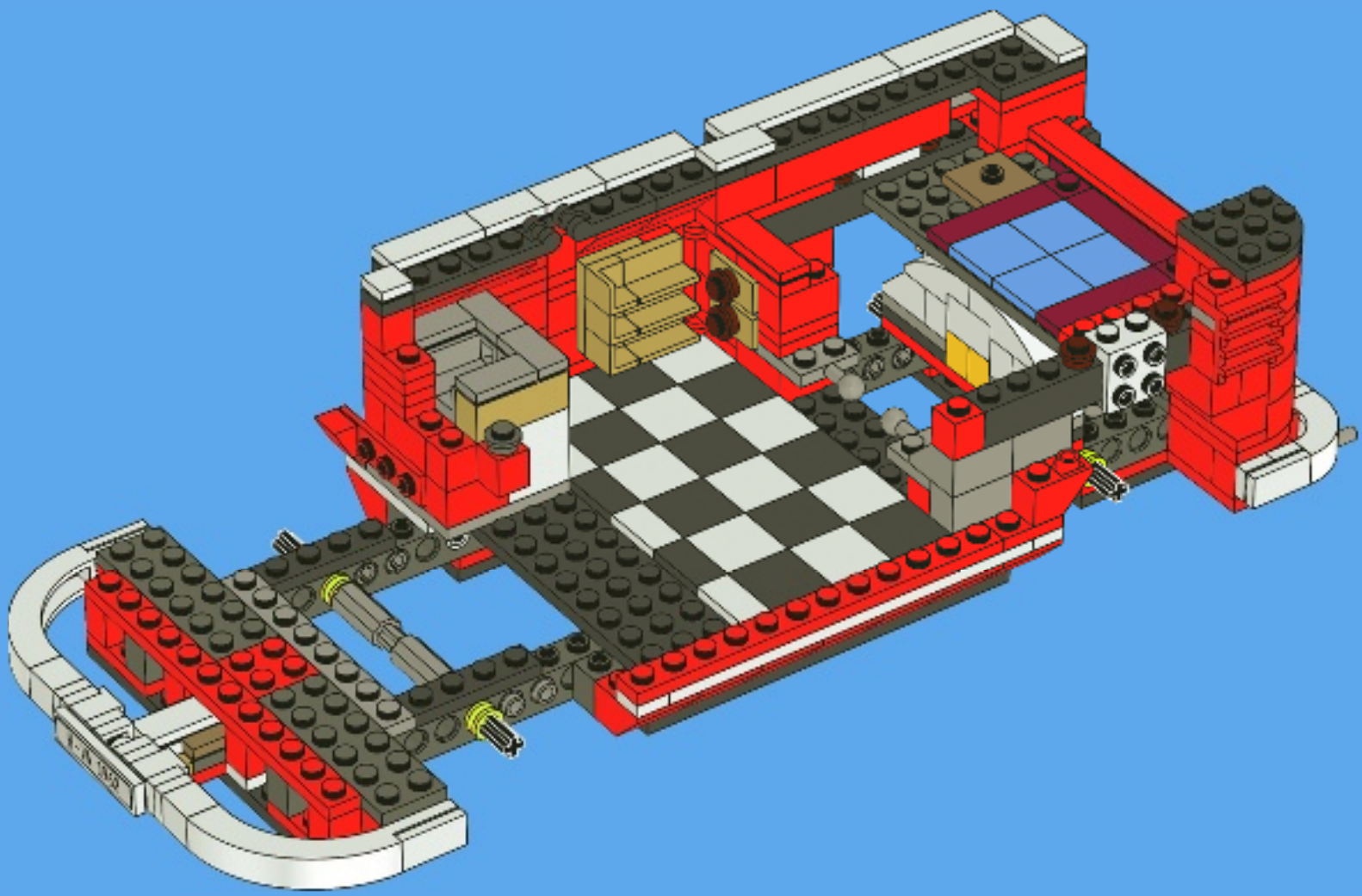



45

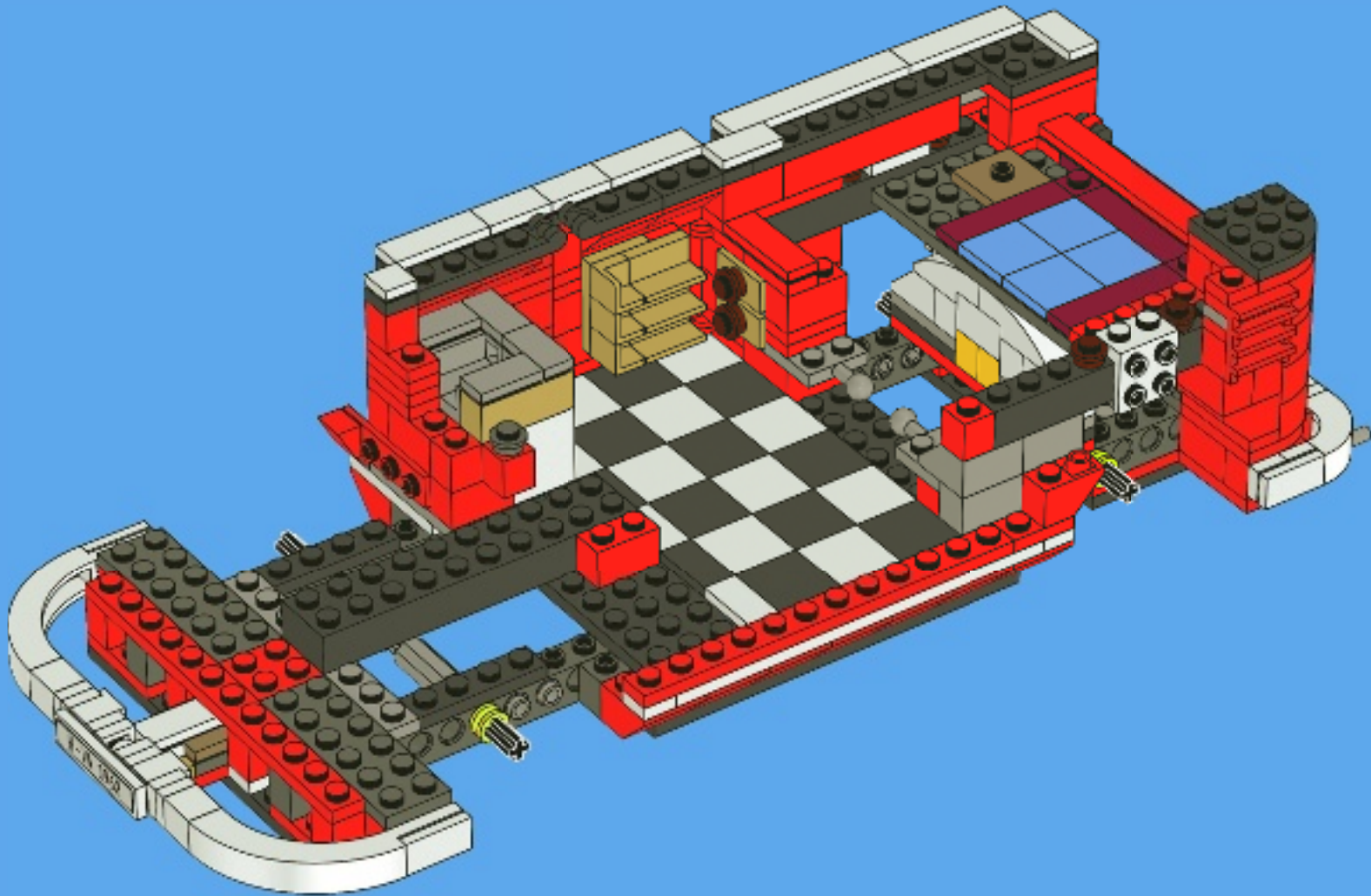



3x



1x

46

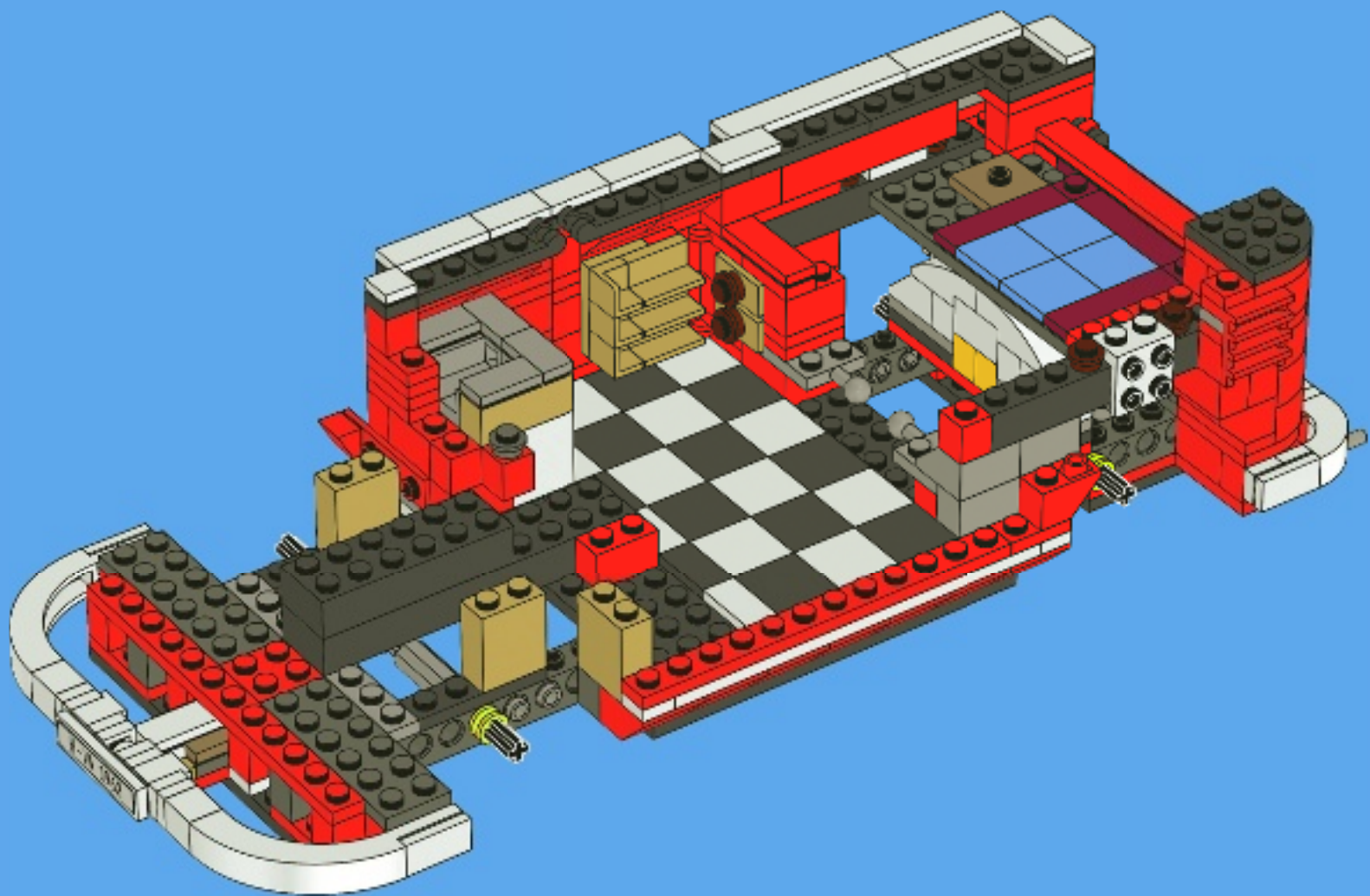



1x



1x

47

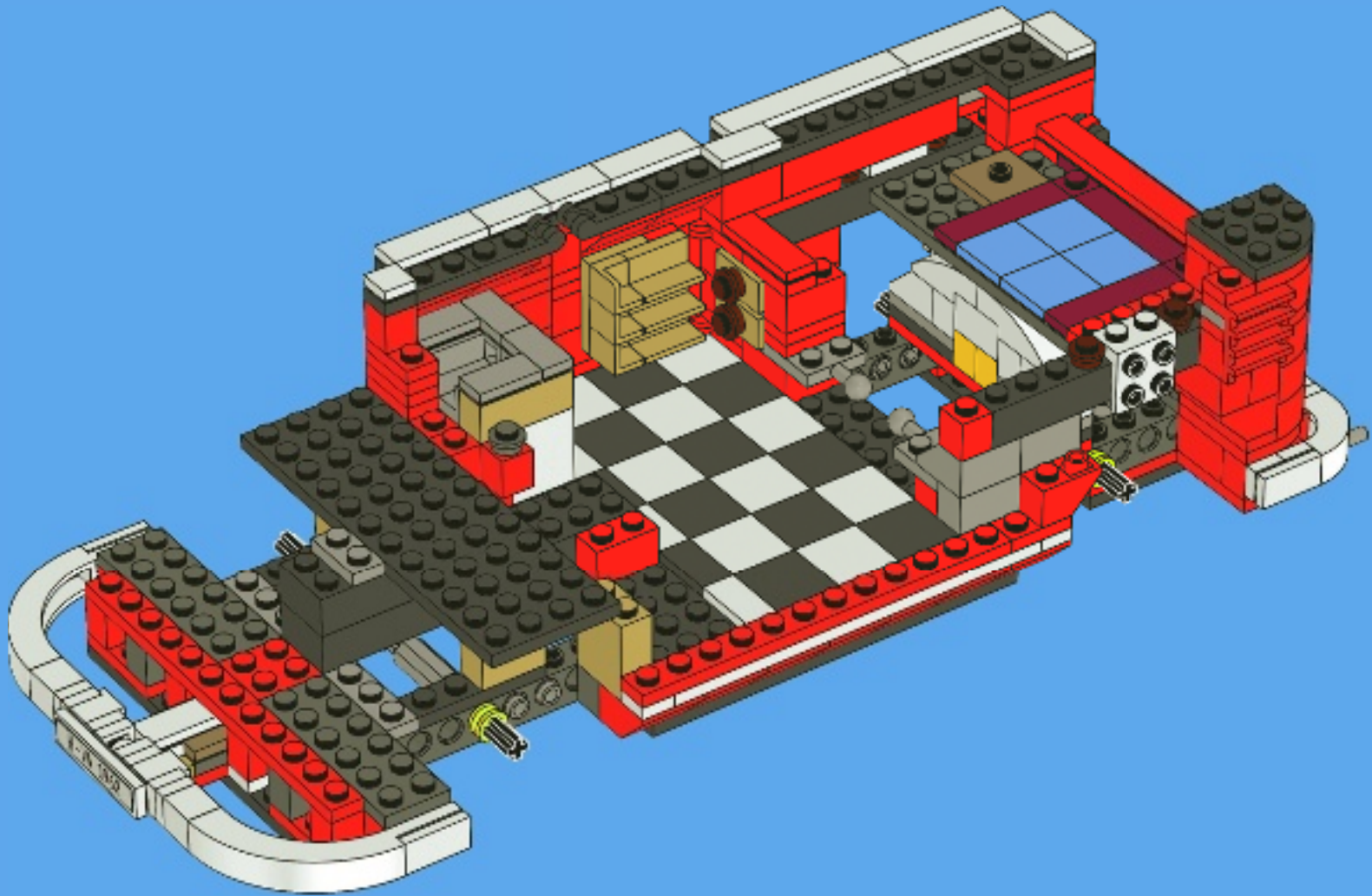



2x



2x



1x



4x

48

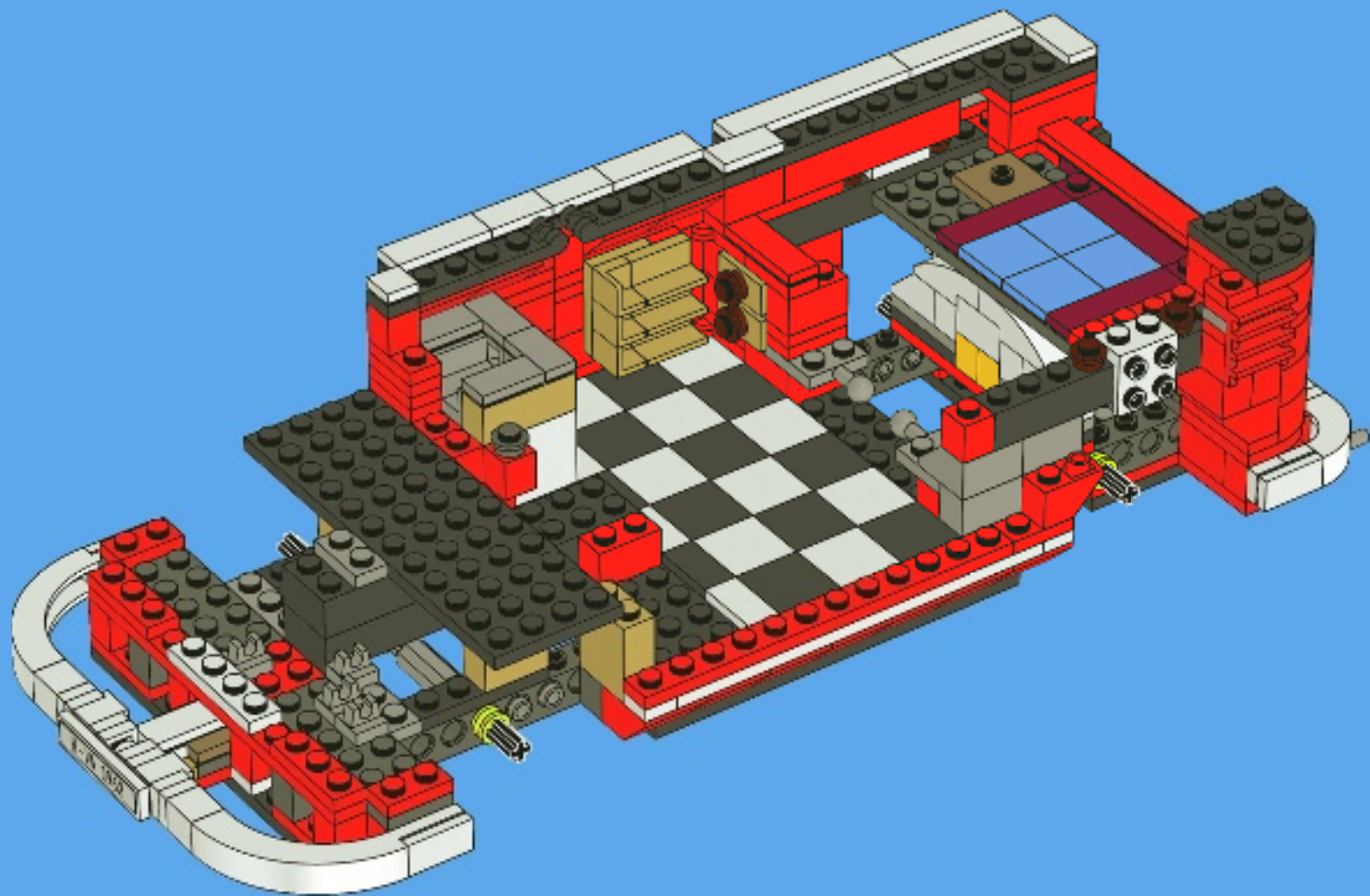

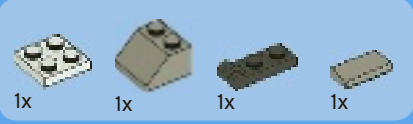

49

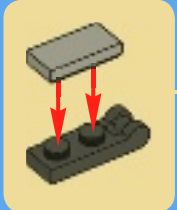
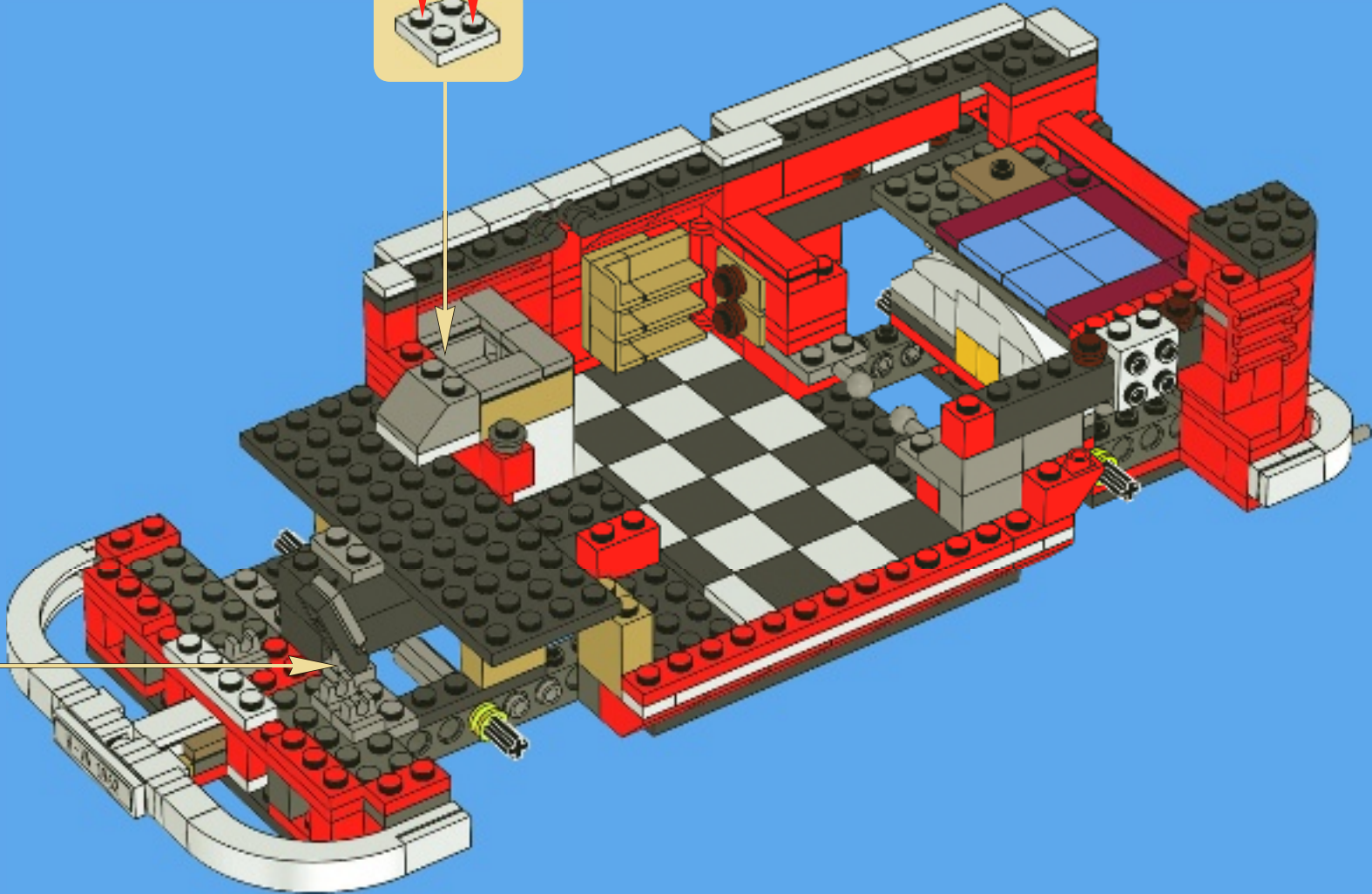
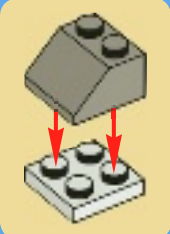

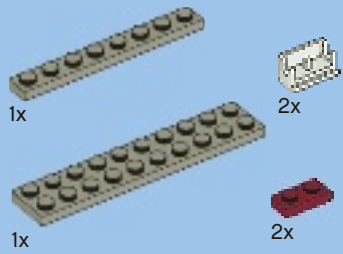

50

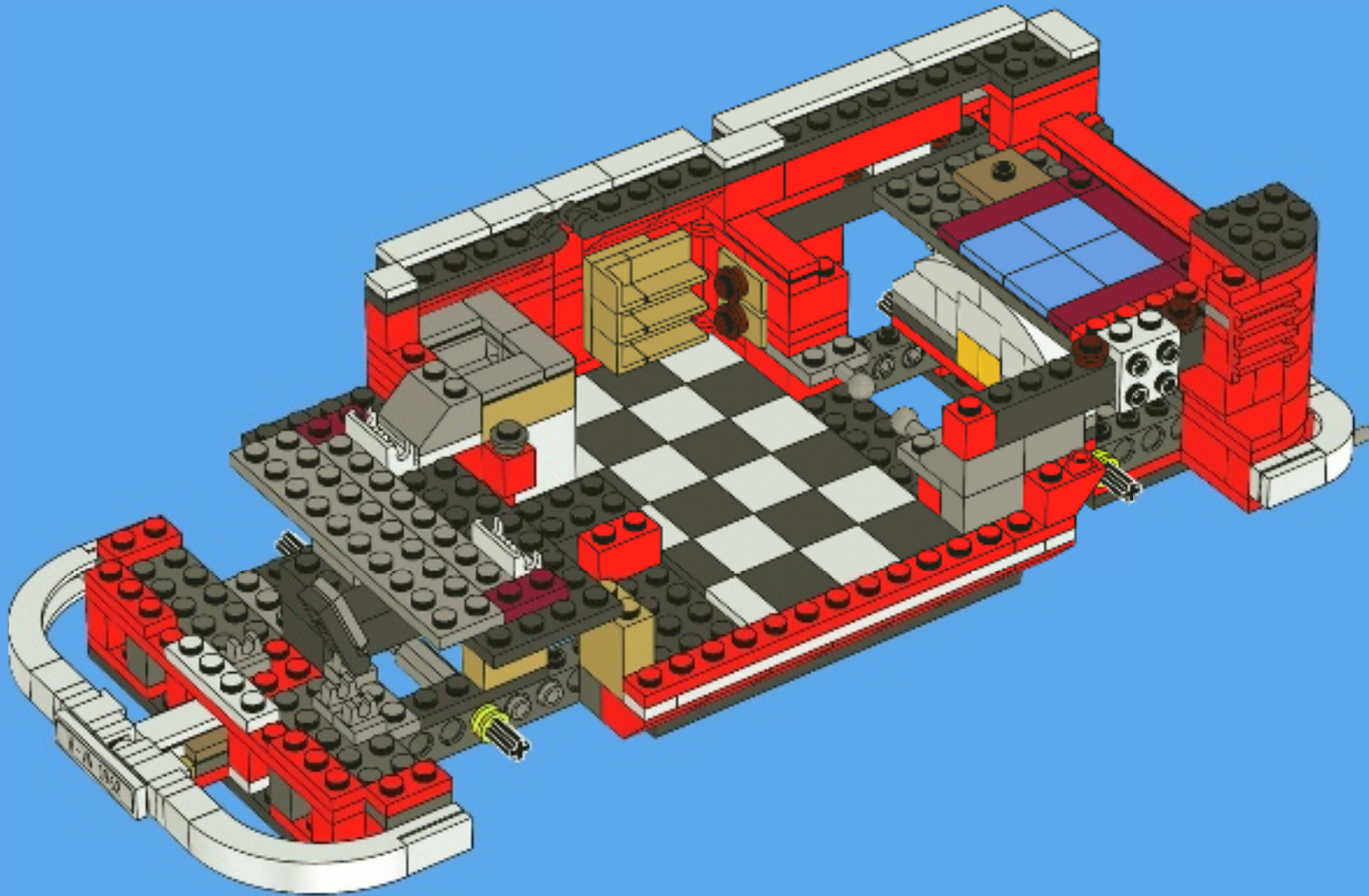

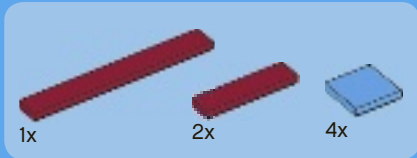

51

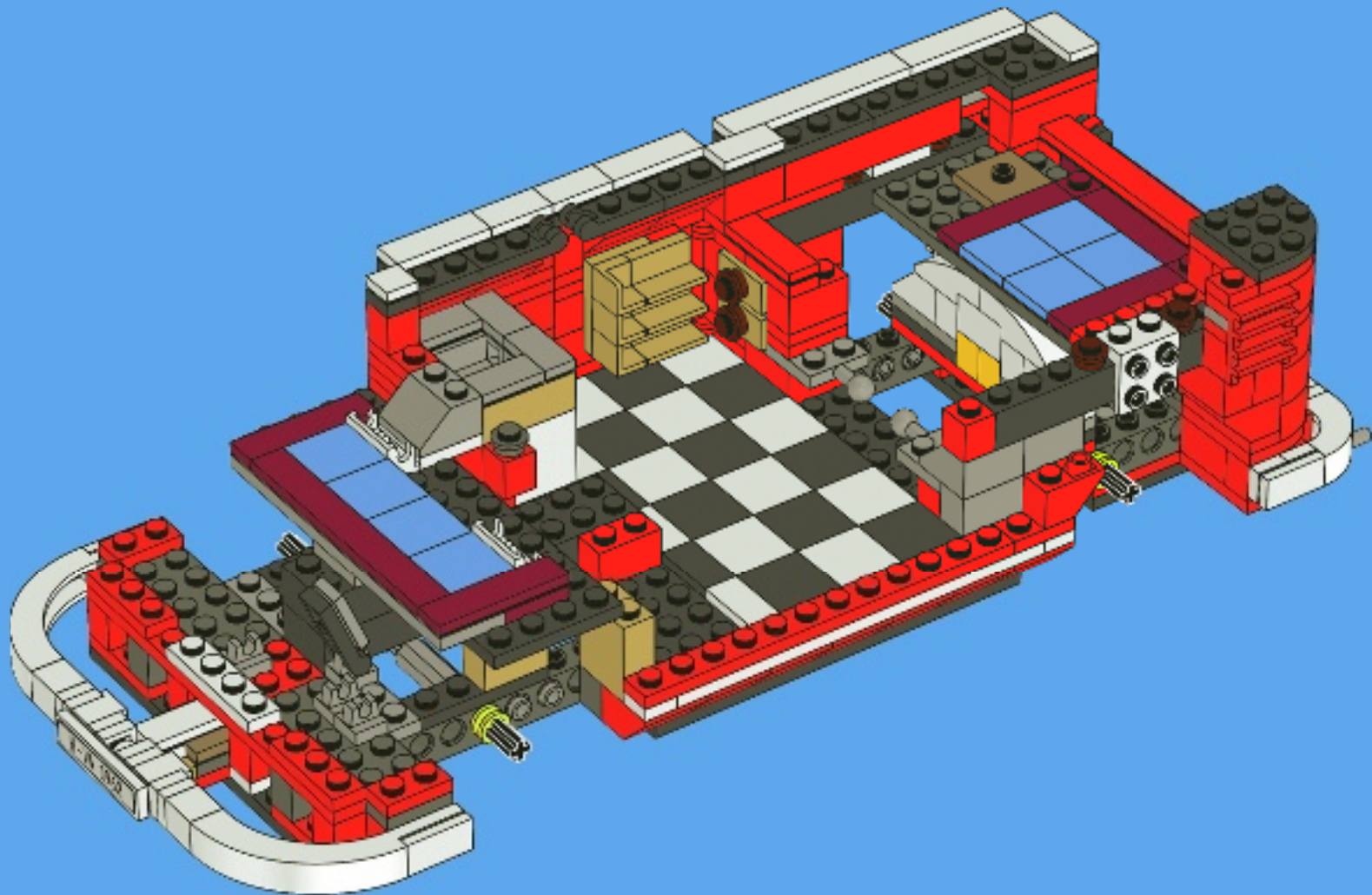



1x



1x



2x



1x

52

1



2

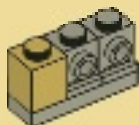

3

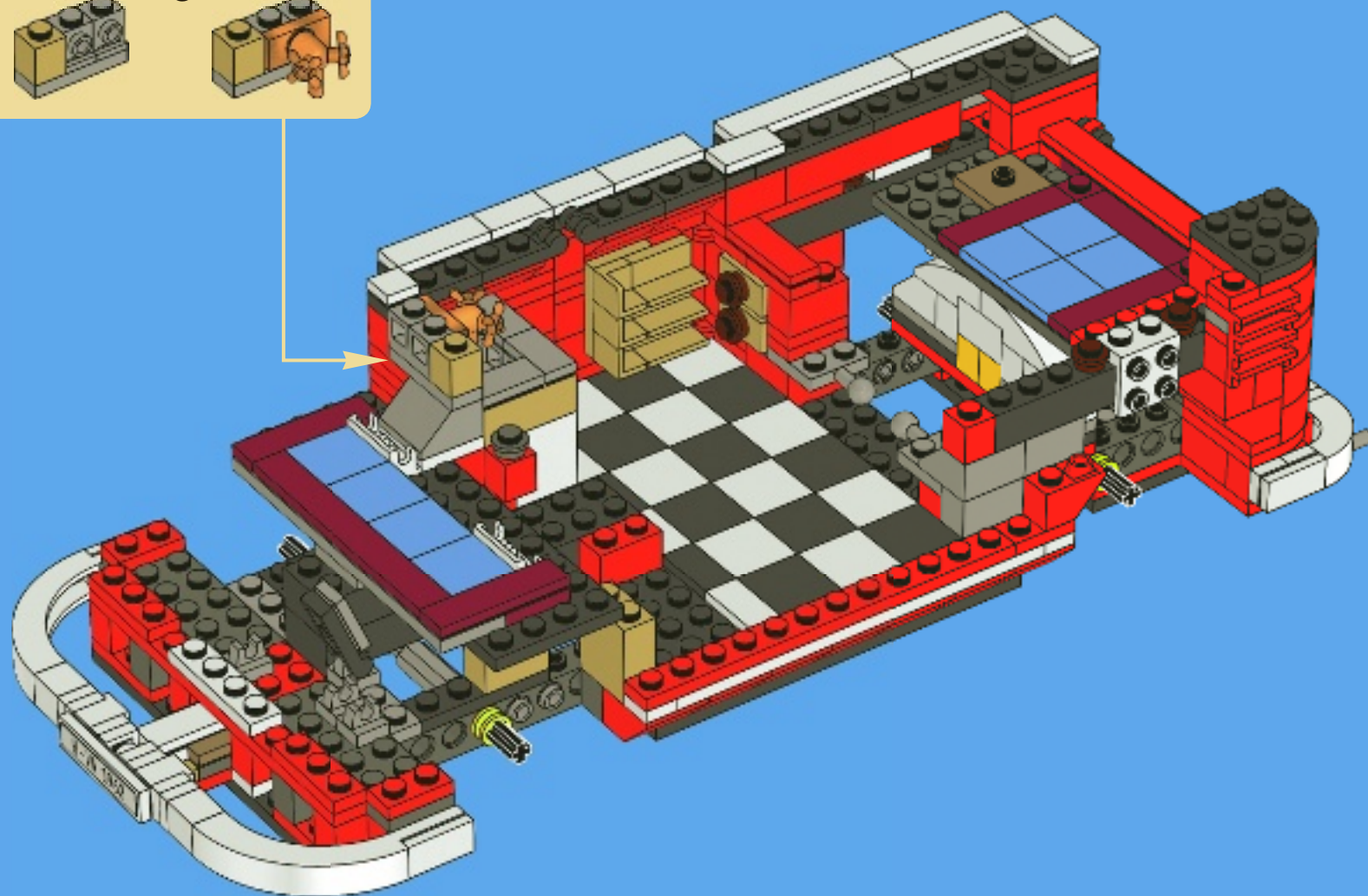



53

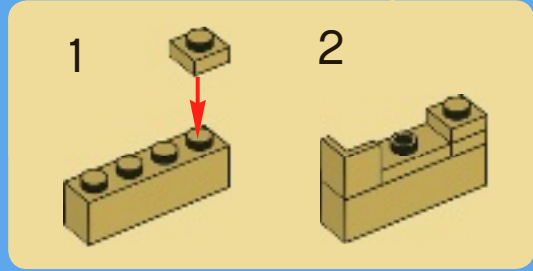
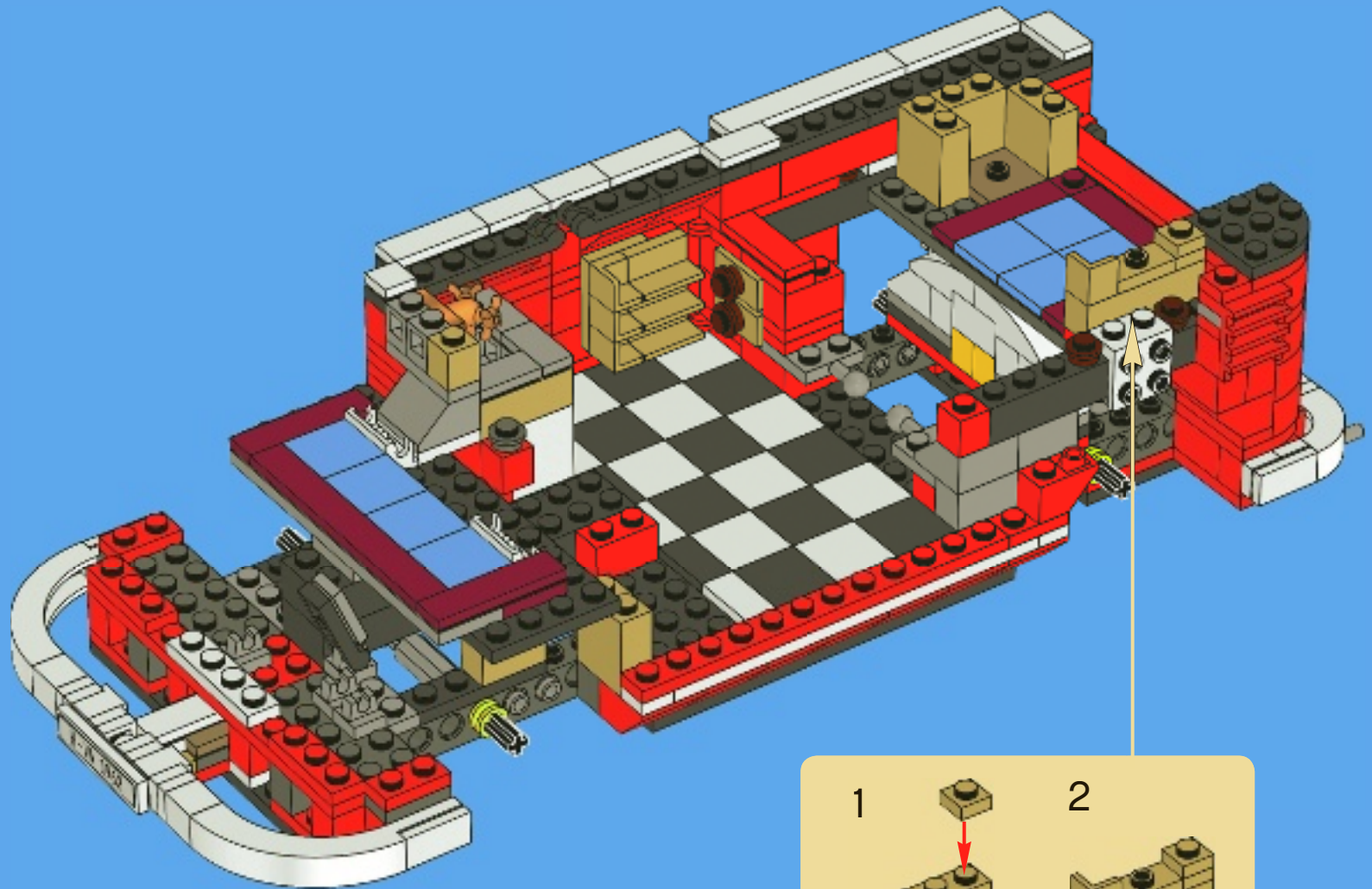

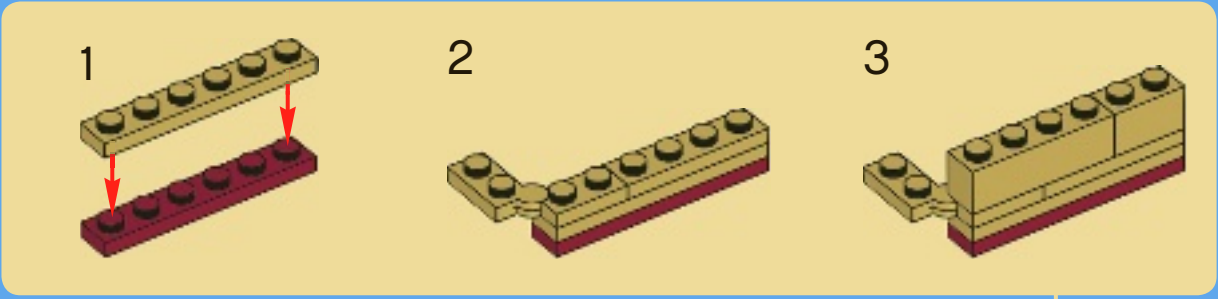
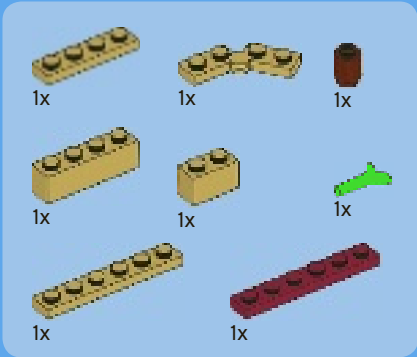

54

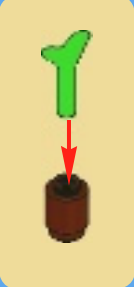
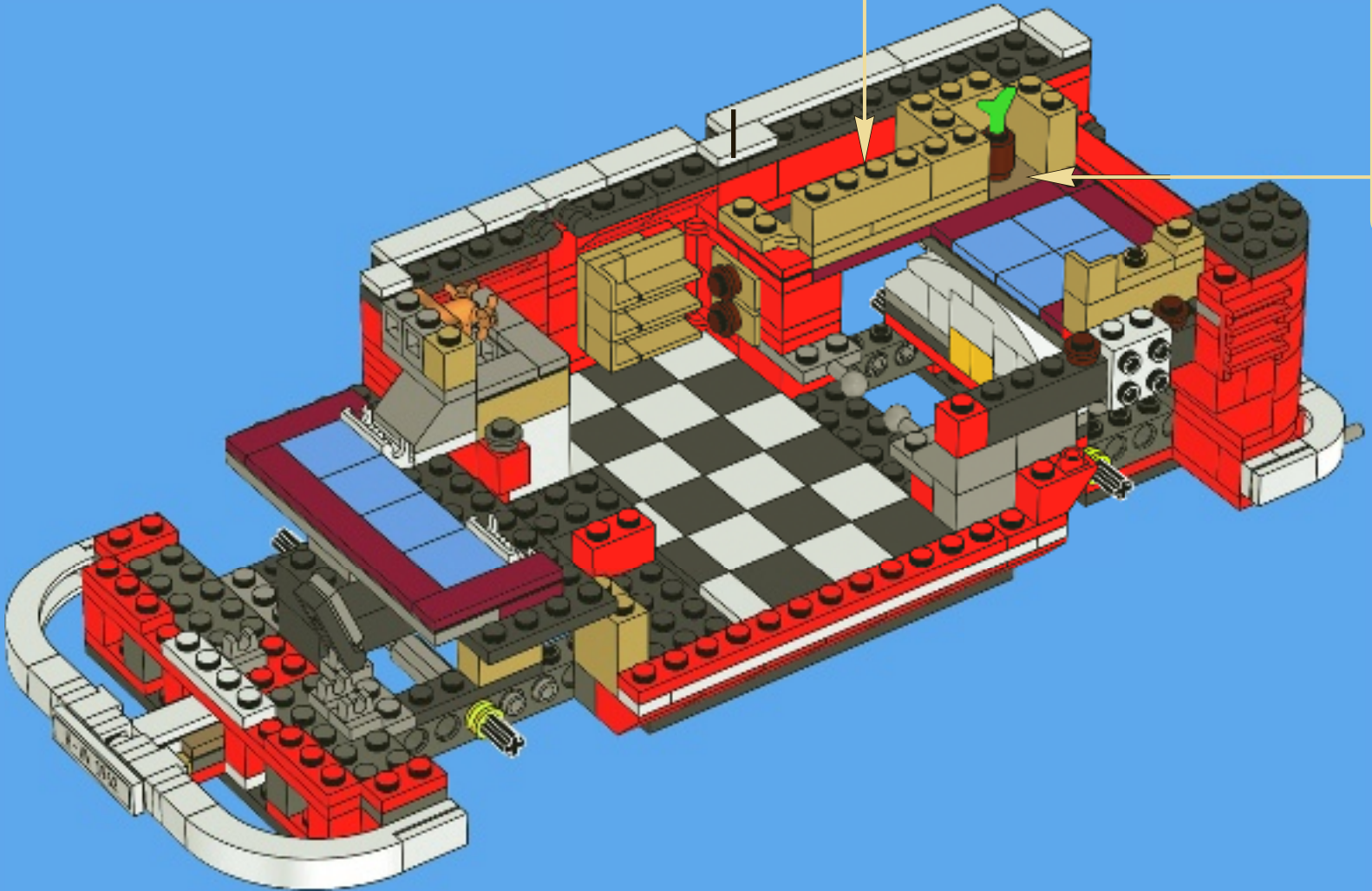



55

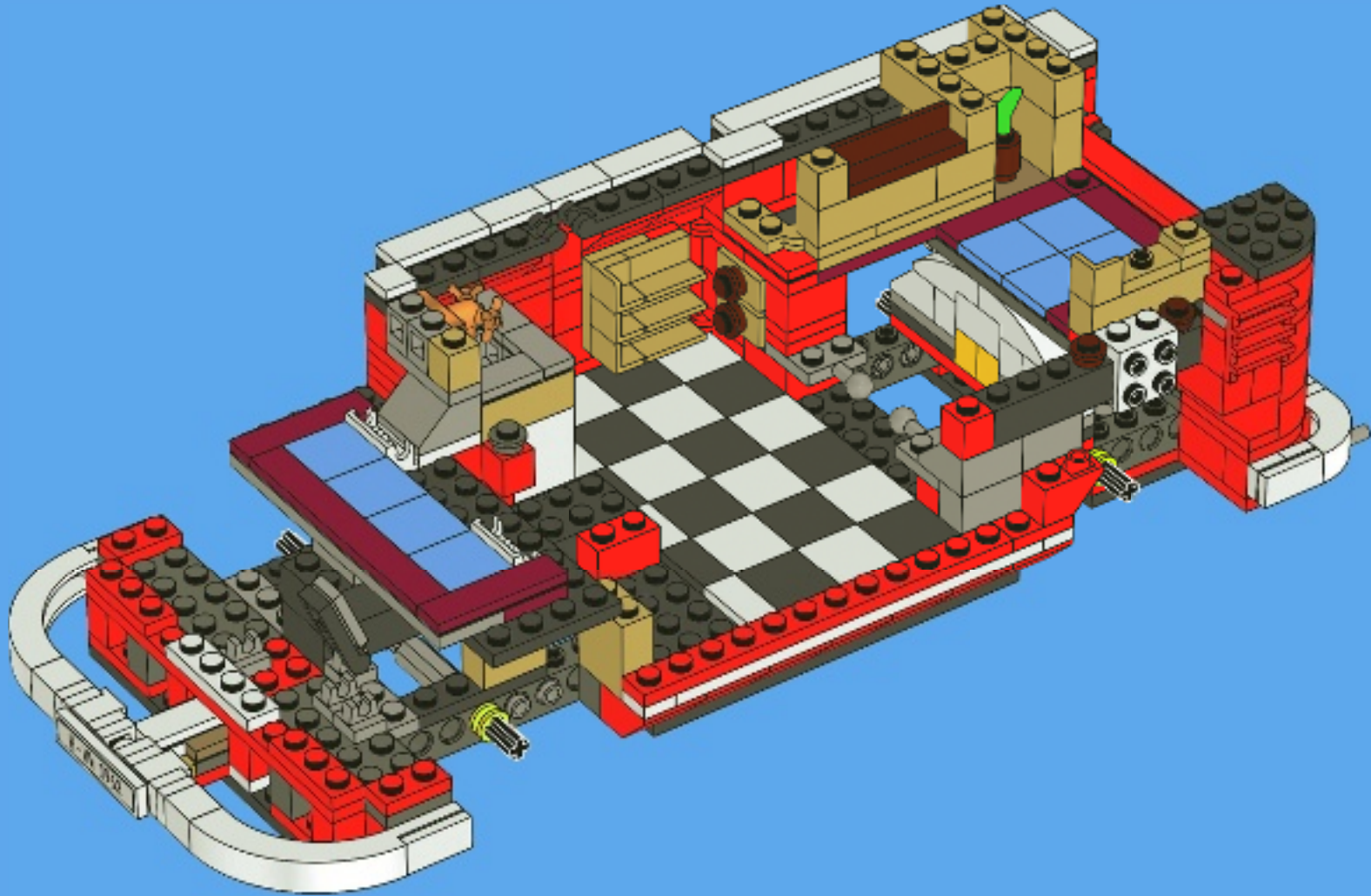

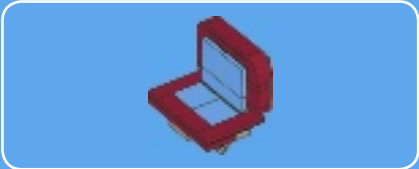

1

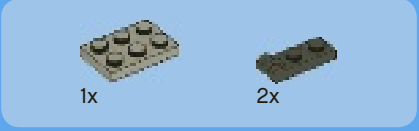

2

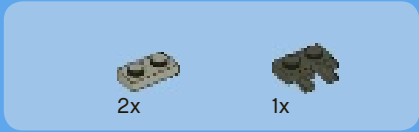

3



4

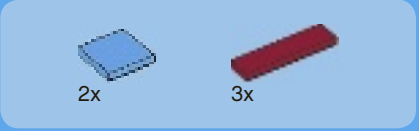

5





6

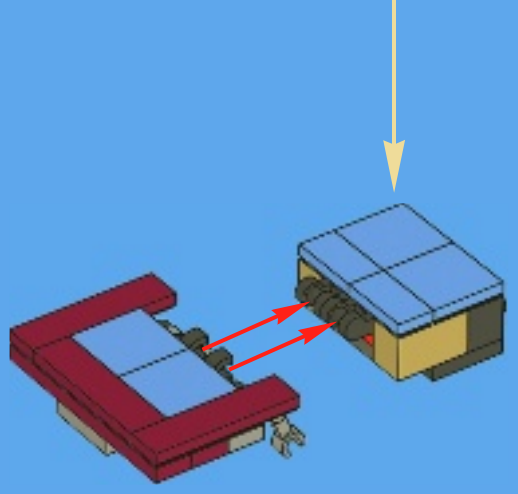
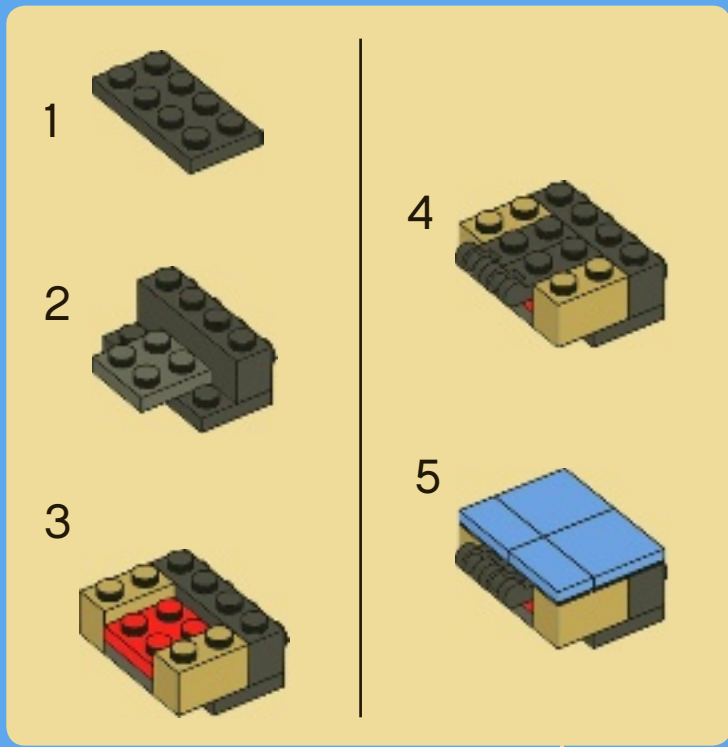

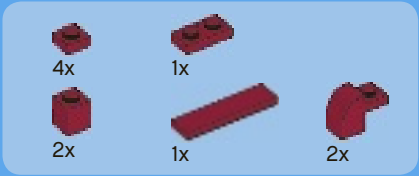

7

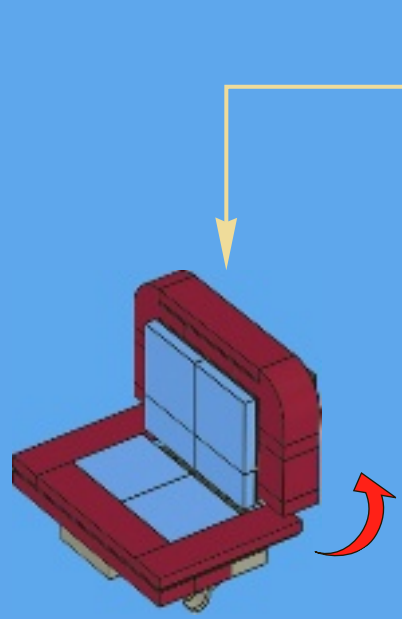
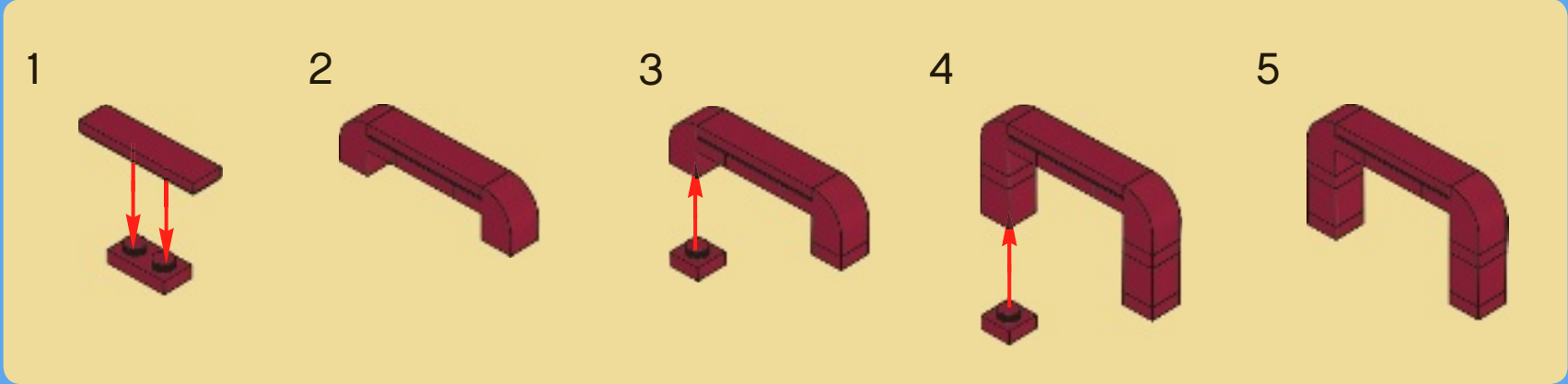

56

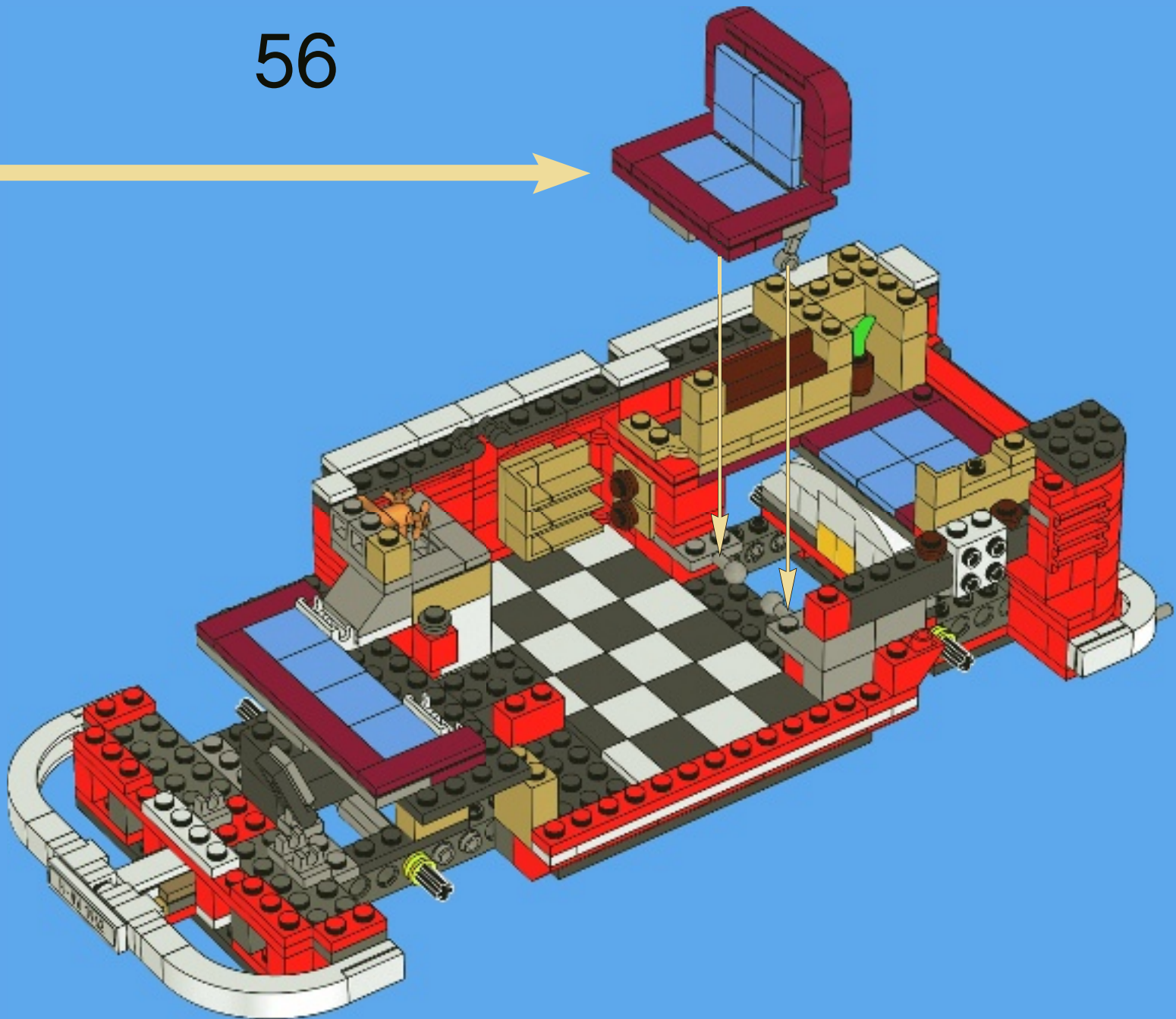

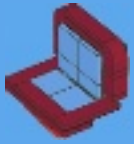

1x

1



1x



1x

2



2x



1x

3



2x

4

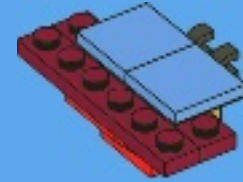

3x

5

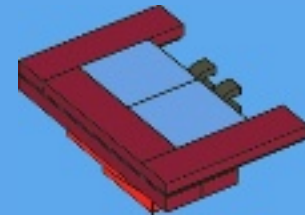



6

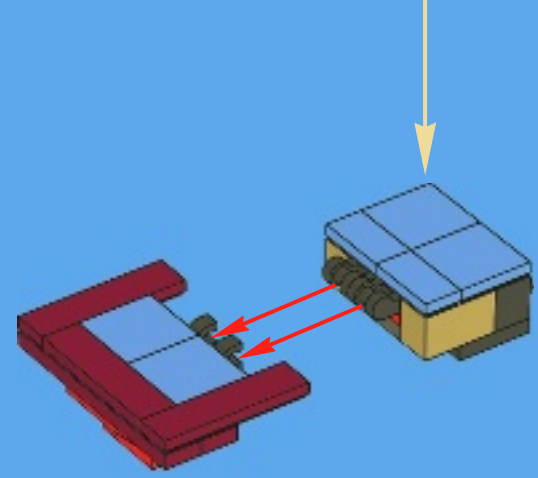
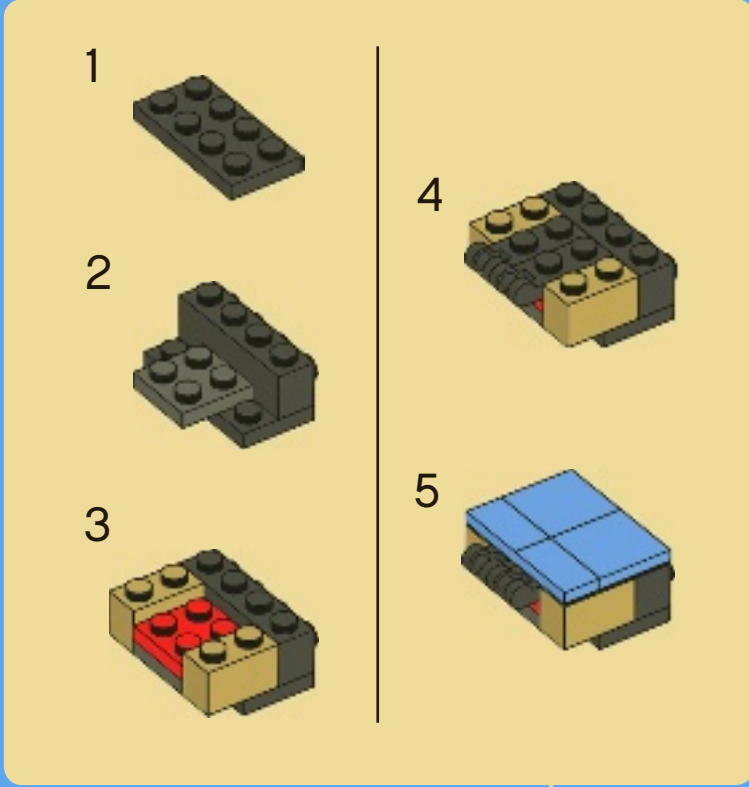

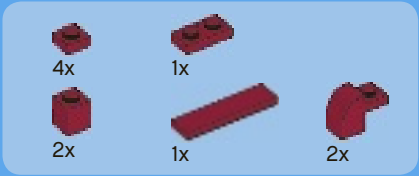

7

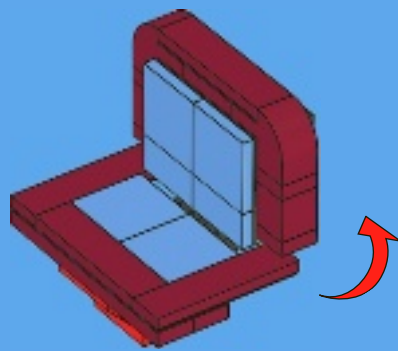
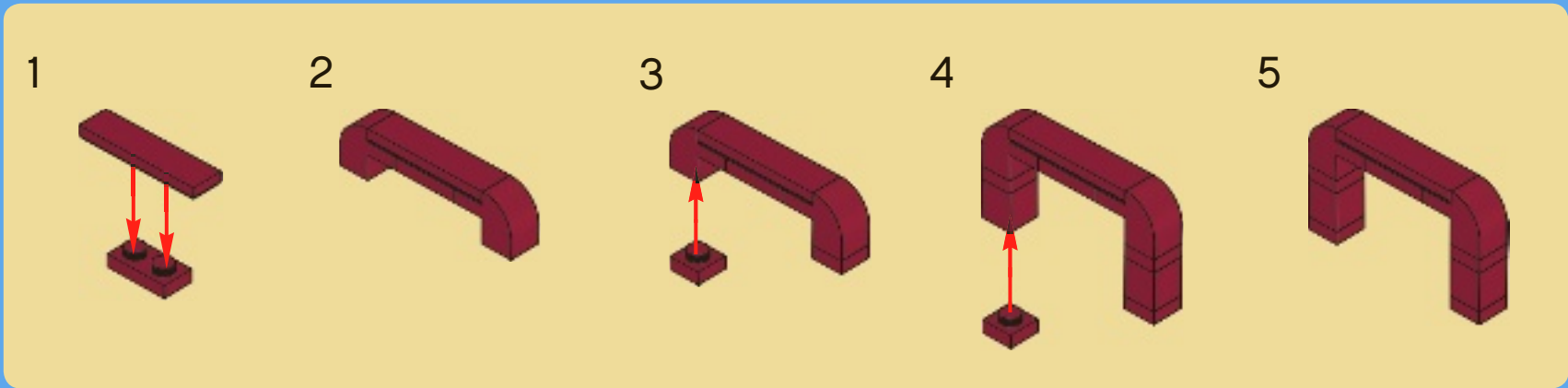

57

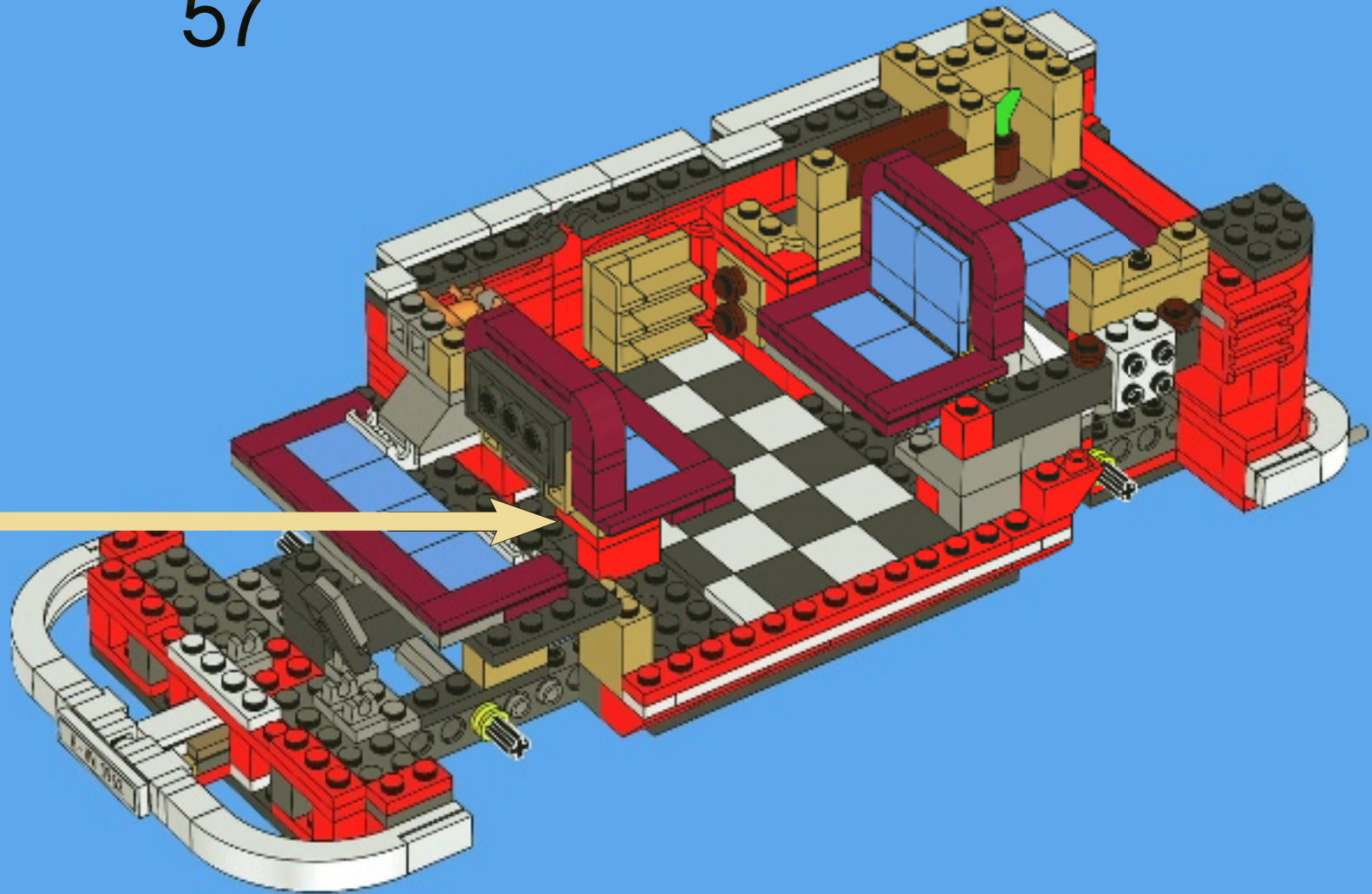



2x



1x



1x

58

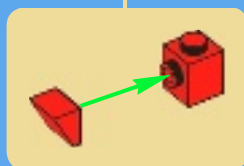
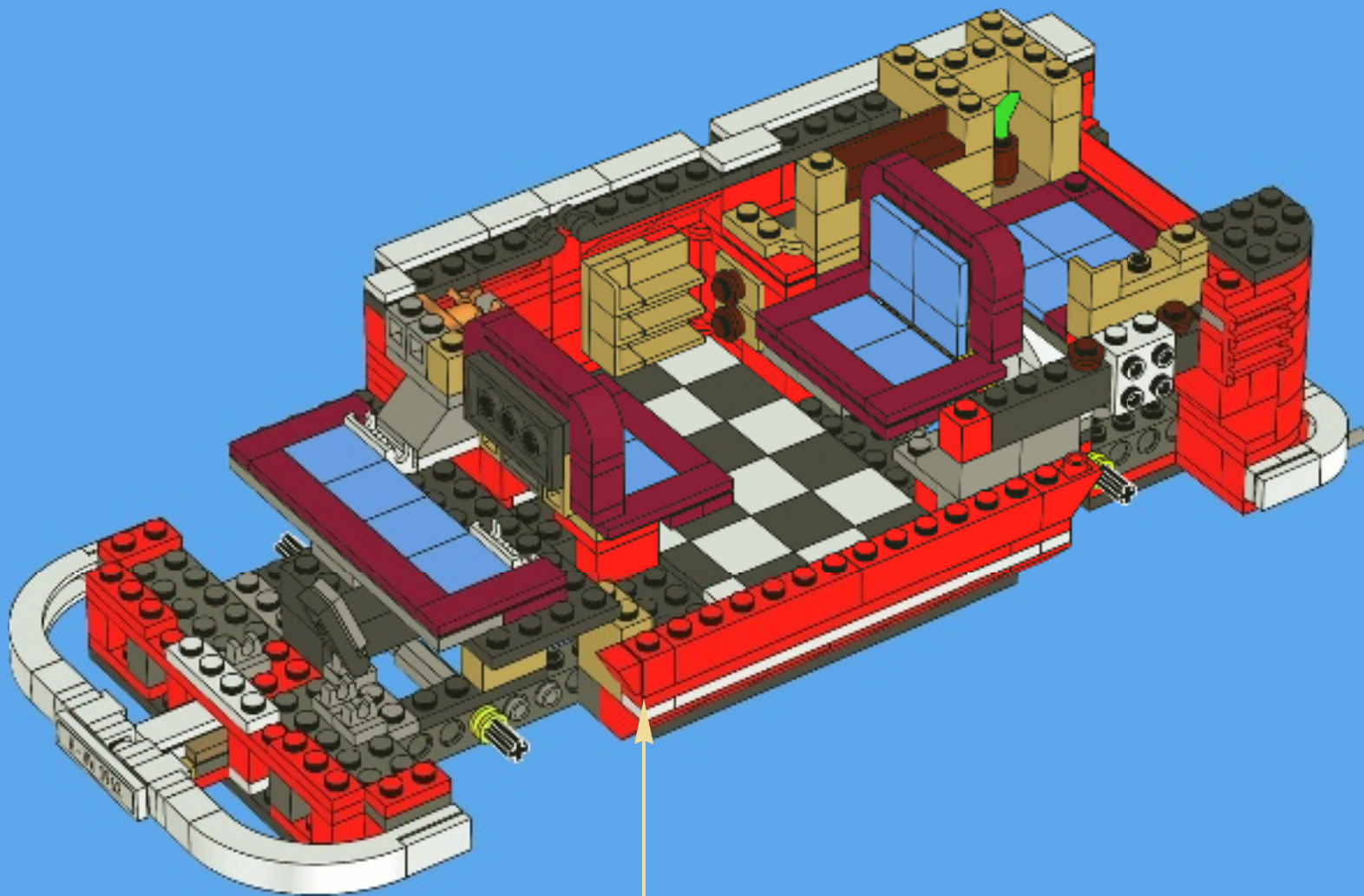



2x



1x



1x

59

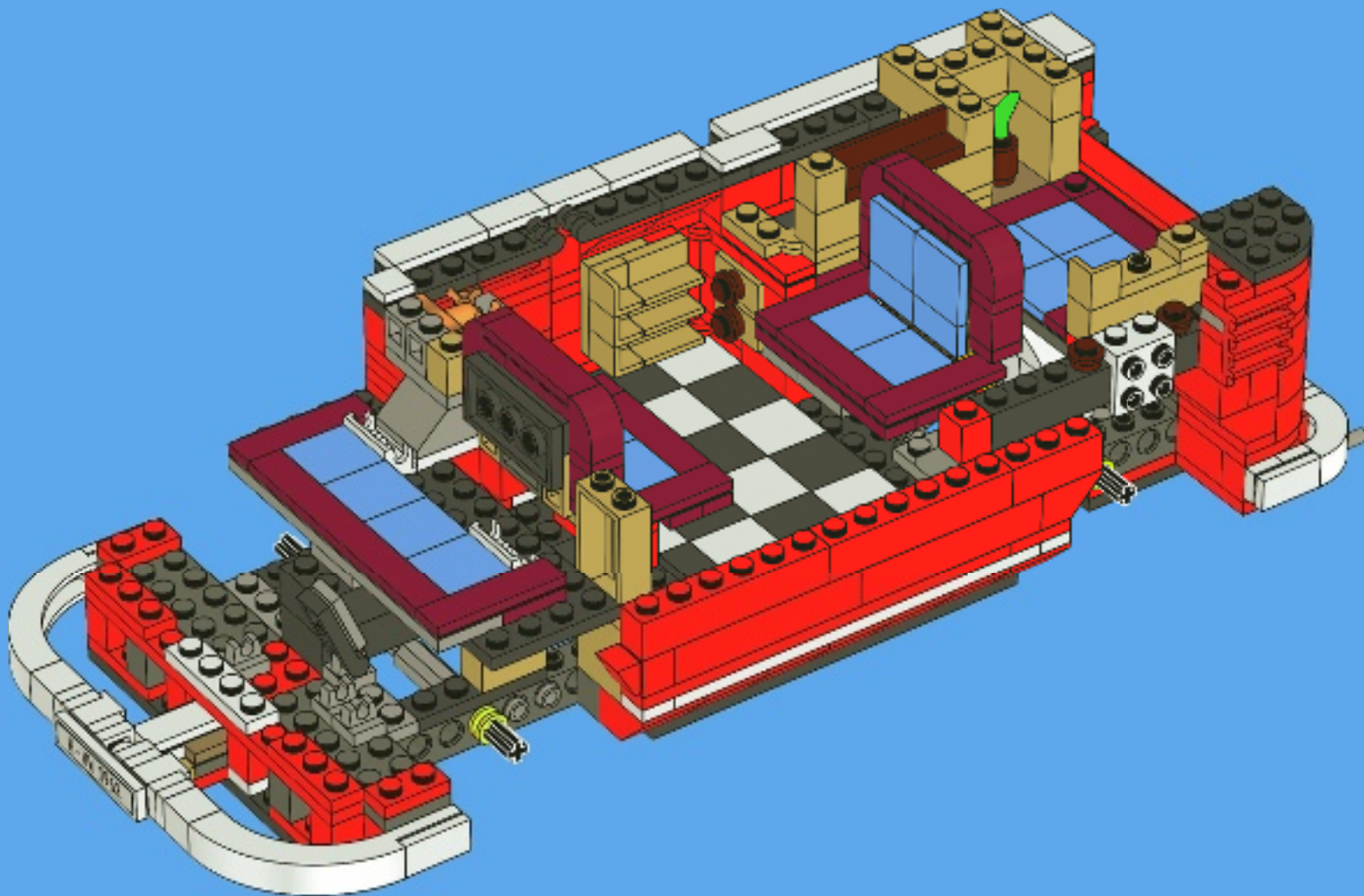



2x



1x

60

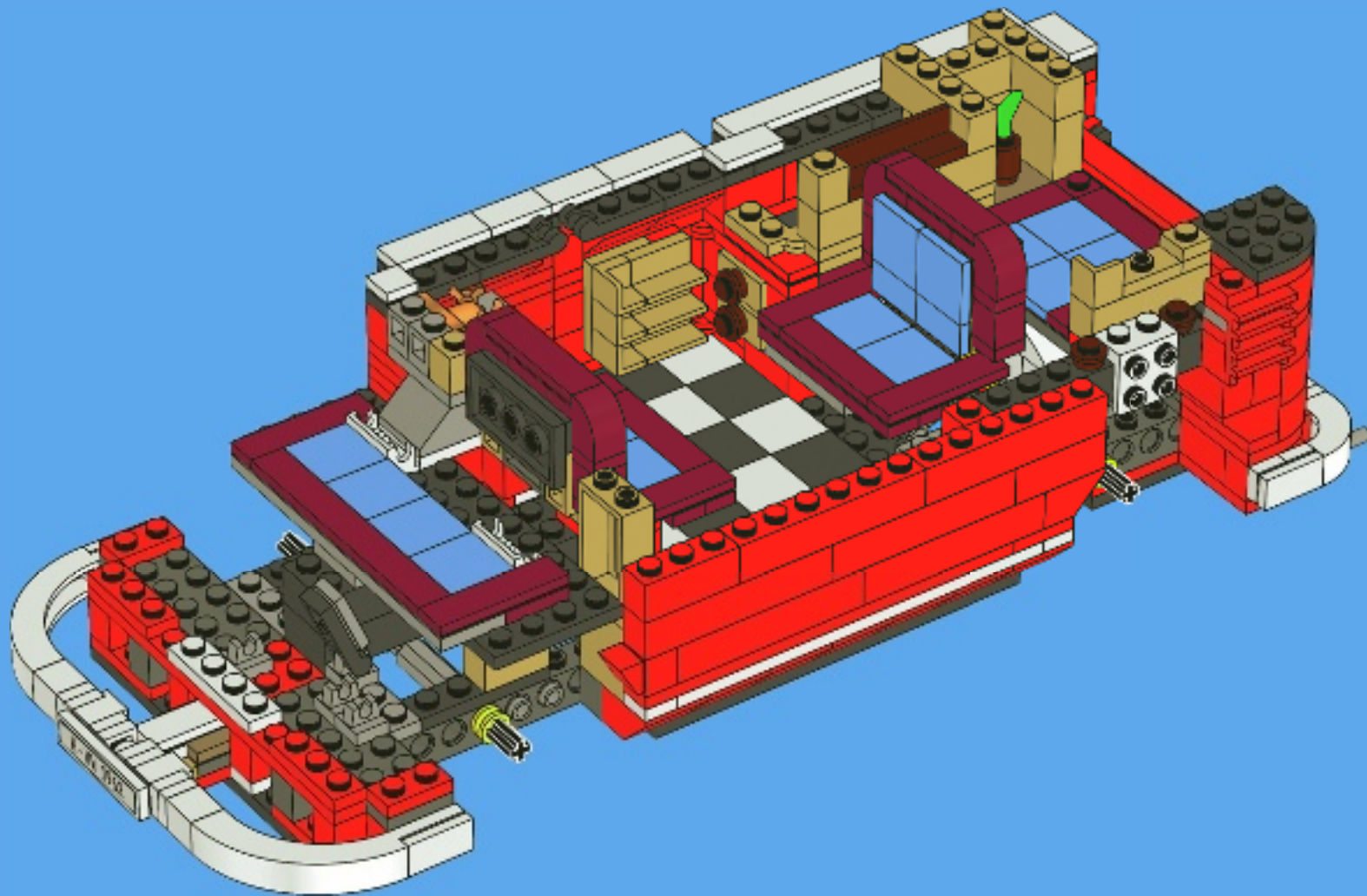

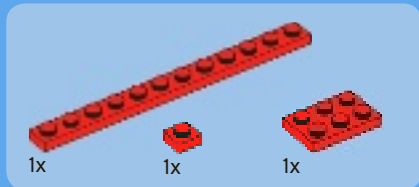

61

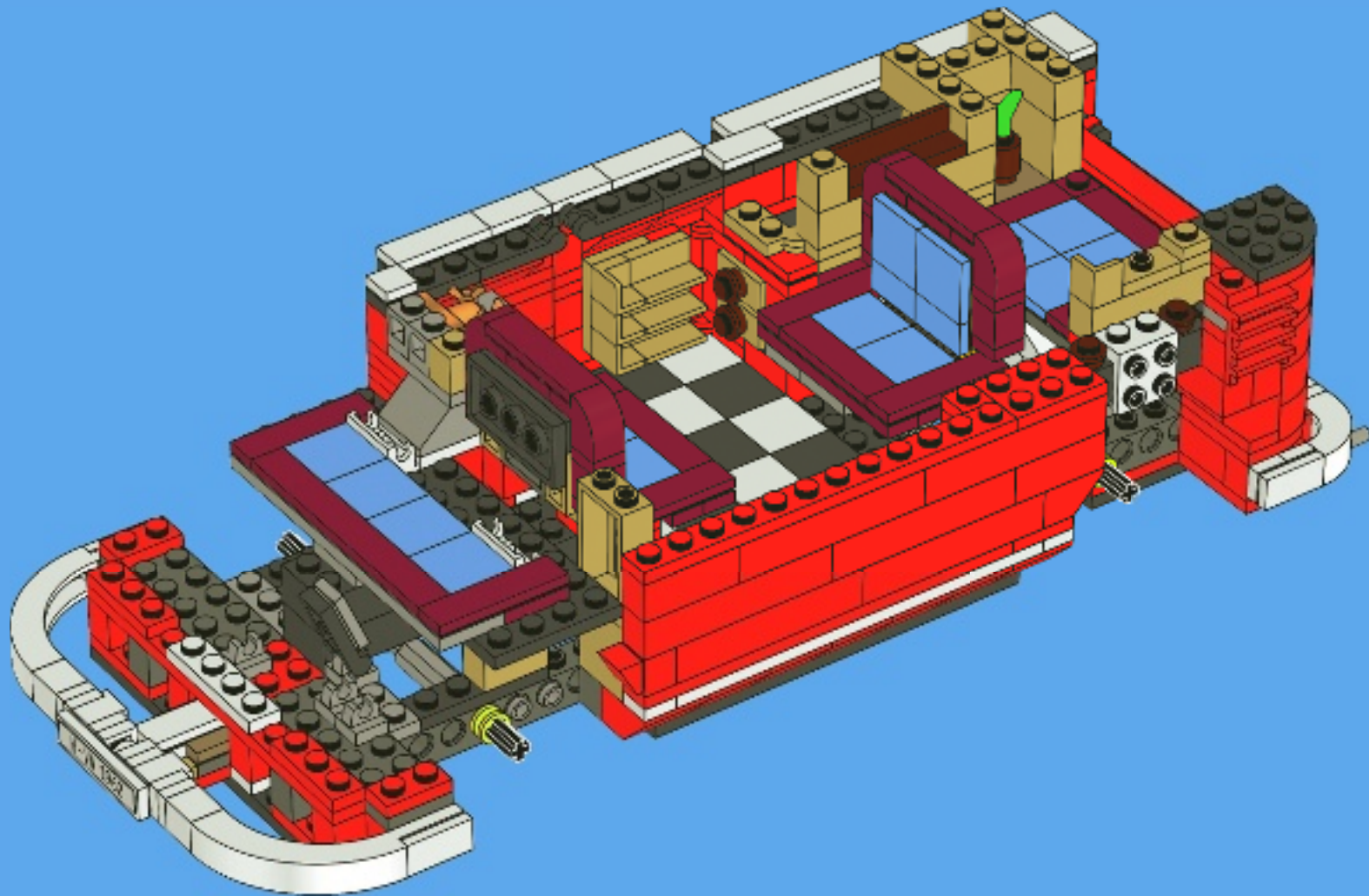



1x



1x



1x

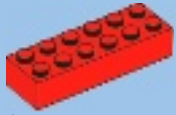

2x



1x

62

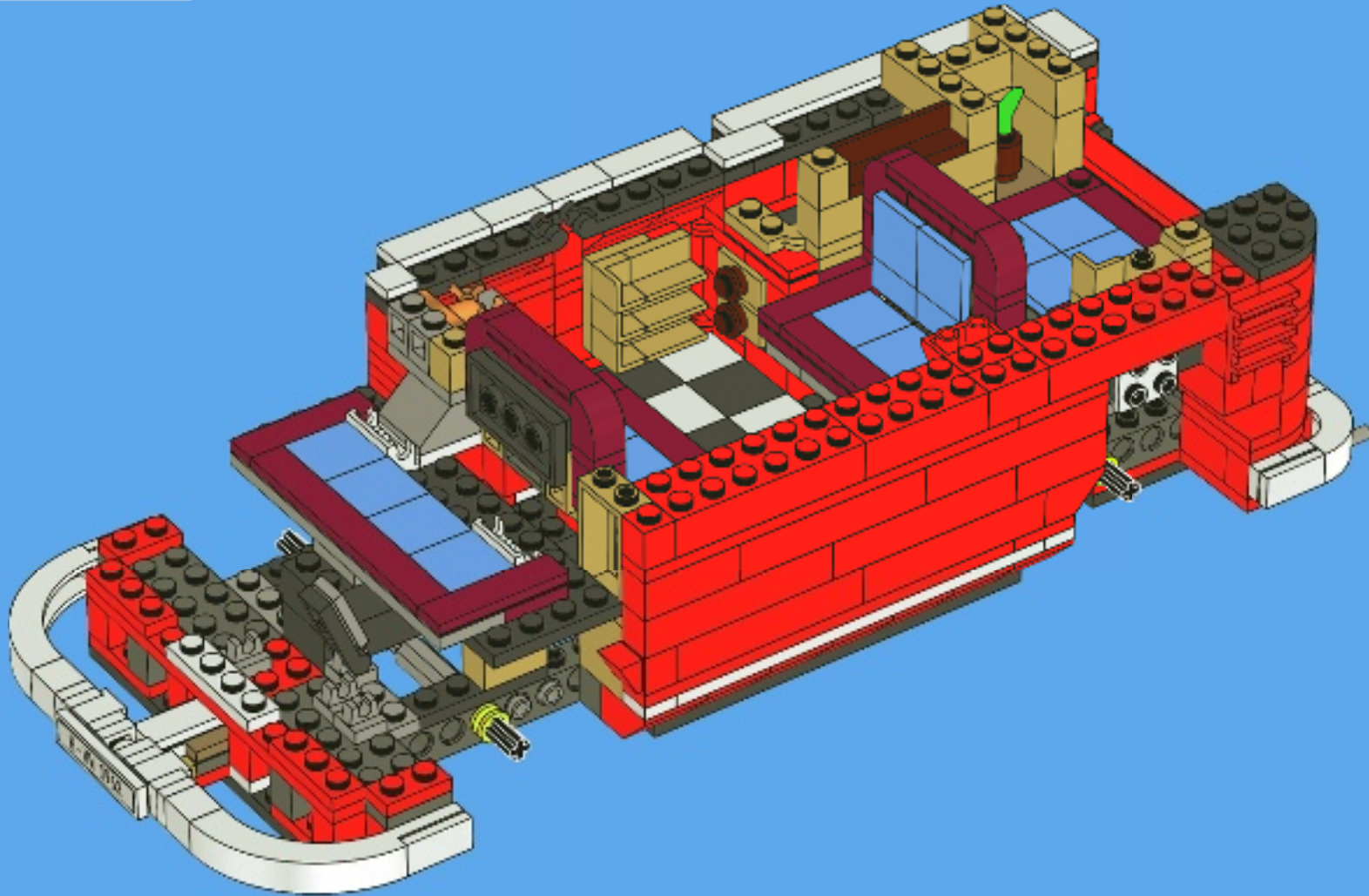



63

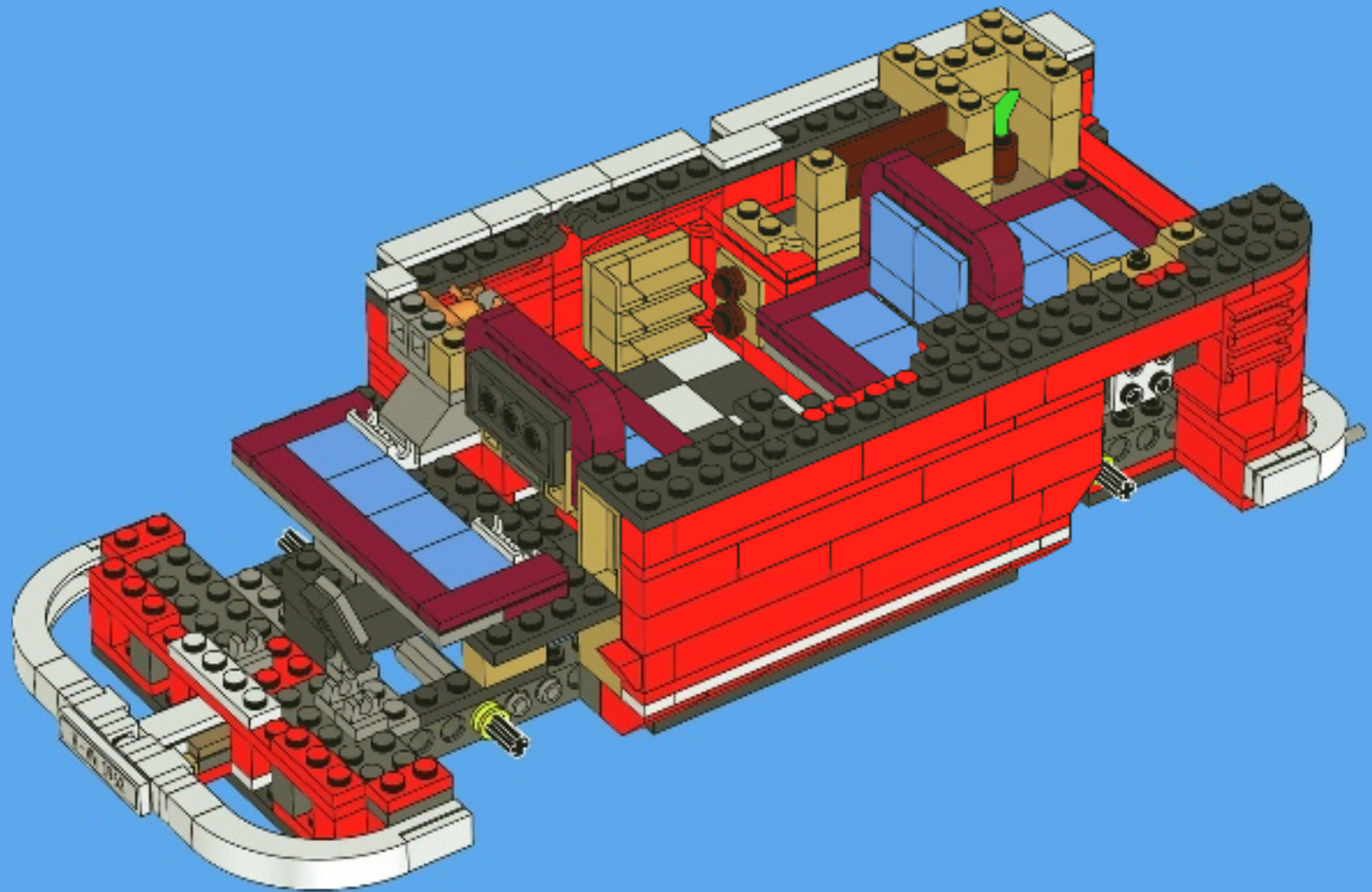

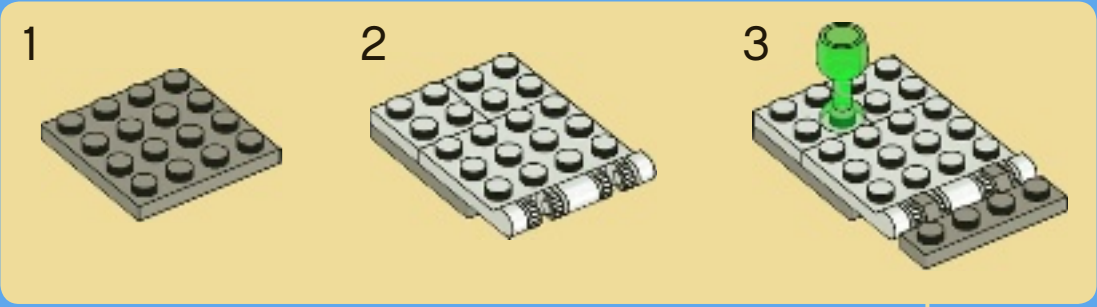
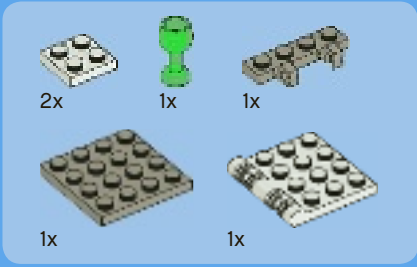

64

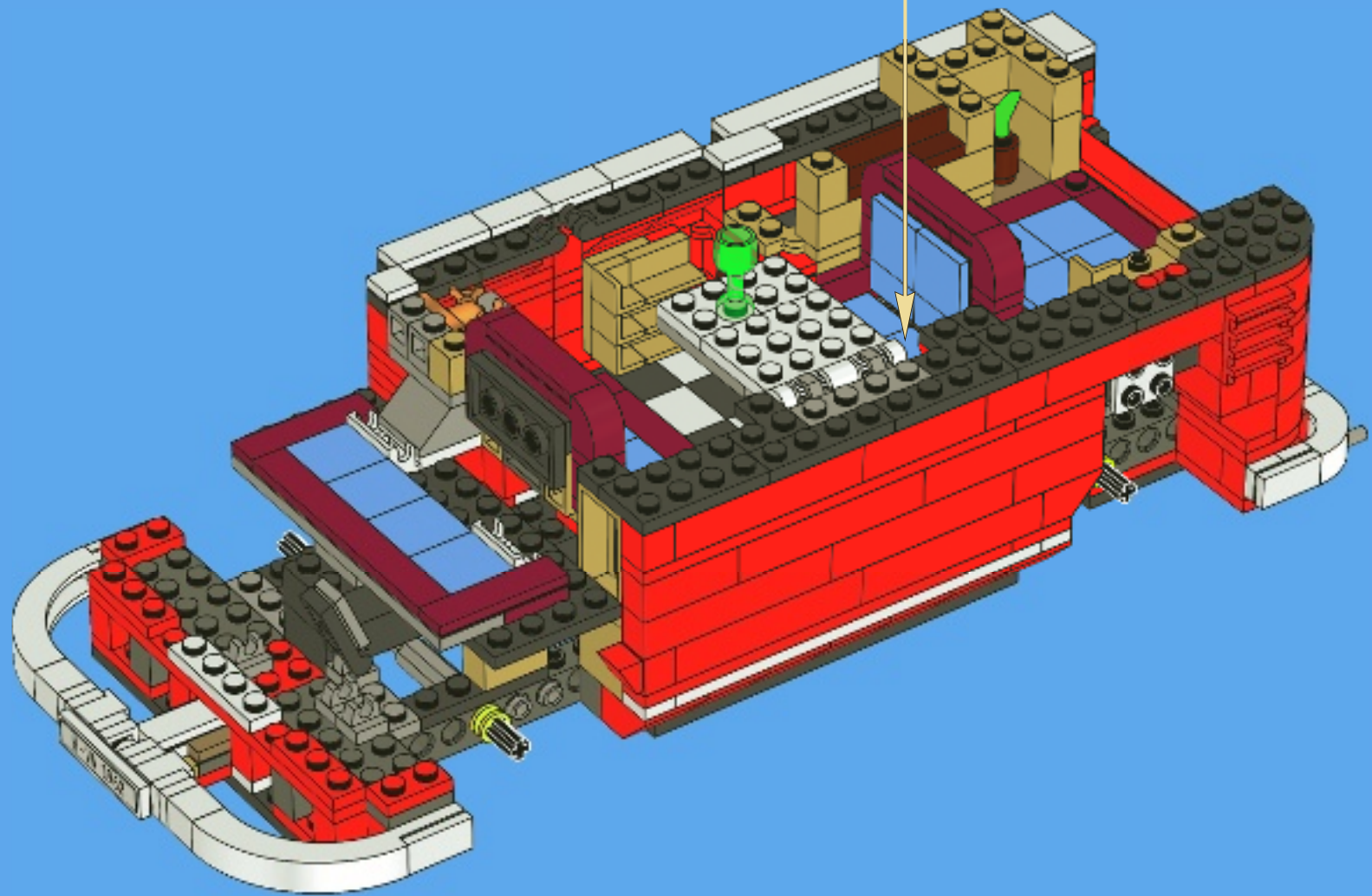

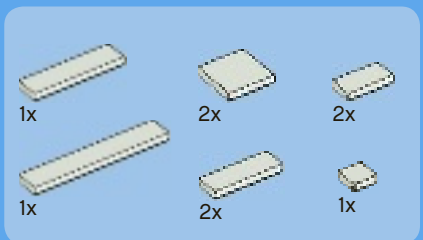

65

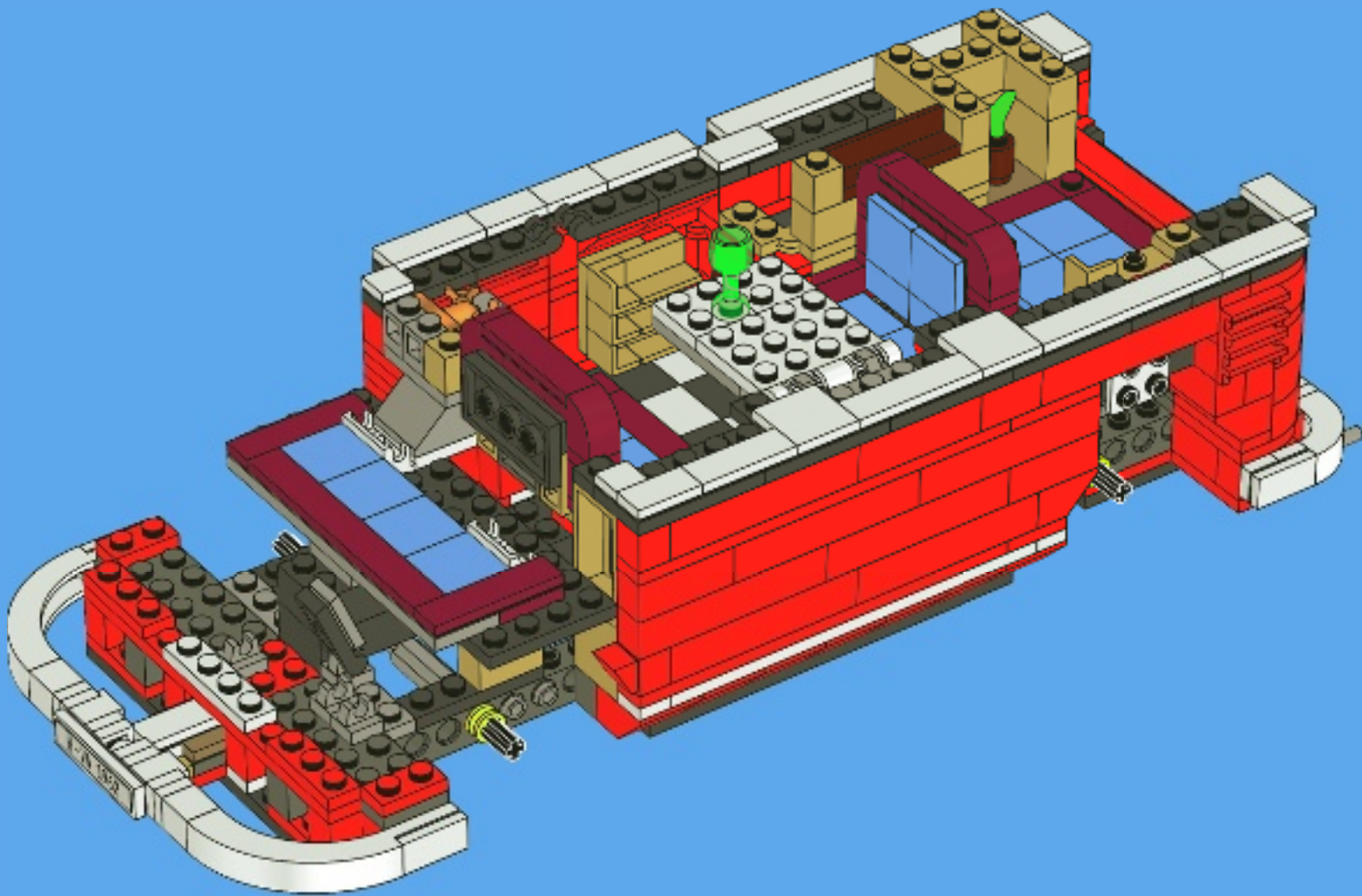



66

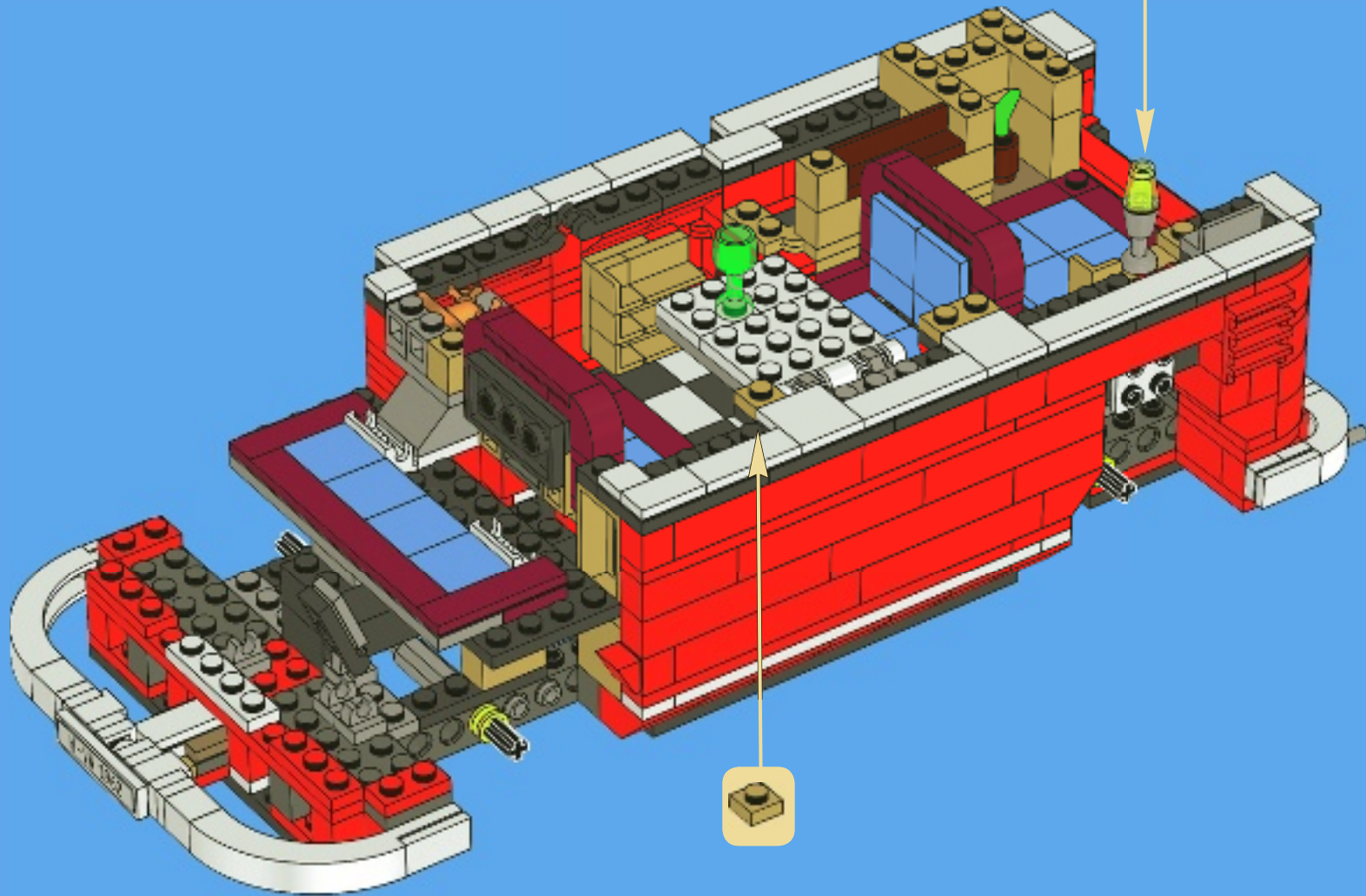

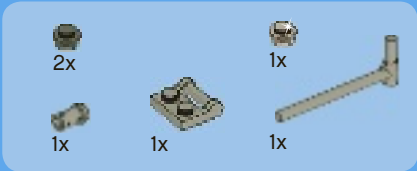

67

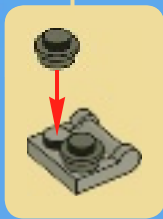
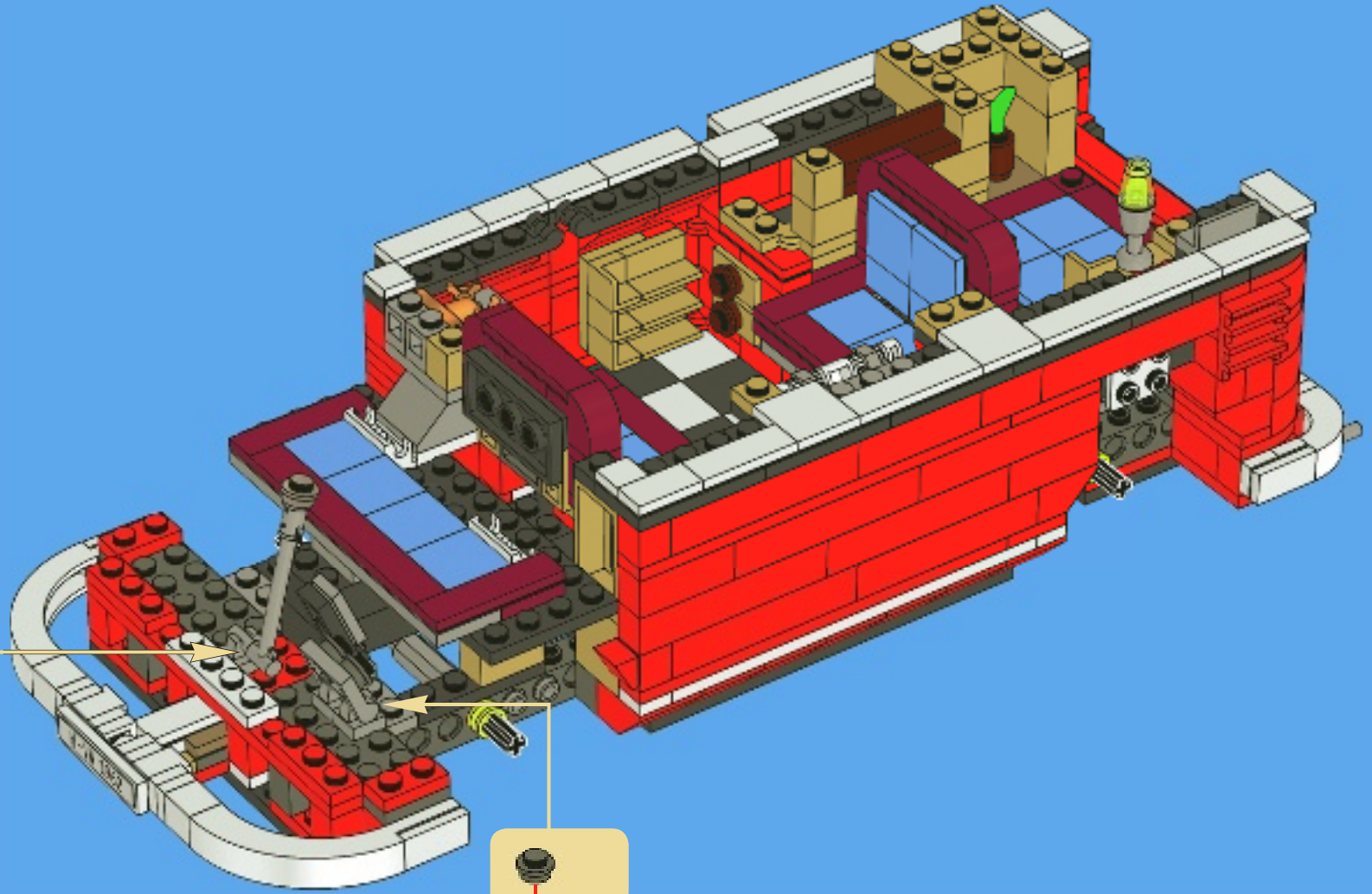
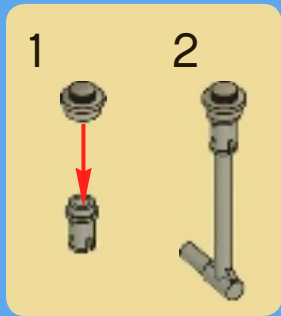

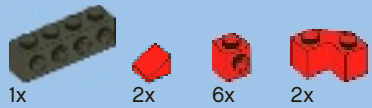

68

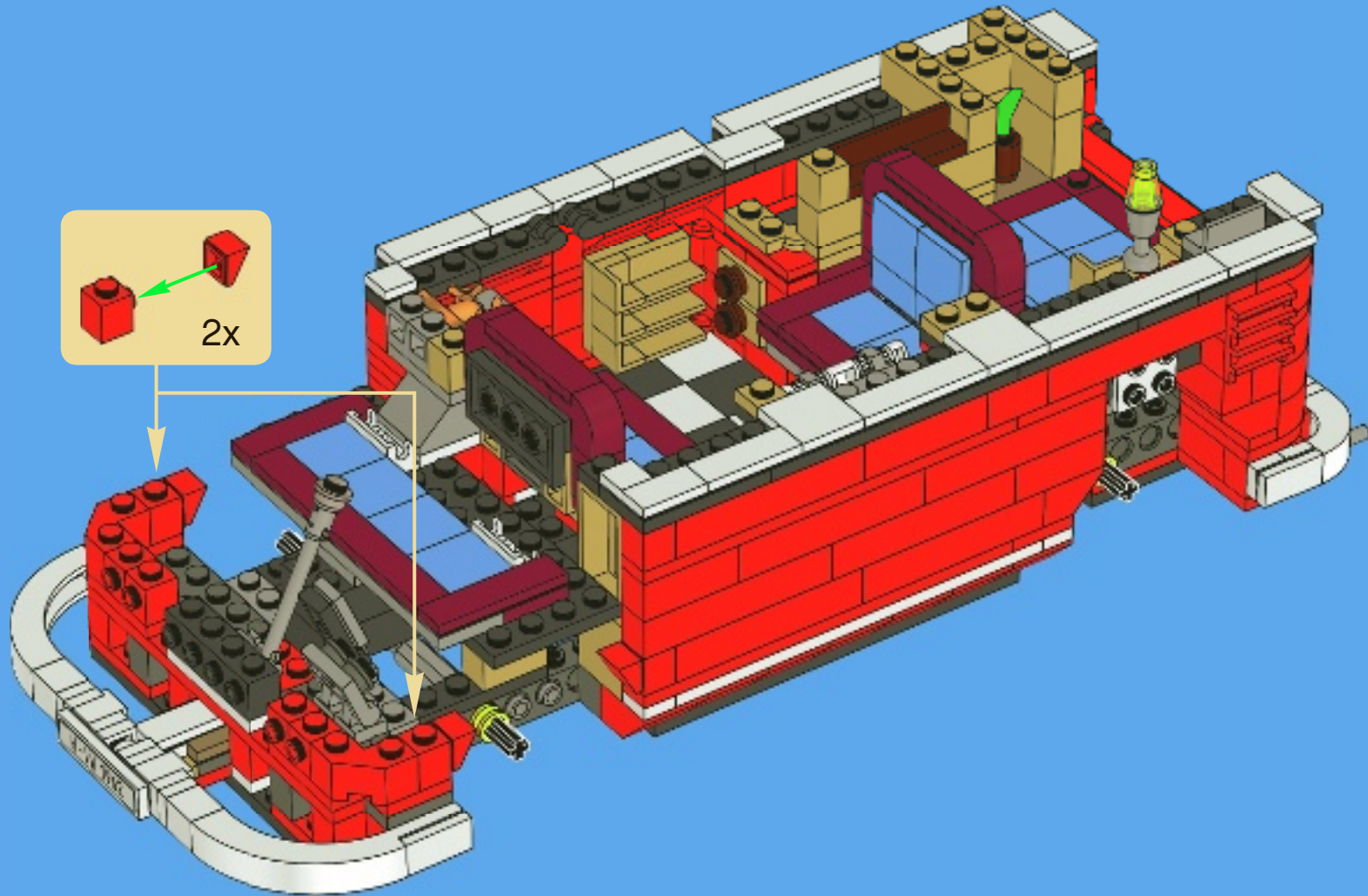



69

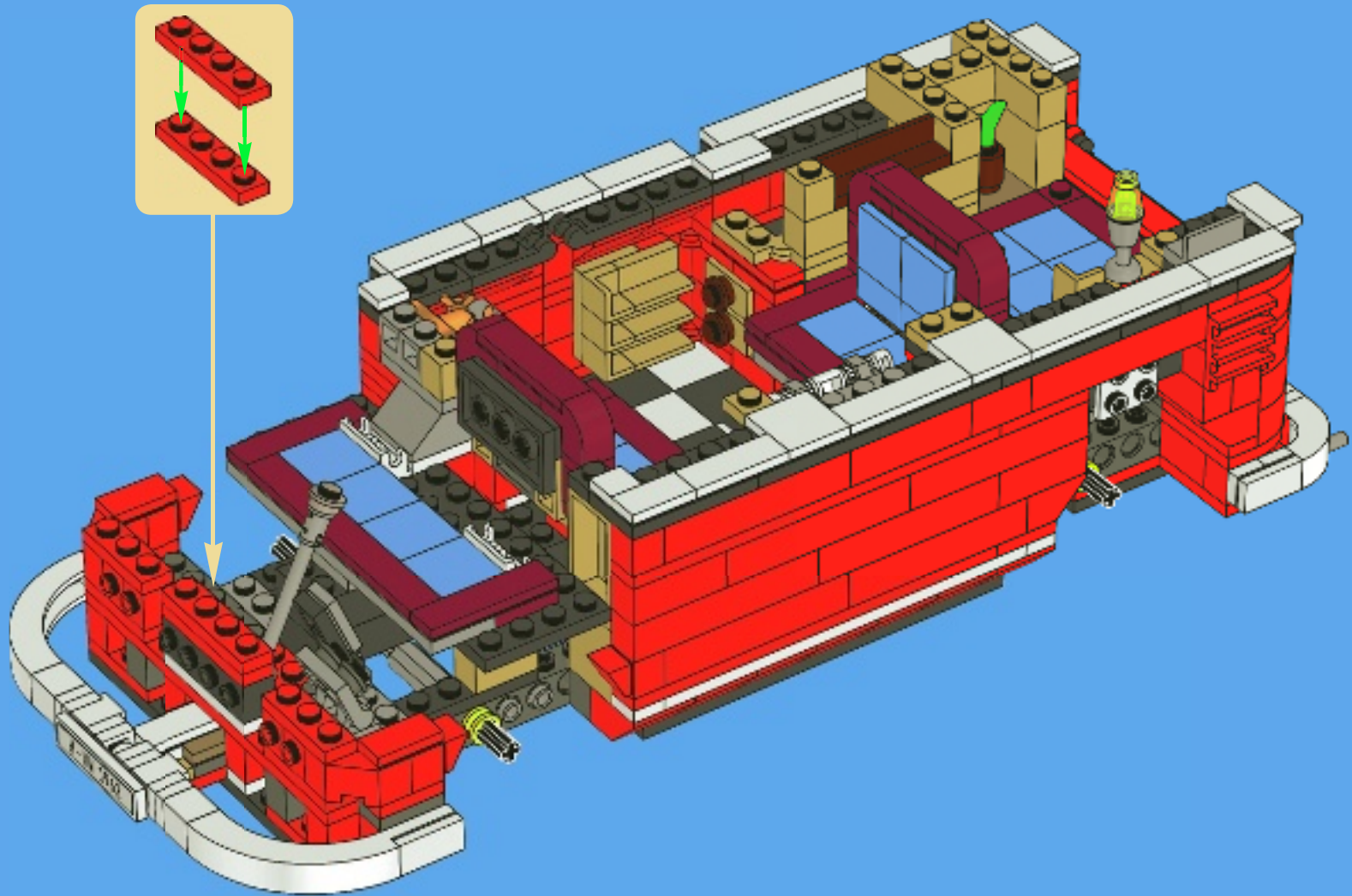



2x



1x

70

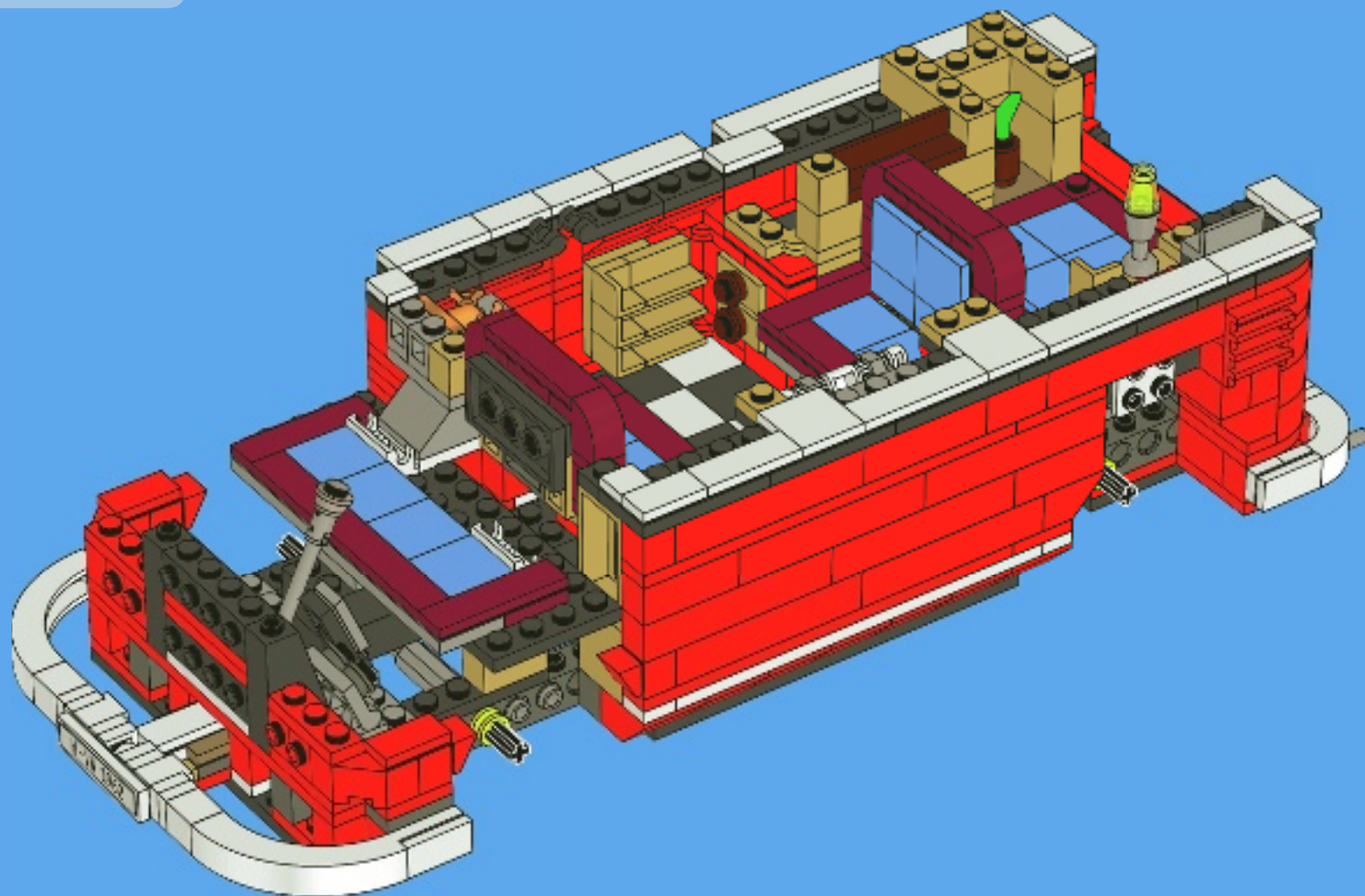

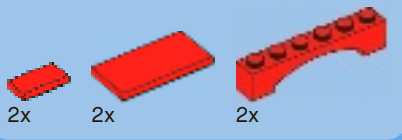

71

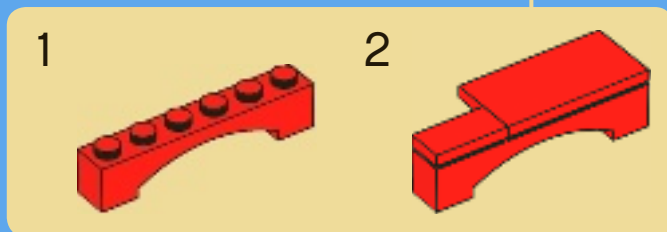
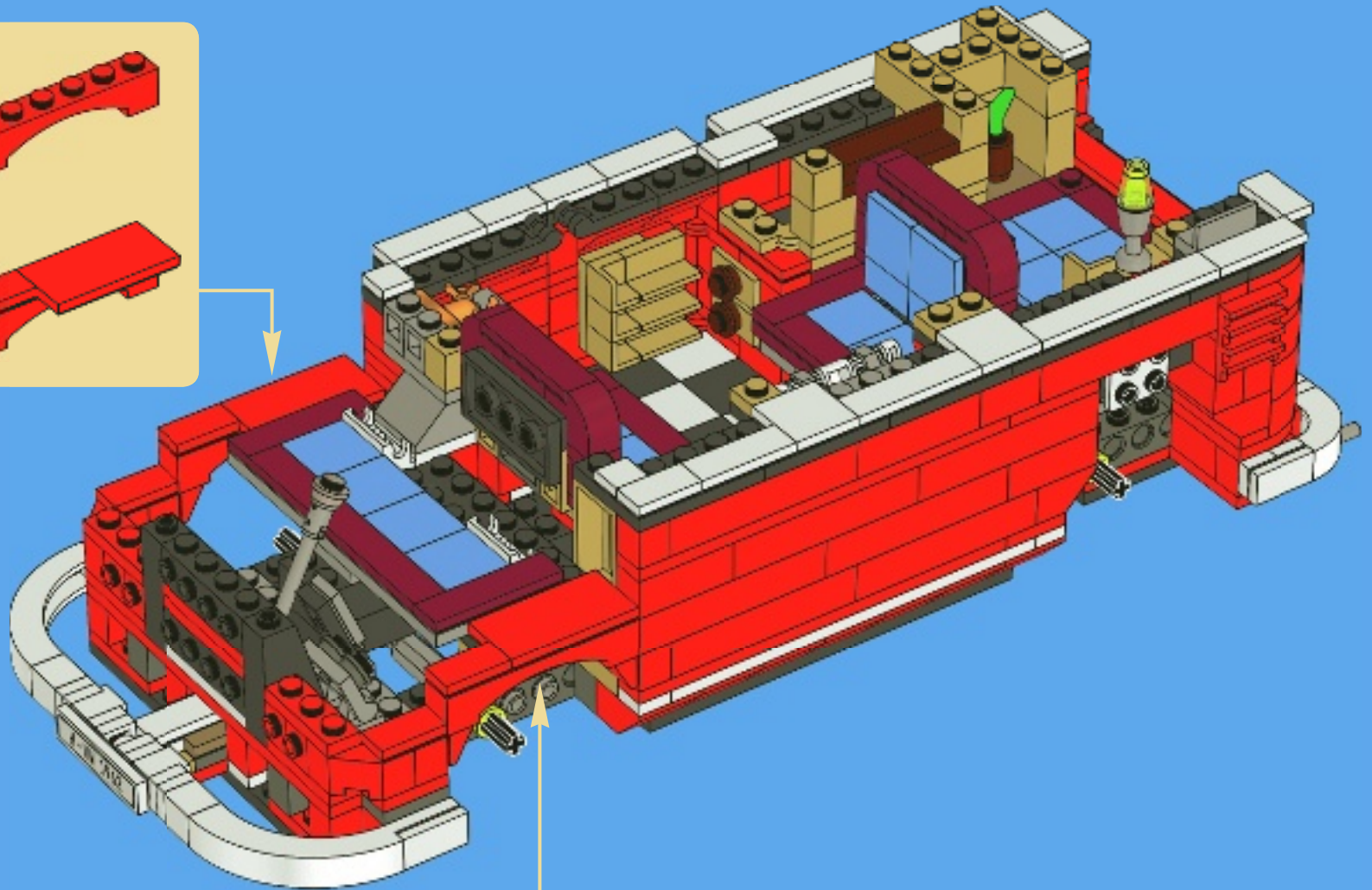
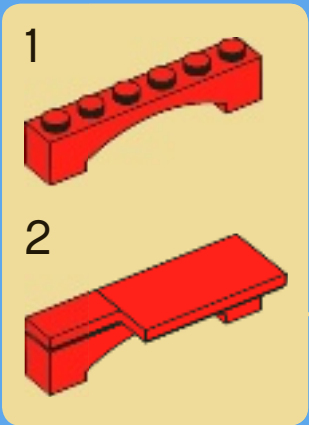



2x



2x



2x

72

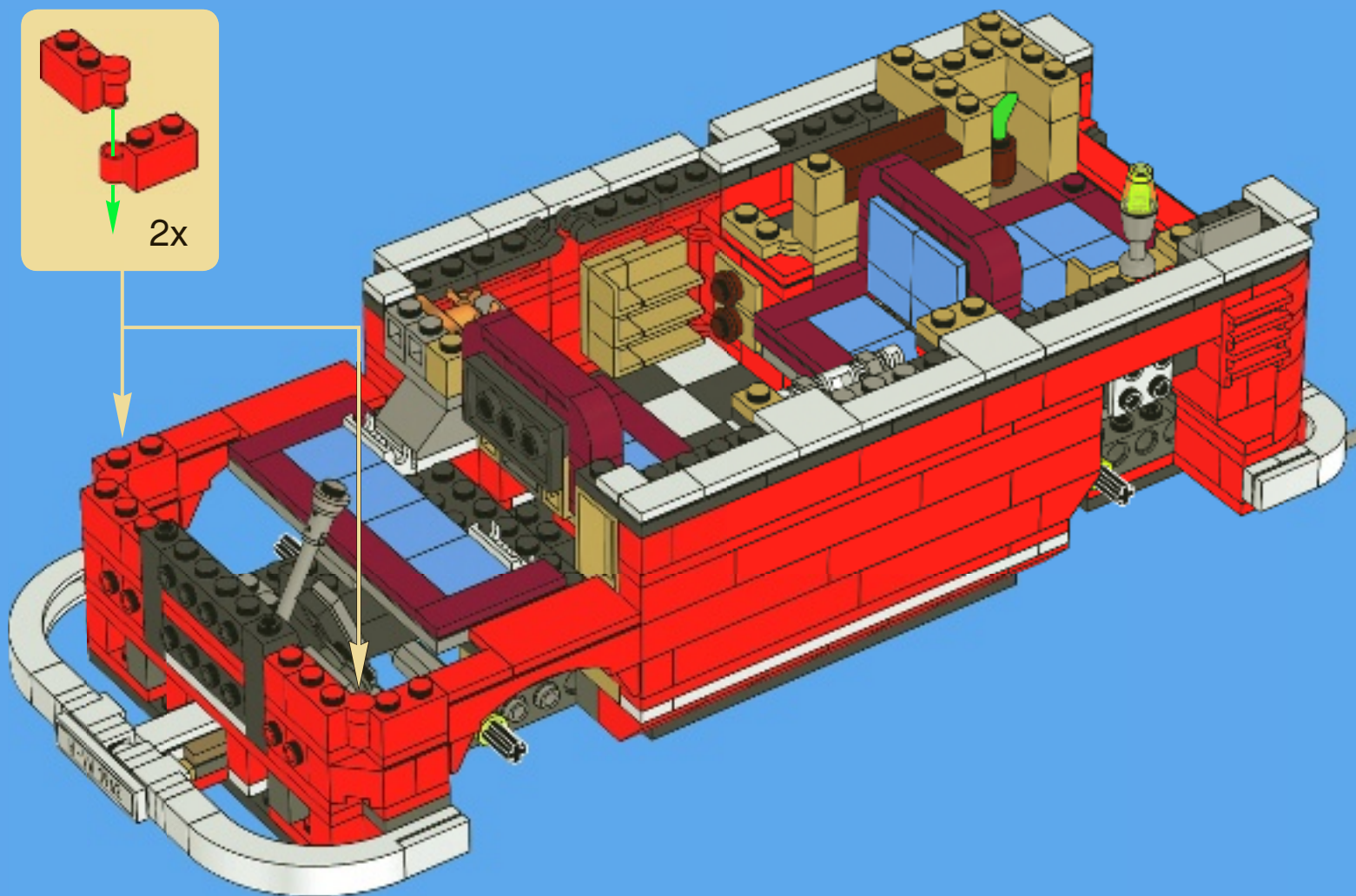
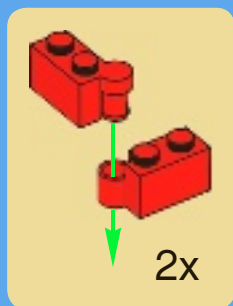

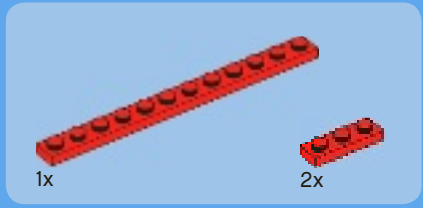

73

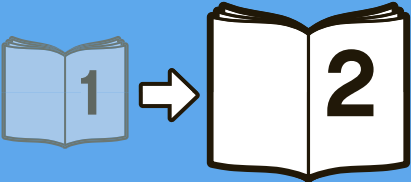
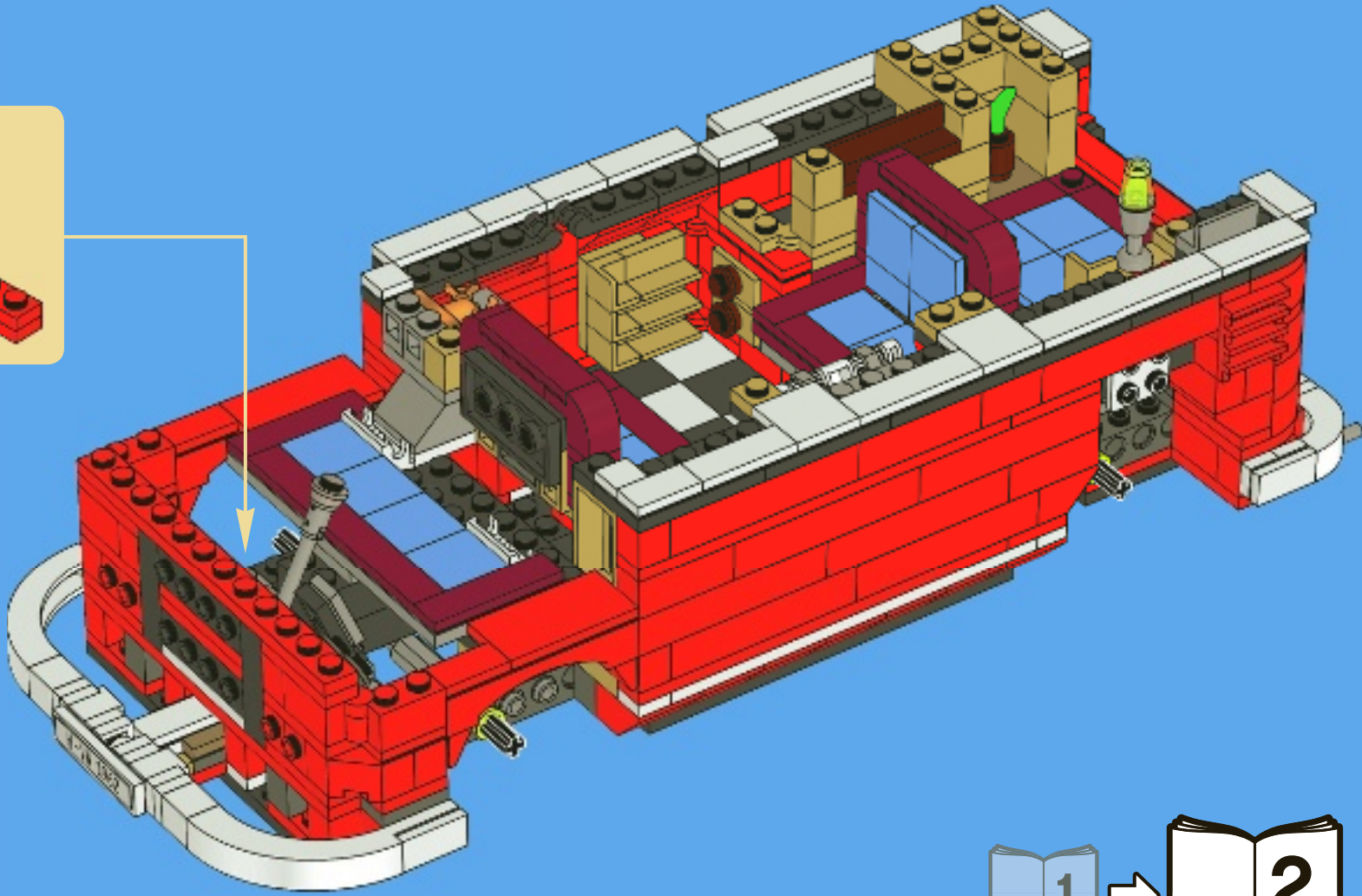
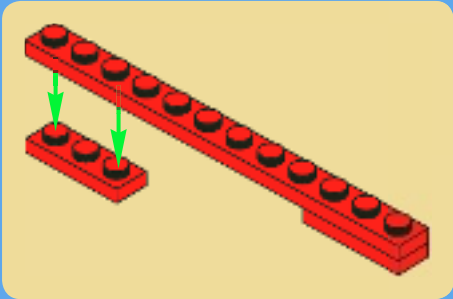

10197

10218

10211





10220



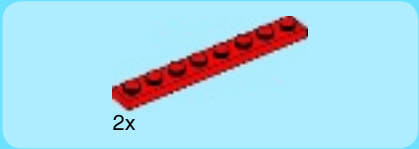

1

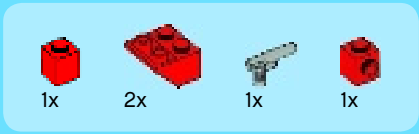
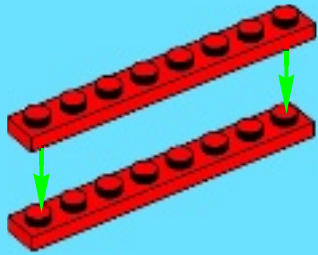

2

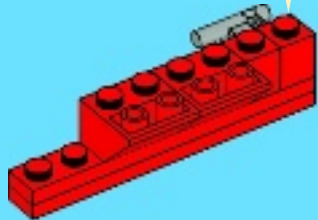
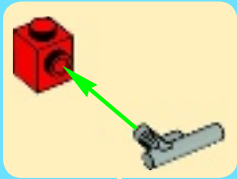

3

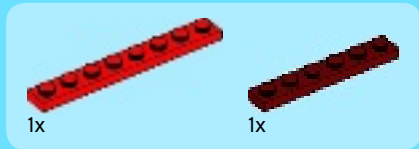
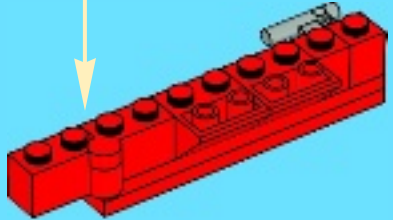
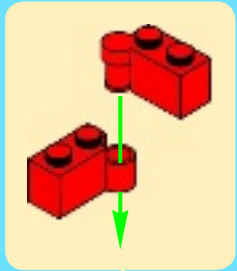

4

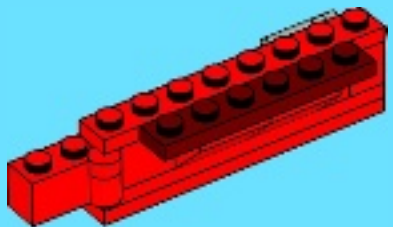



5

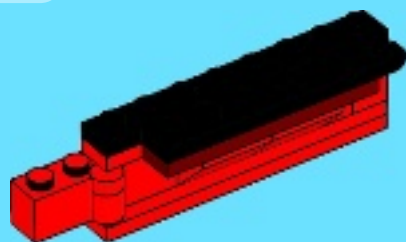

6

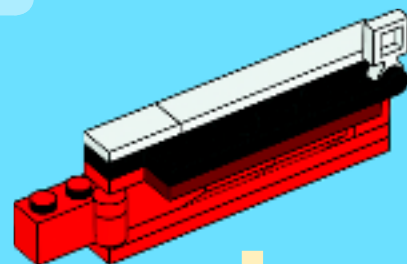

74

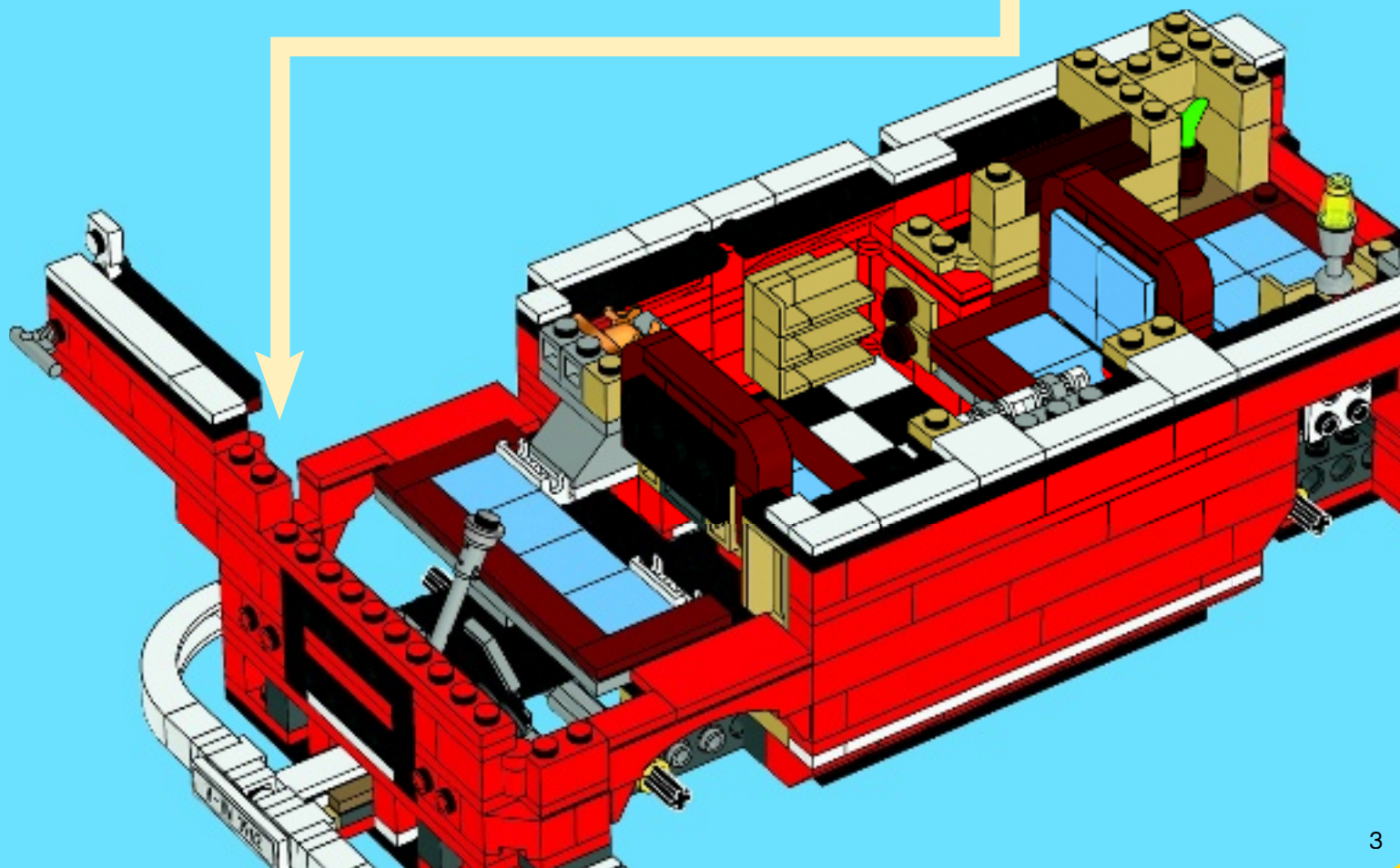

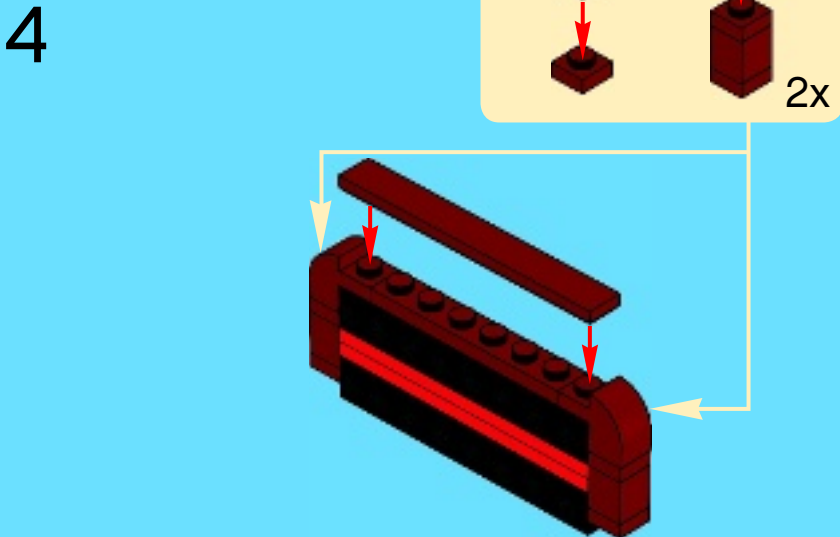
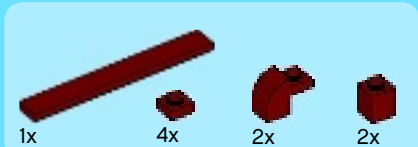
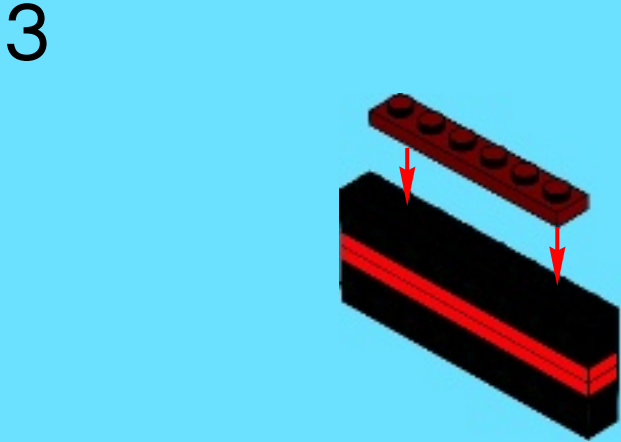
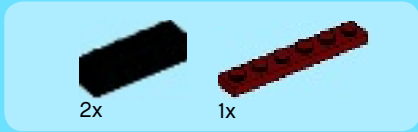
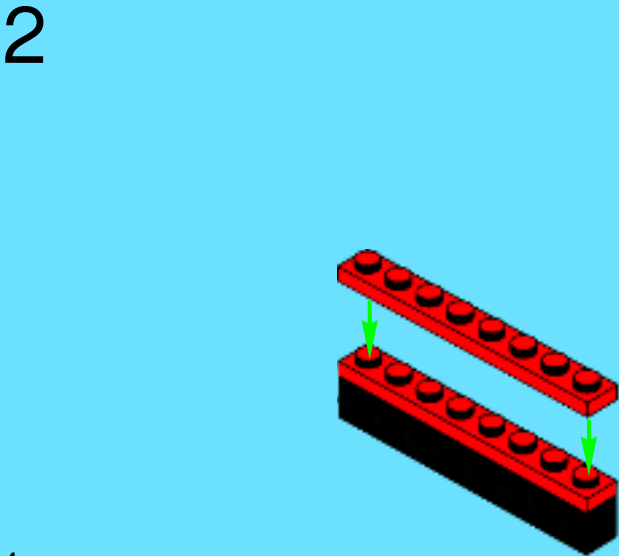
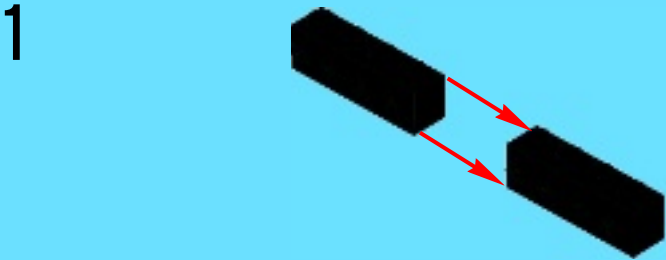
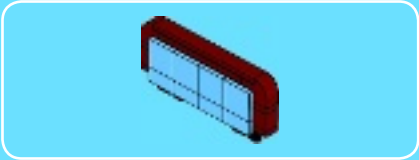



4x



4x

5

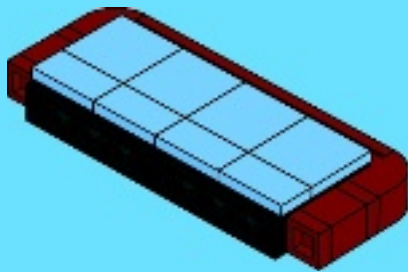

2x

6

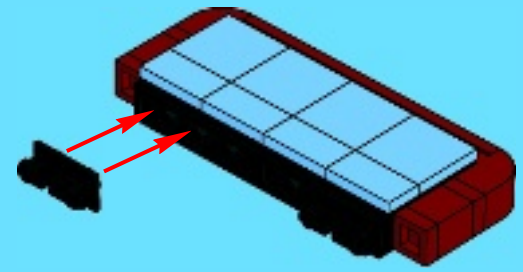

75

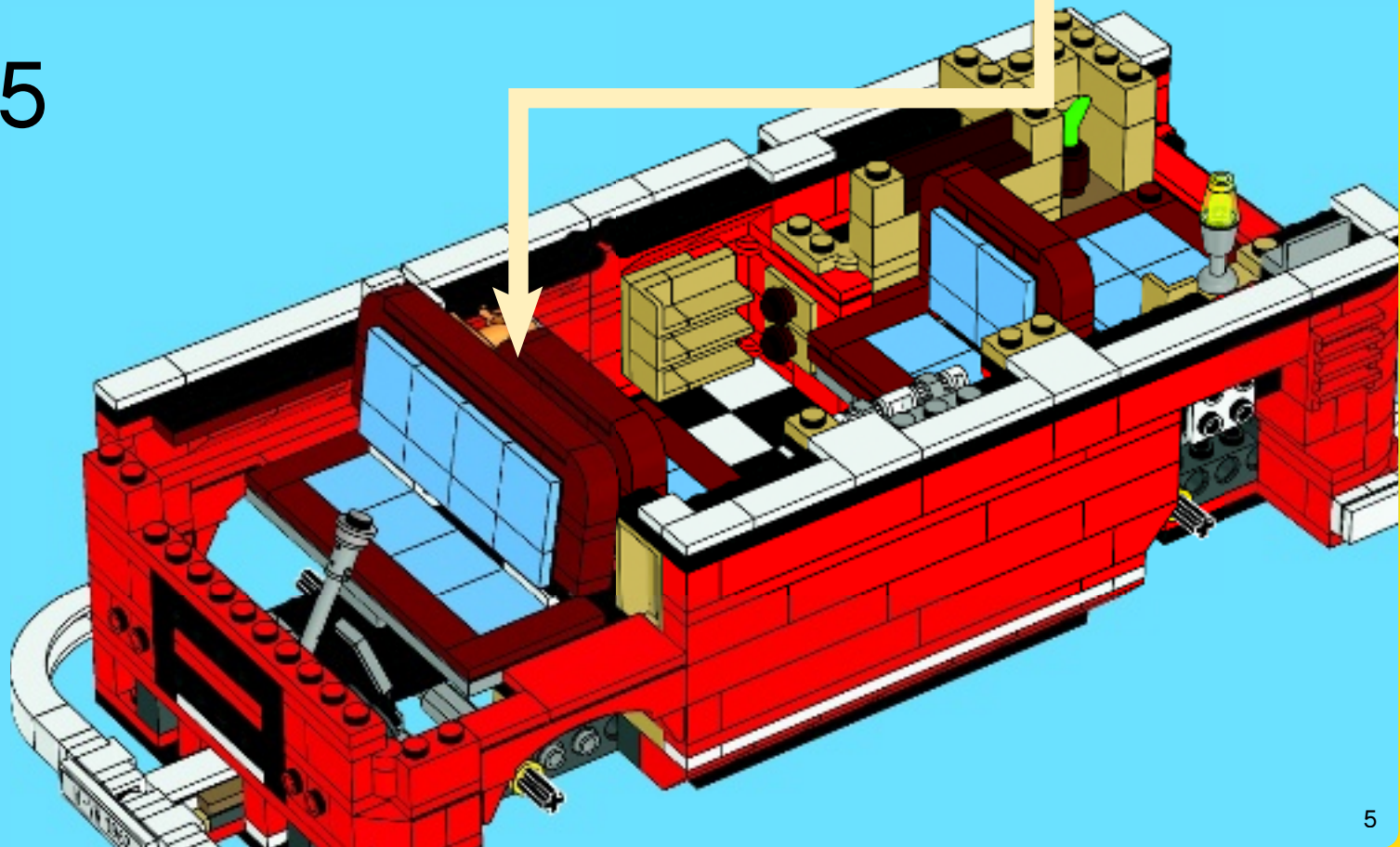

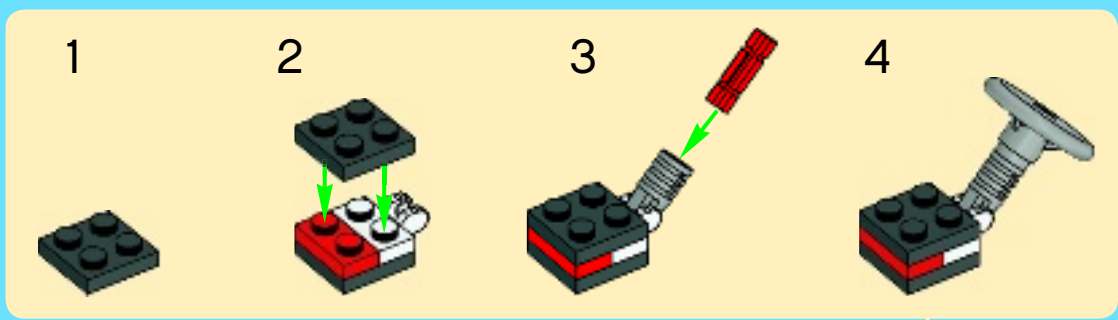
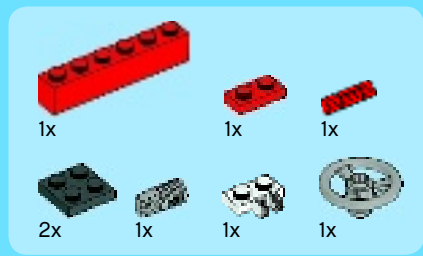

76

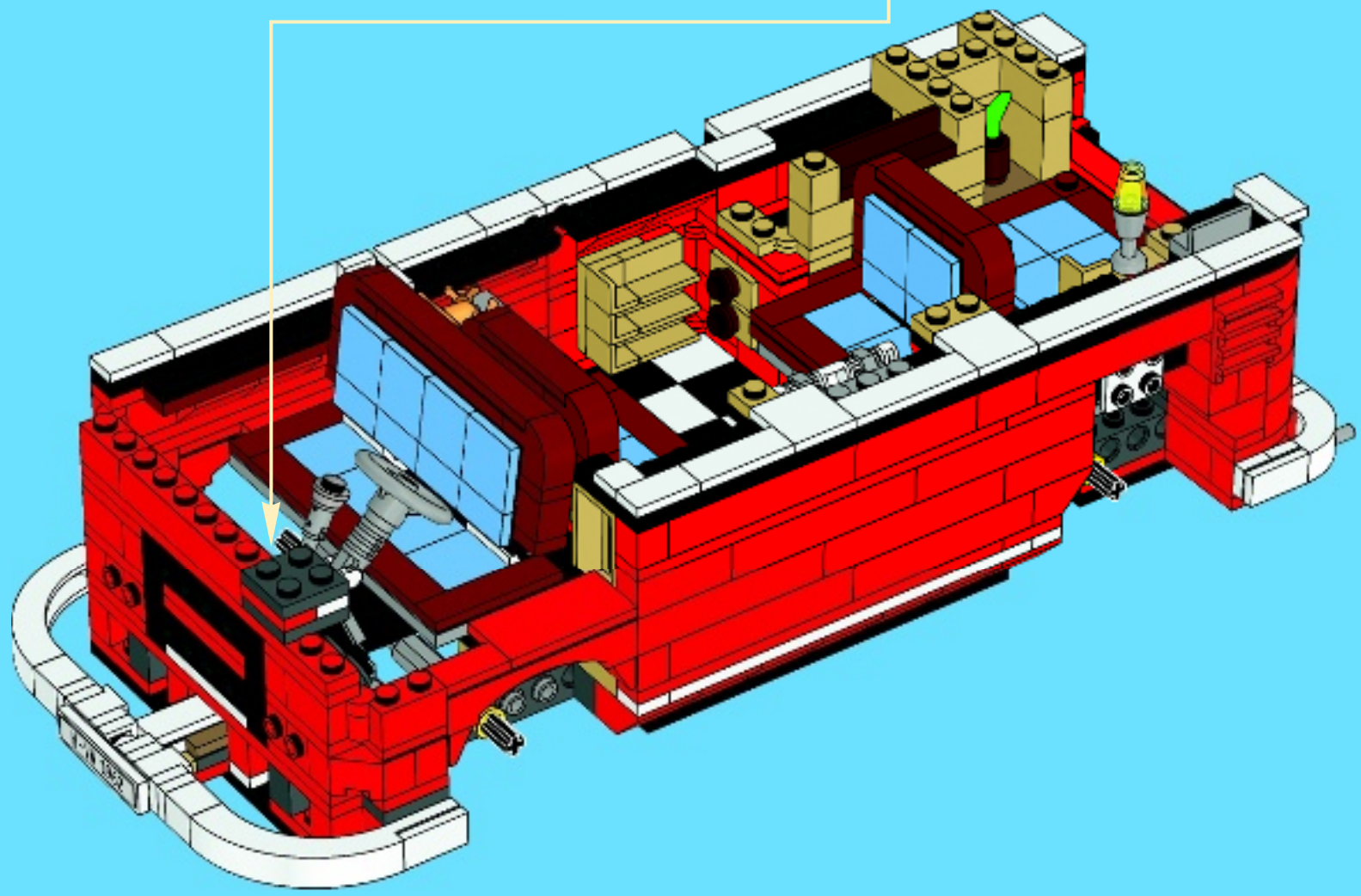

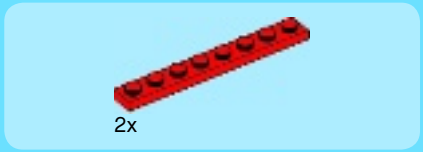

1

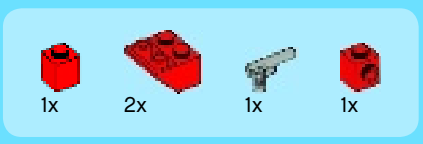
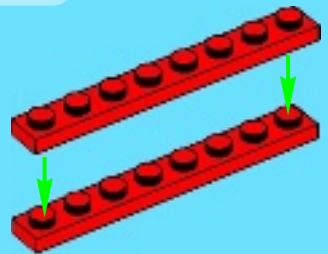

2

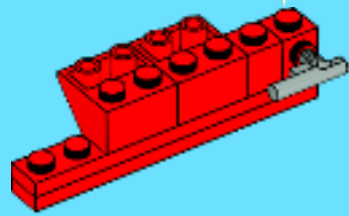
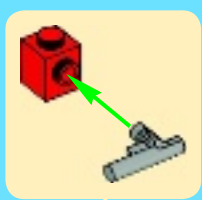

3

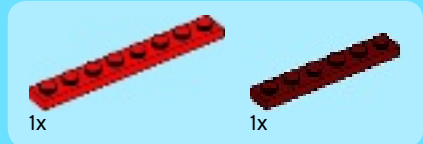
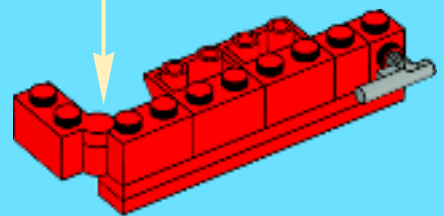
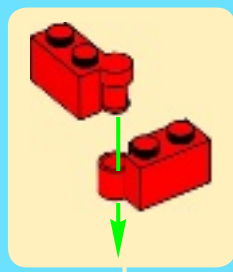

4

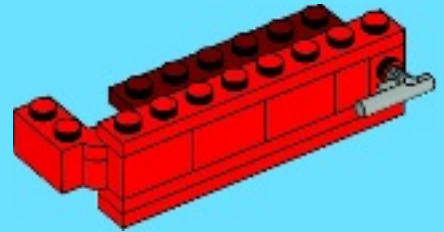

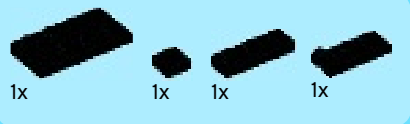

5

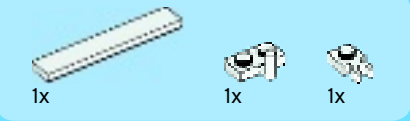
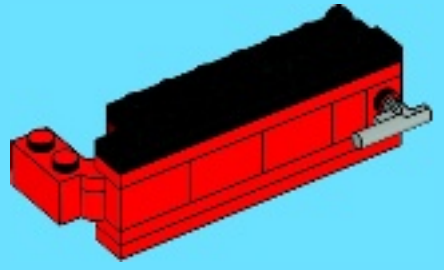

6

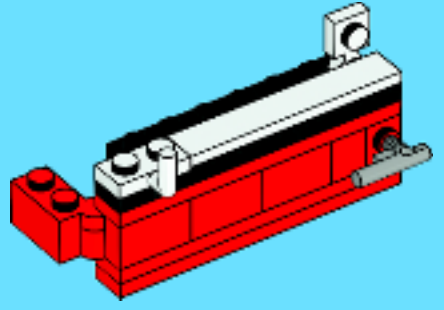

77

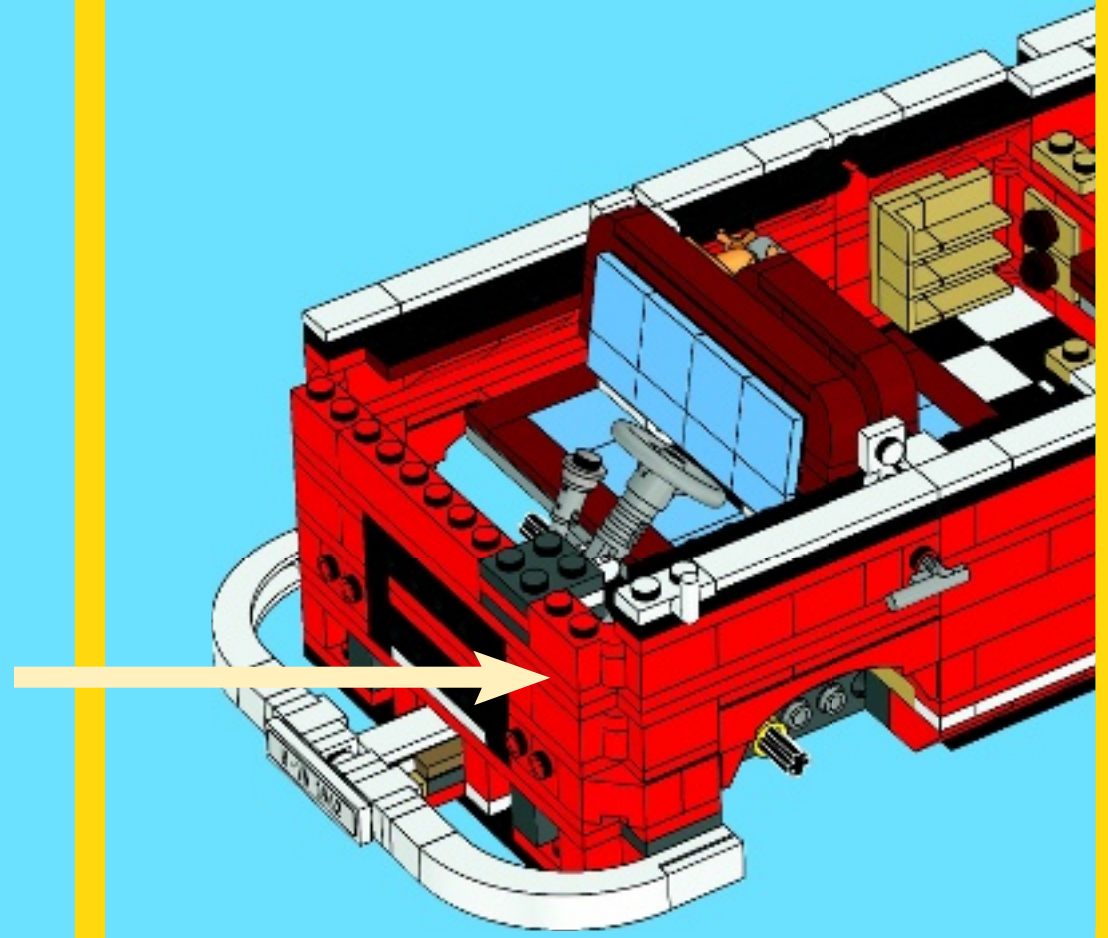



2x



2x



2x

78

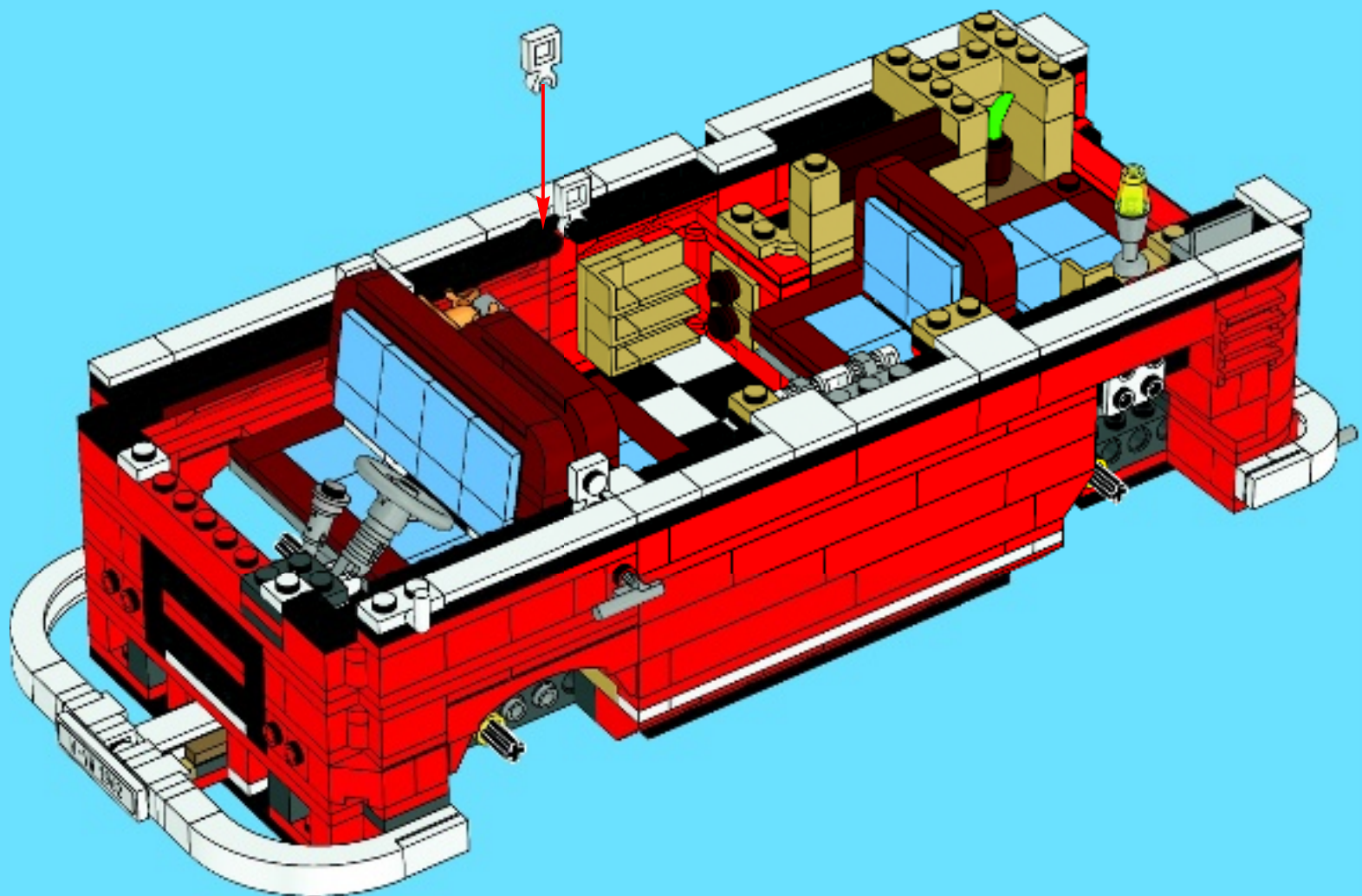



3x



2x

79

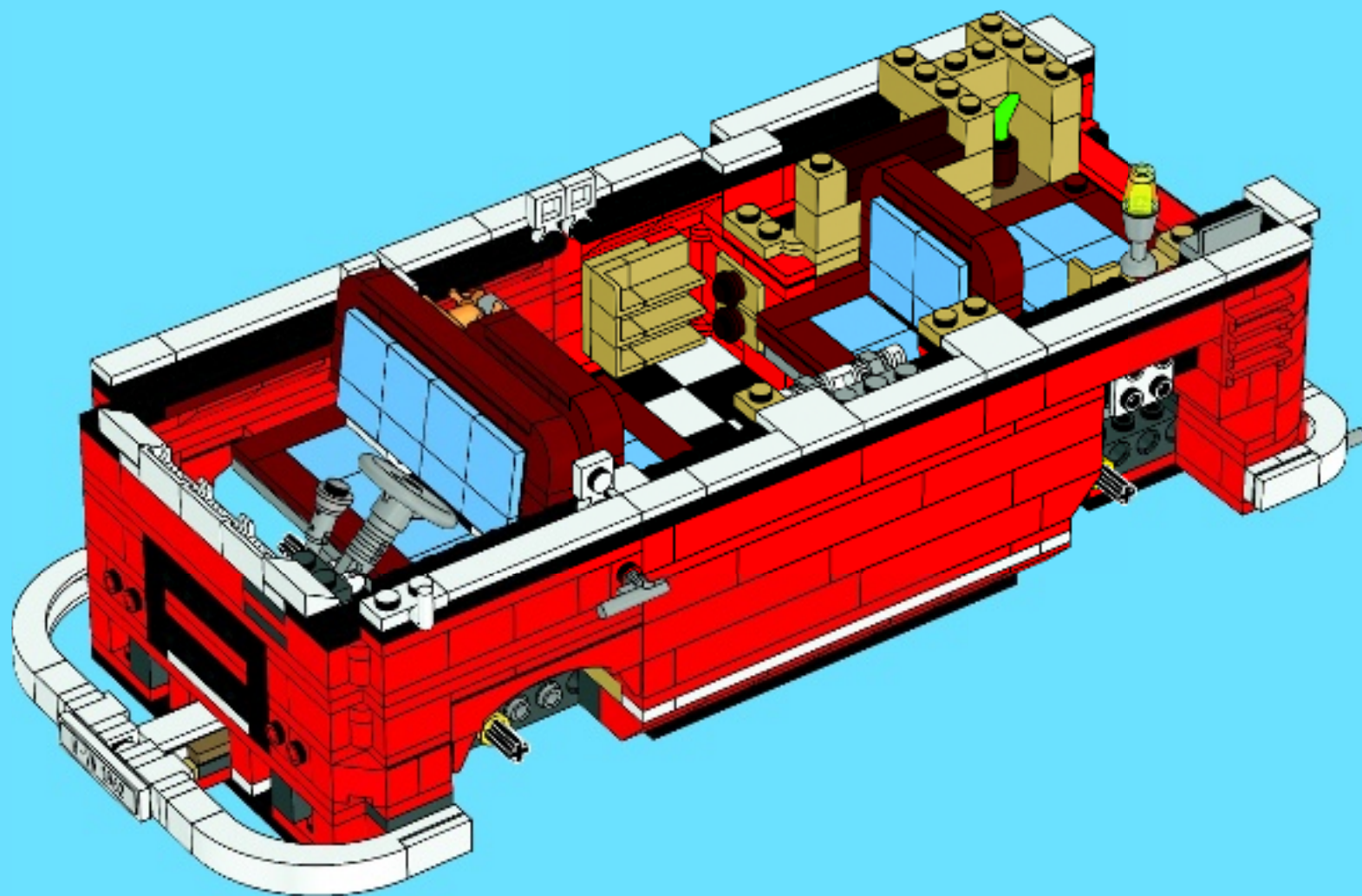

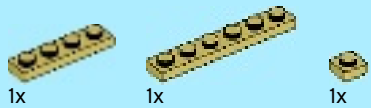

80

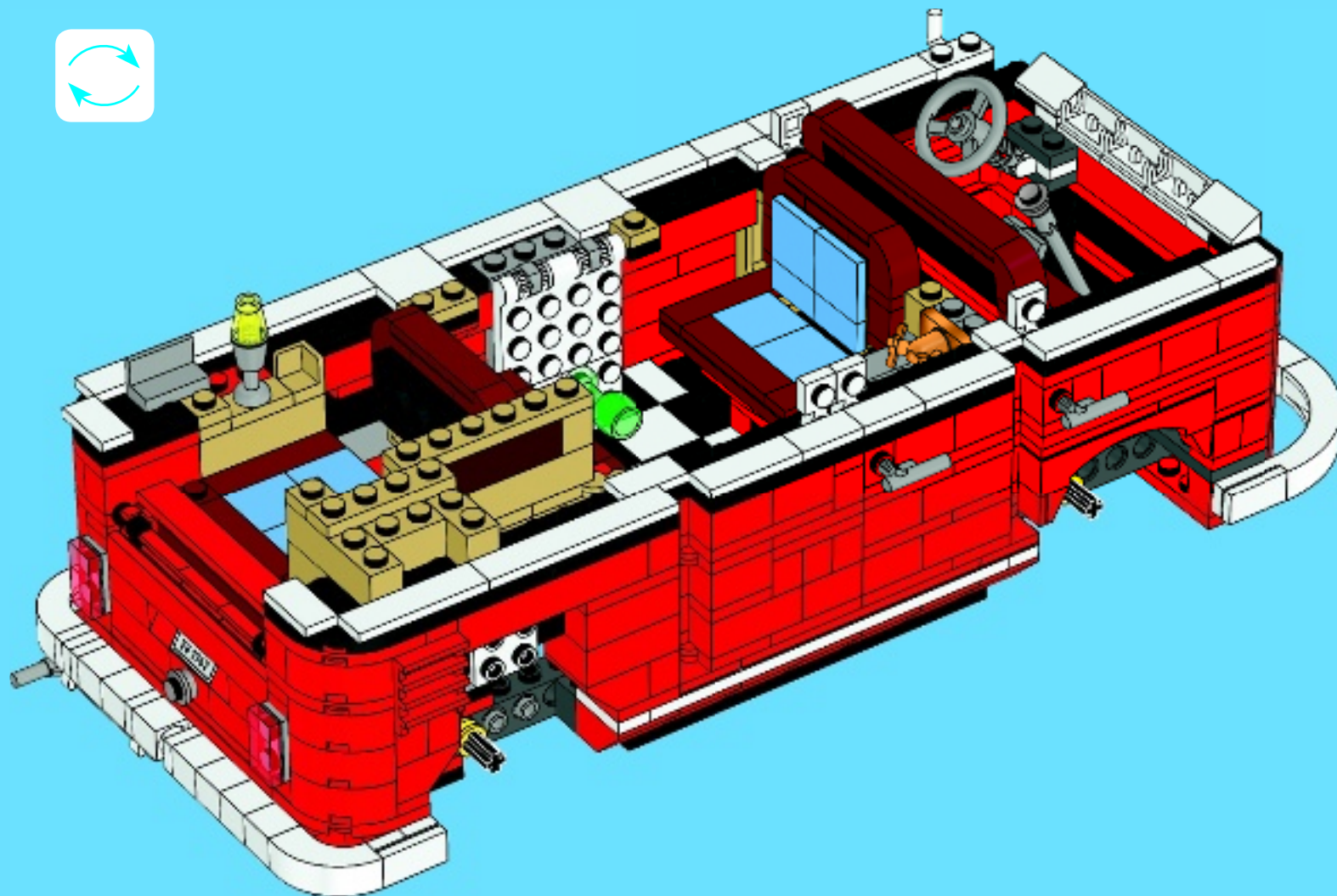



3x



1x



1x



1x

81

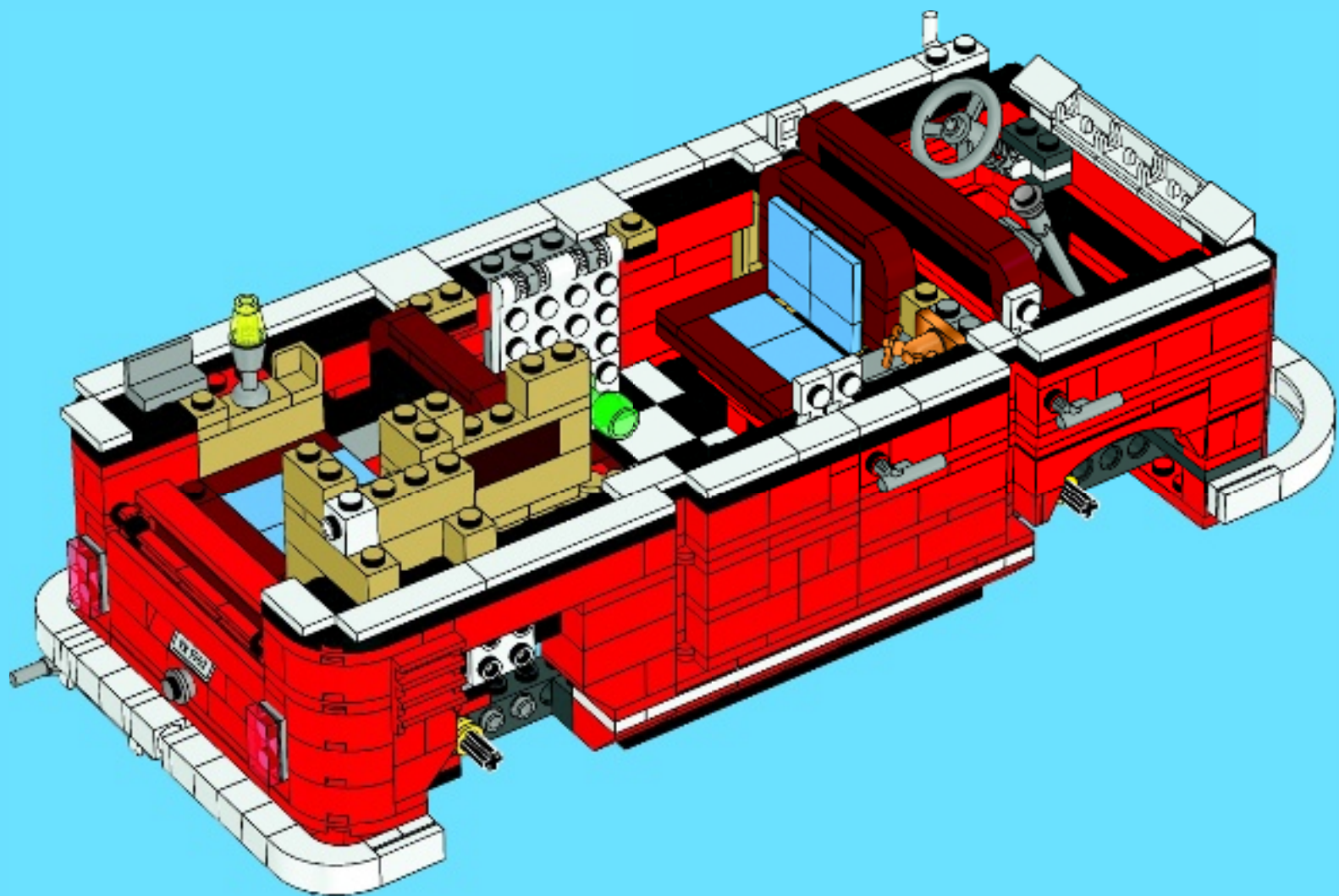

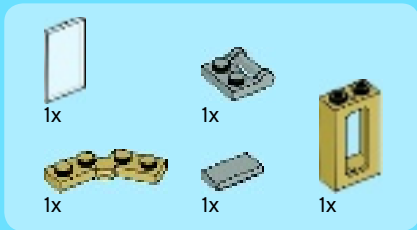

82

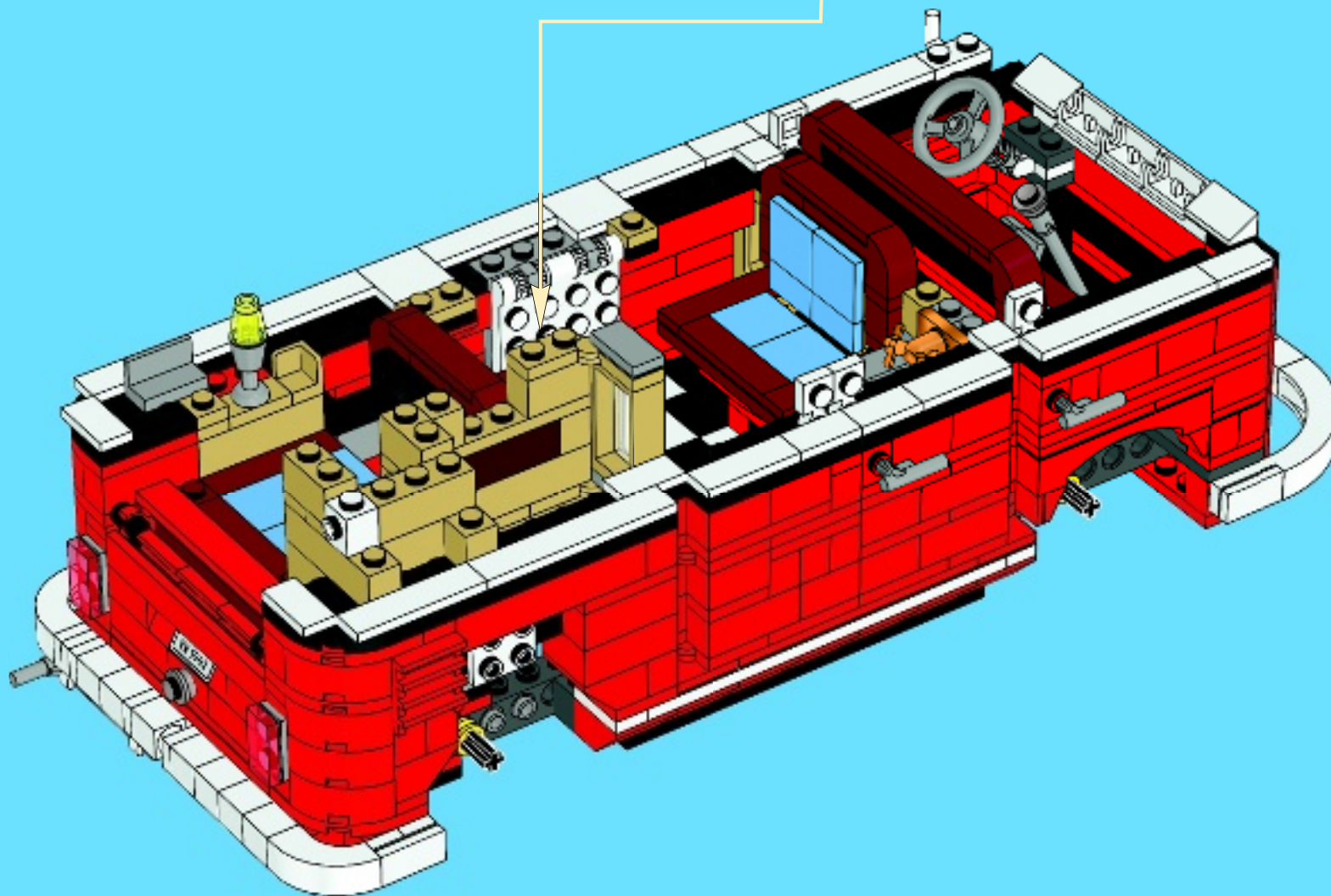
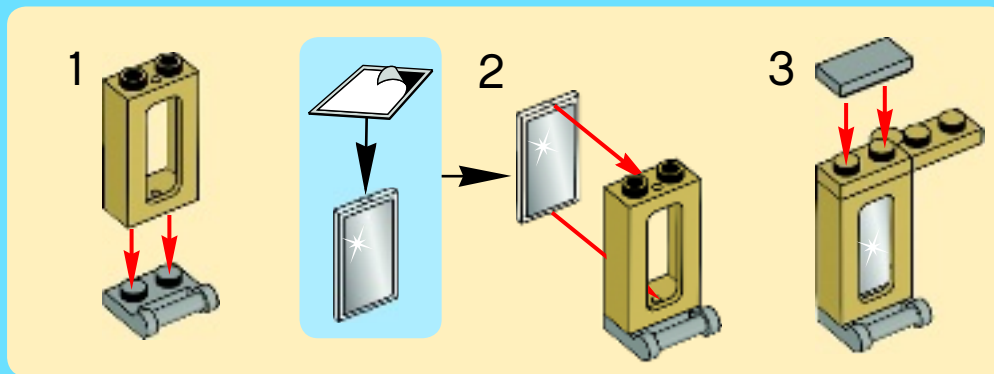

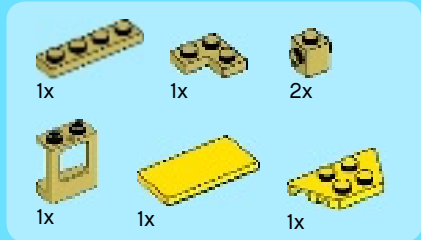

83

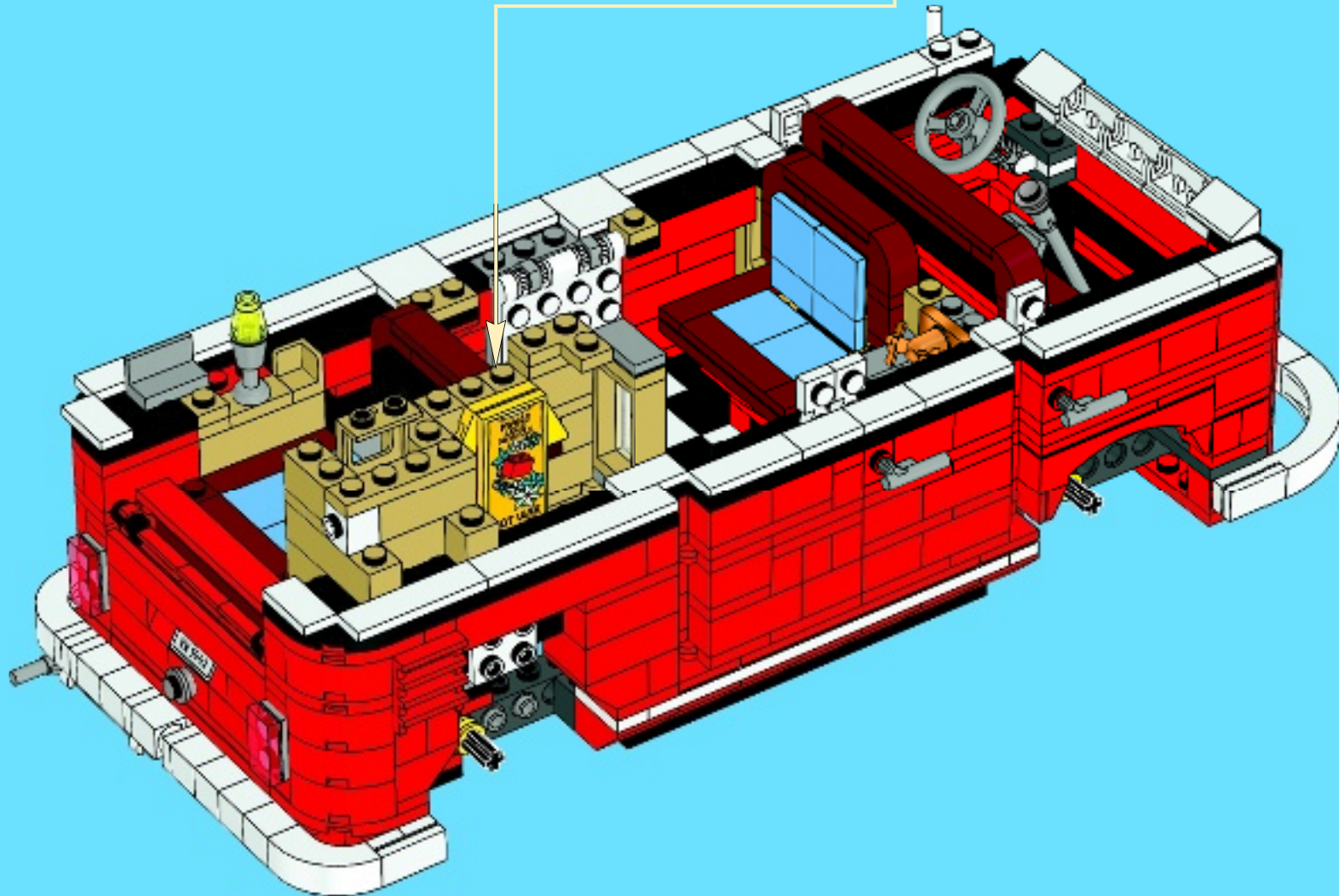
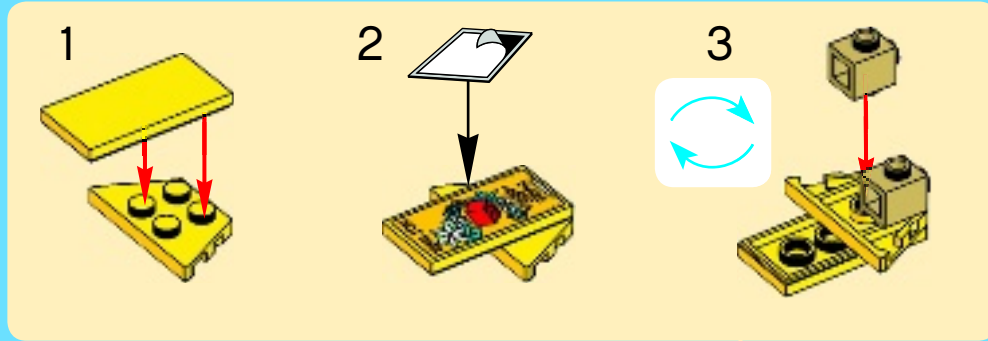

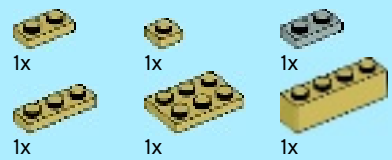

84

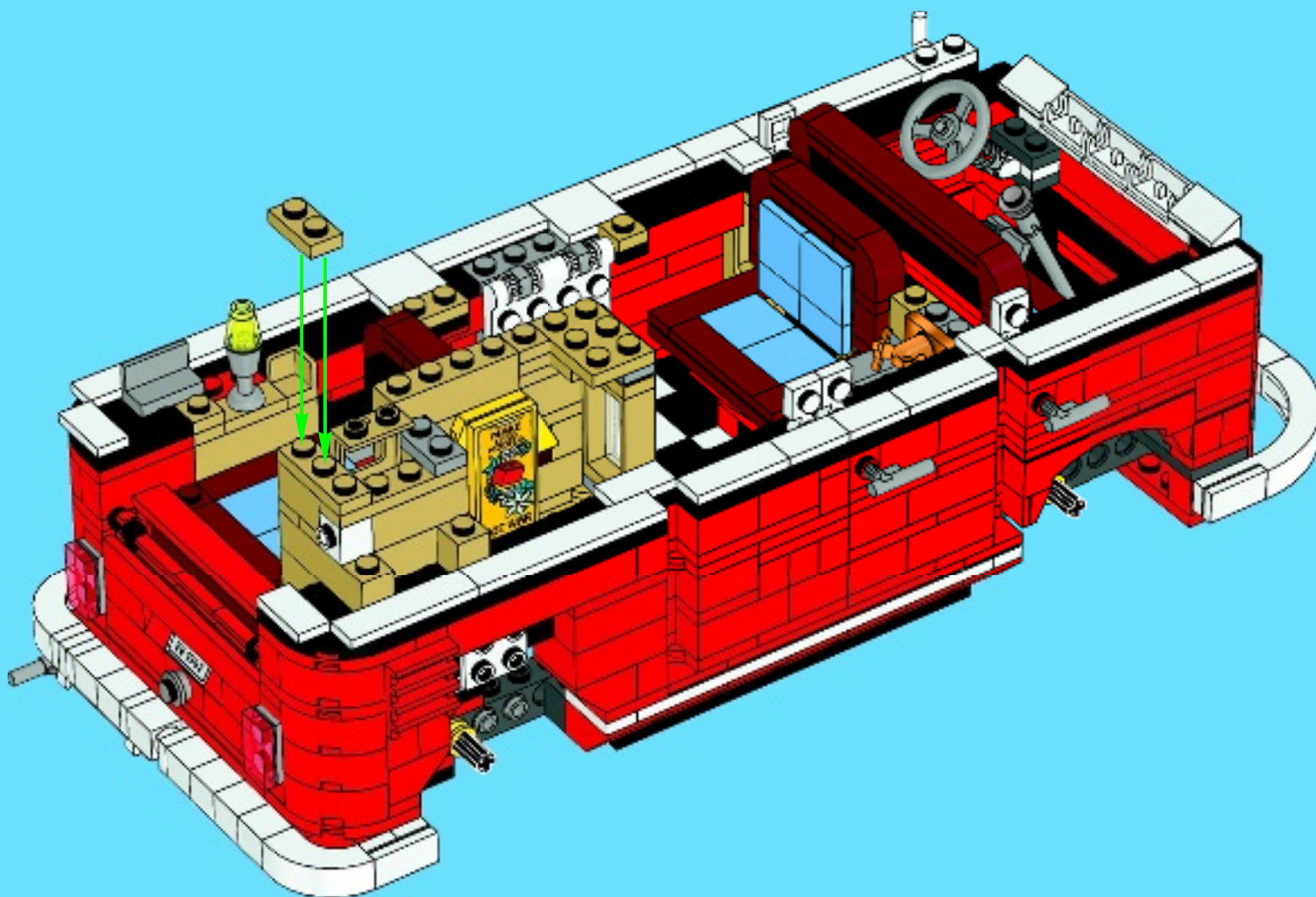



1x



1x



1x



1x

85

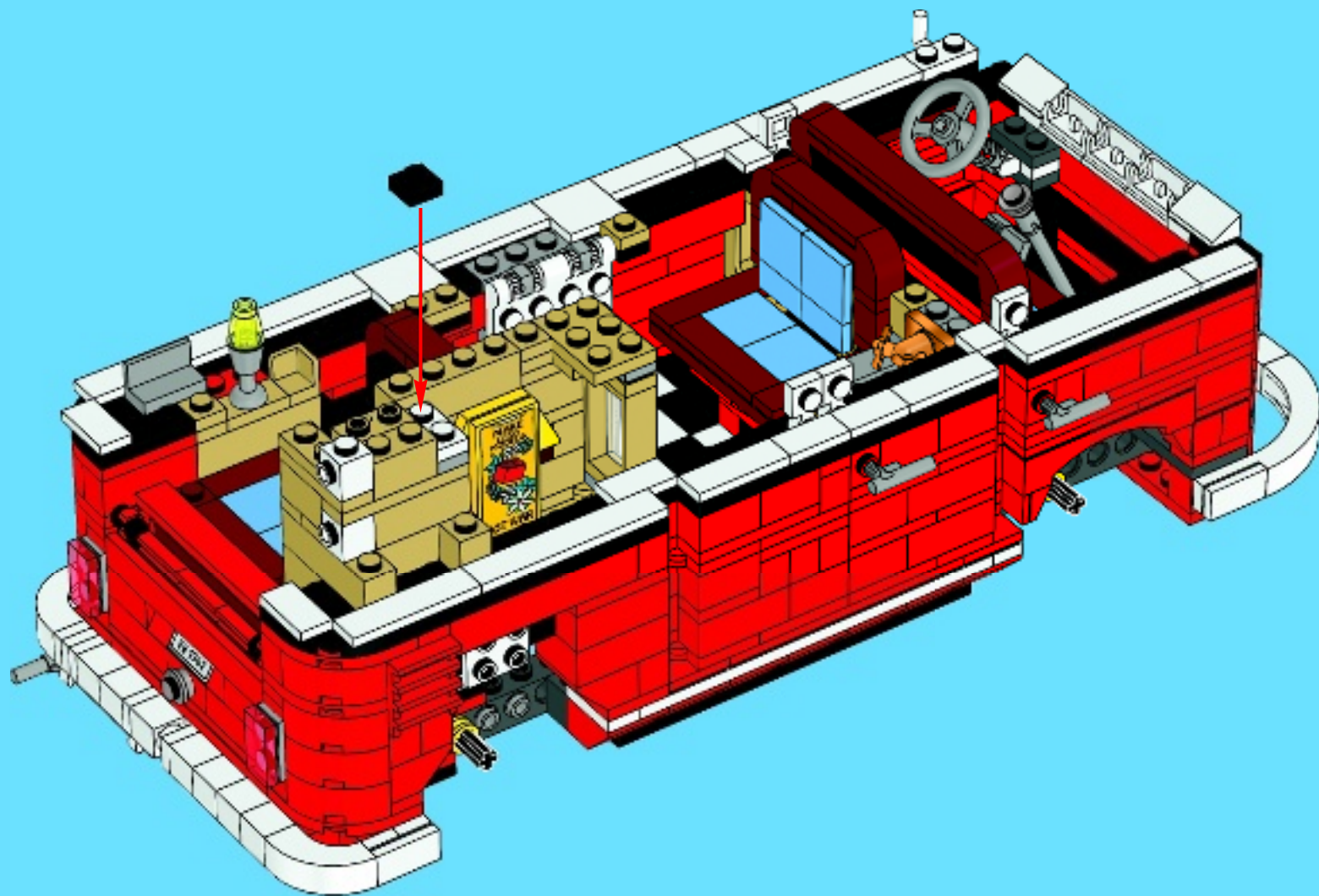



1x

1

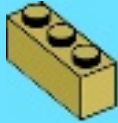

1x



1x

2

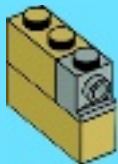

1x



1x



2x

3

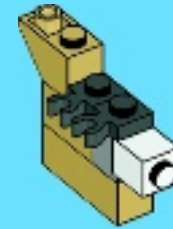

1x



1x

4

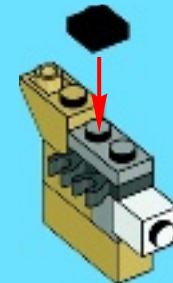



5

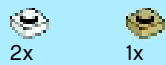

6

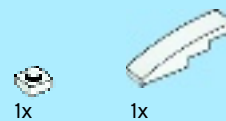
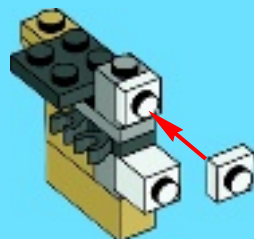

7

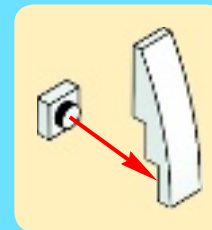
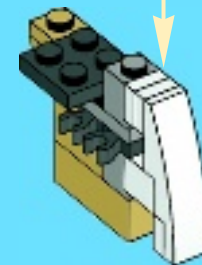

8



86

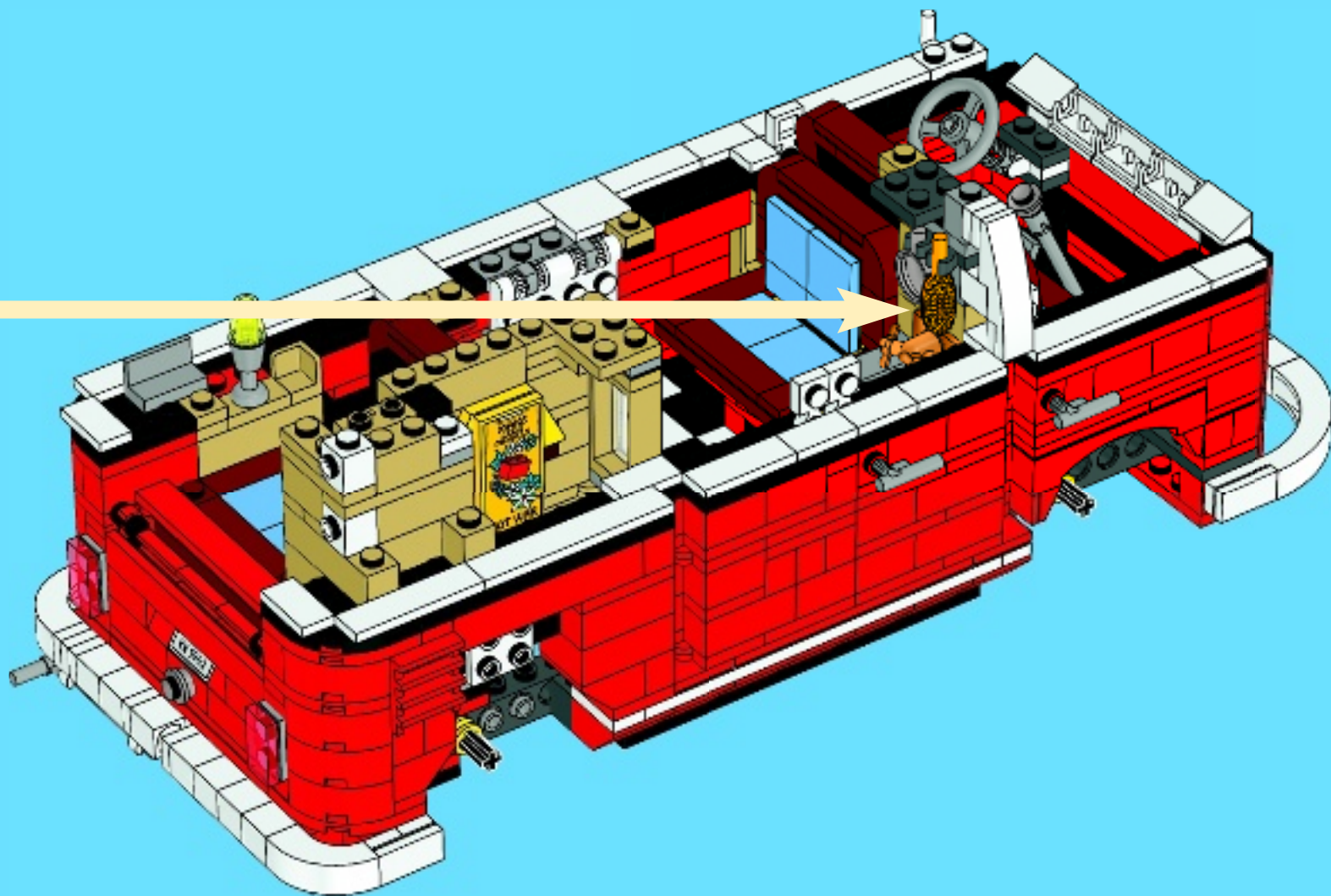

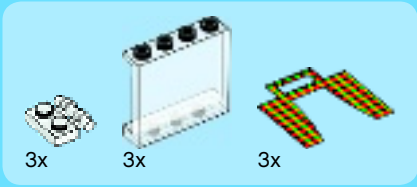

87

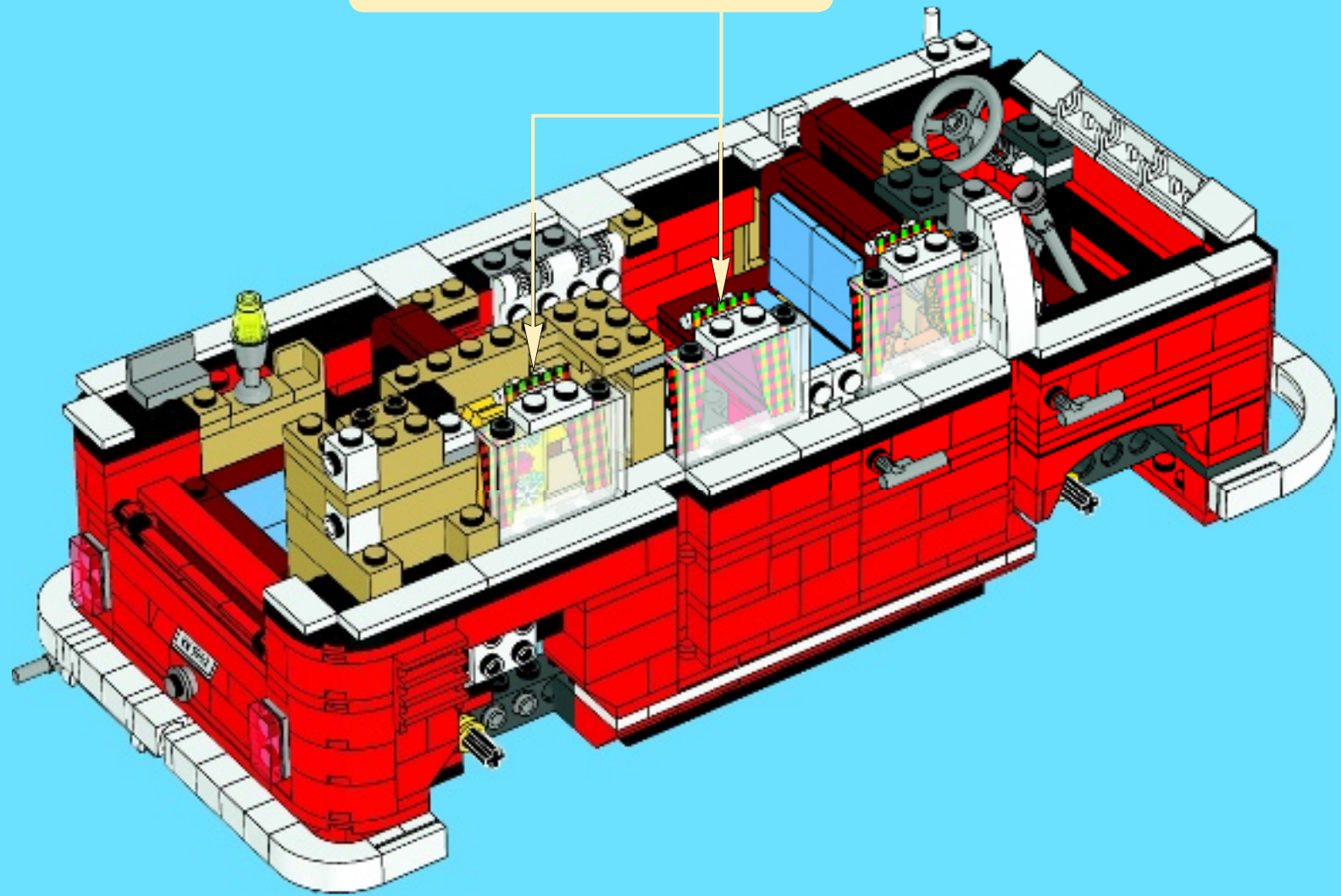
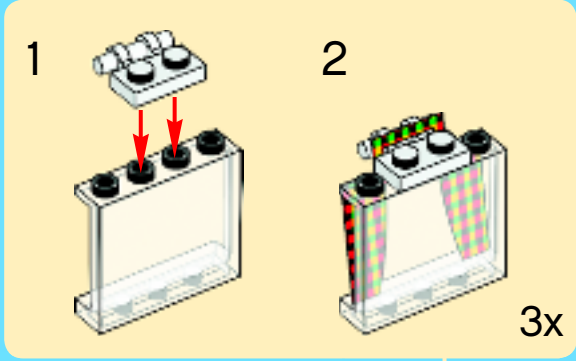



1x



3x



2x

88

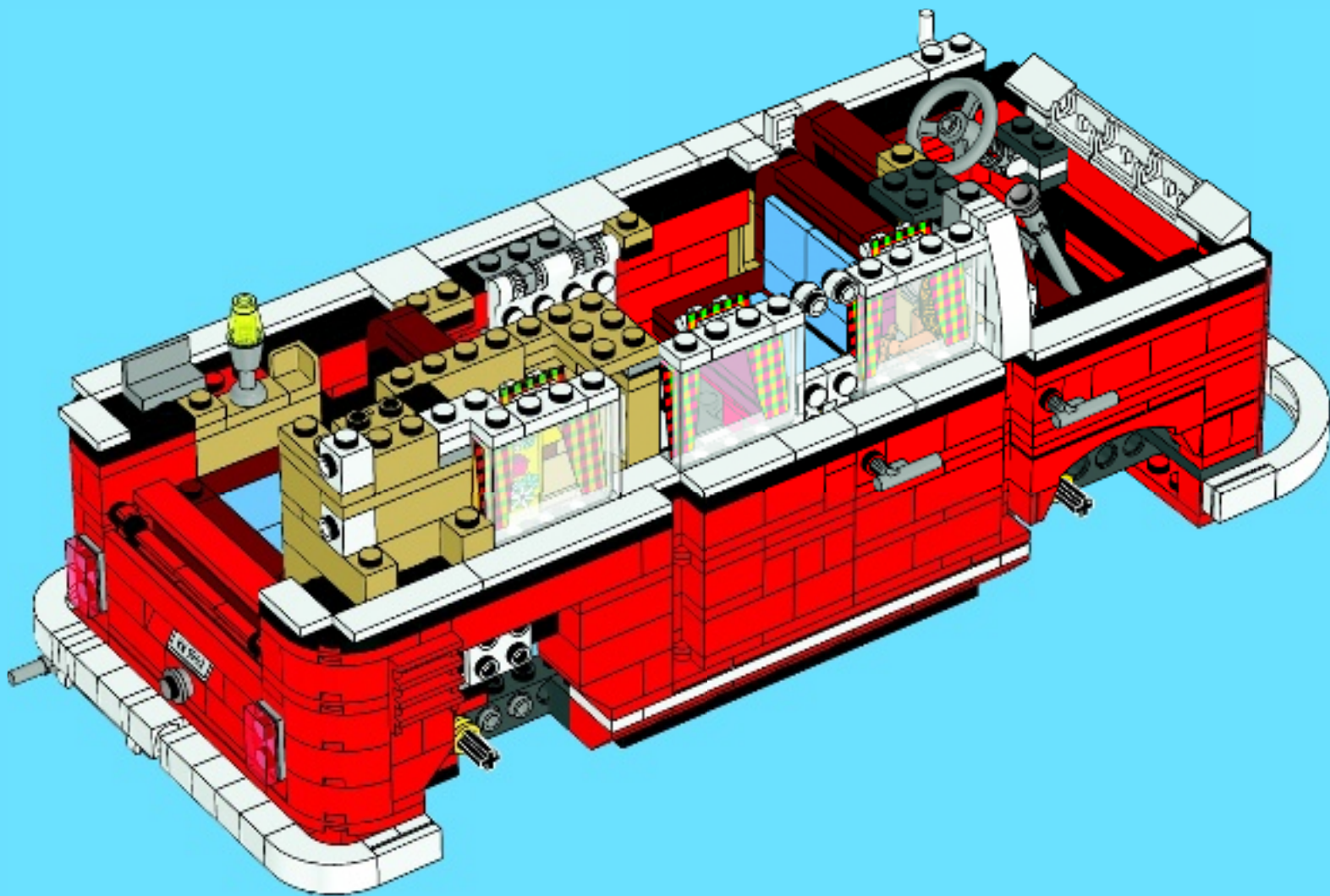

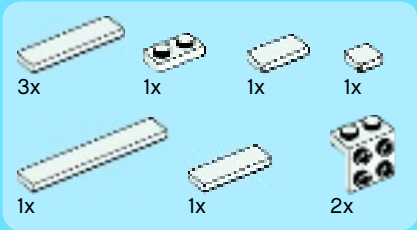

89

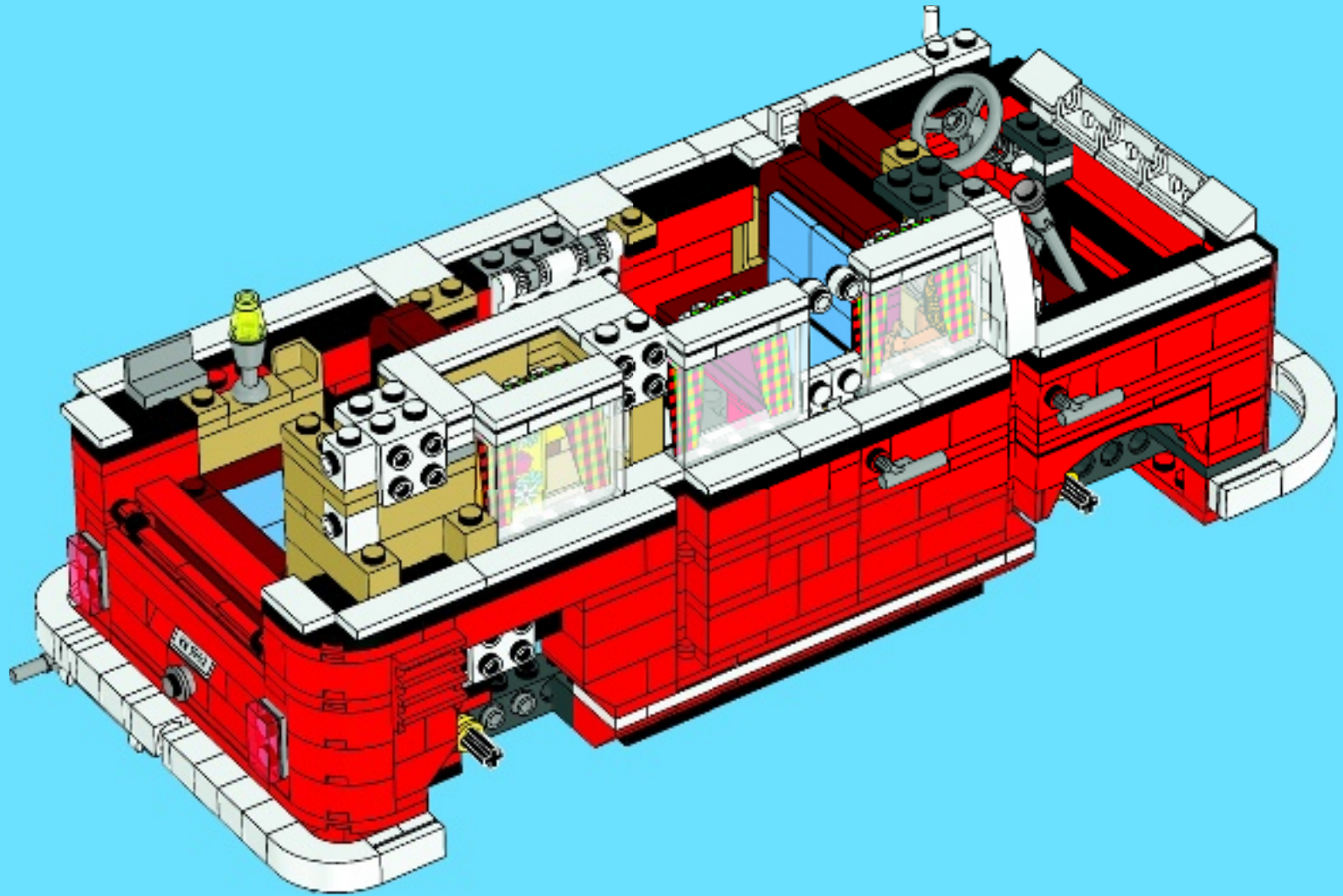

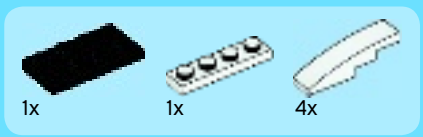

90

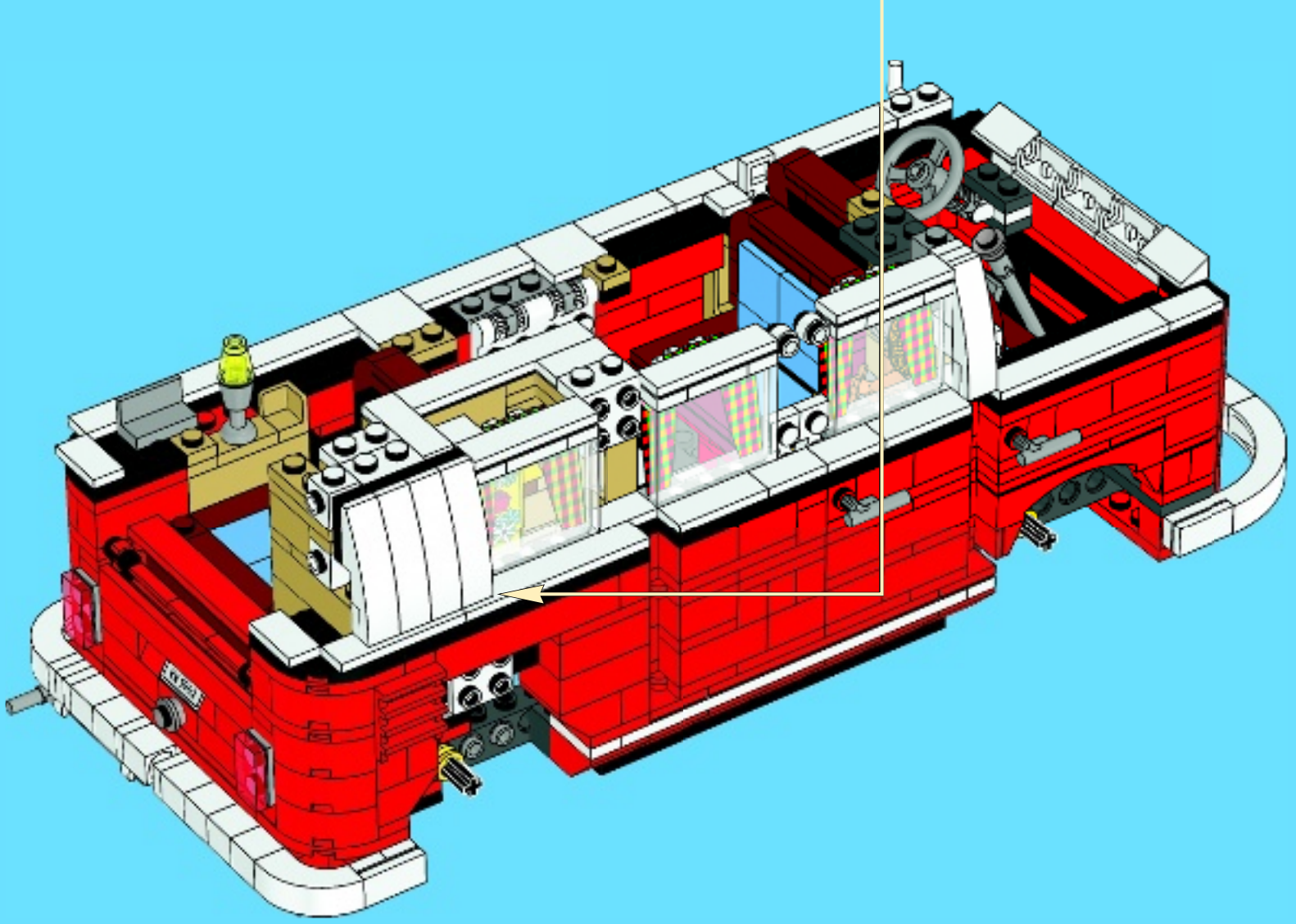

91

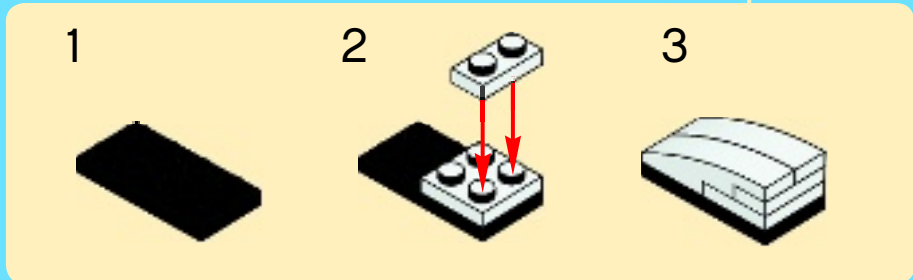
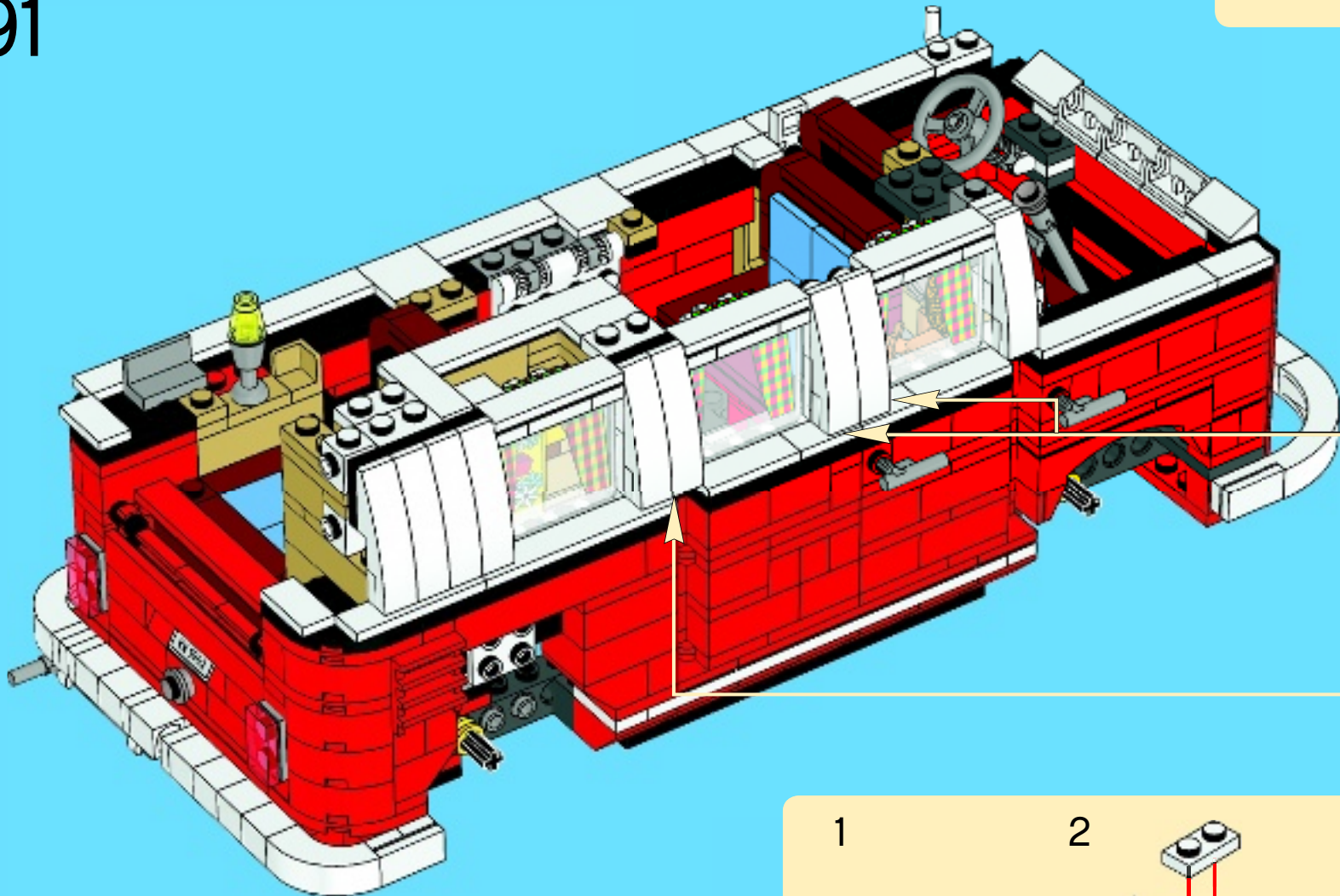
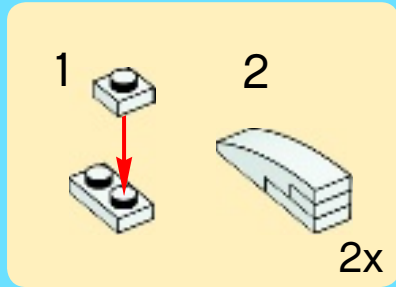
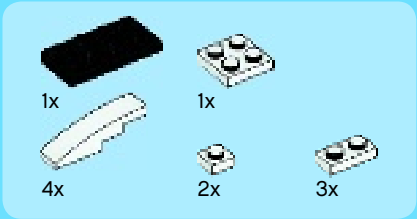

- 1x
- 1x
- 1x
- 1x
- 2x
- 1x
- 1x
- 1x

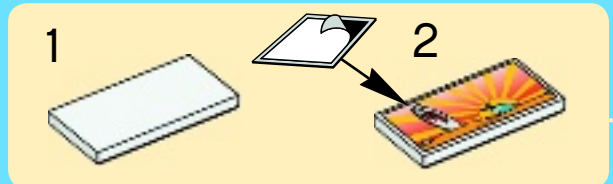

92

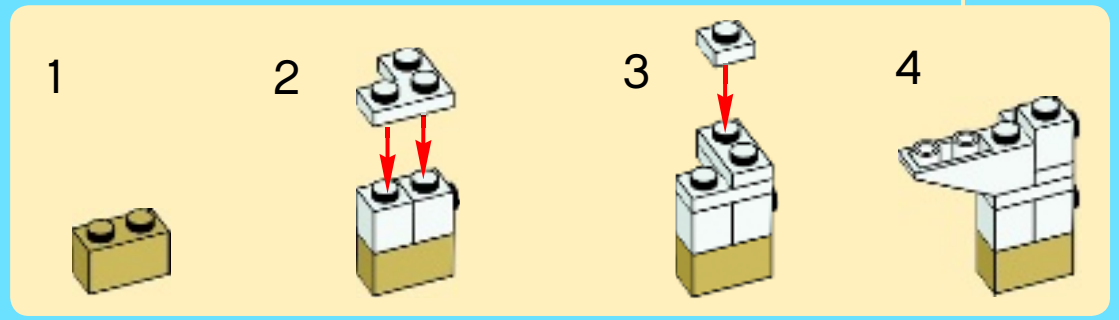
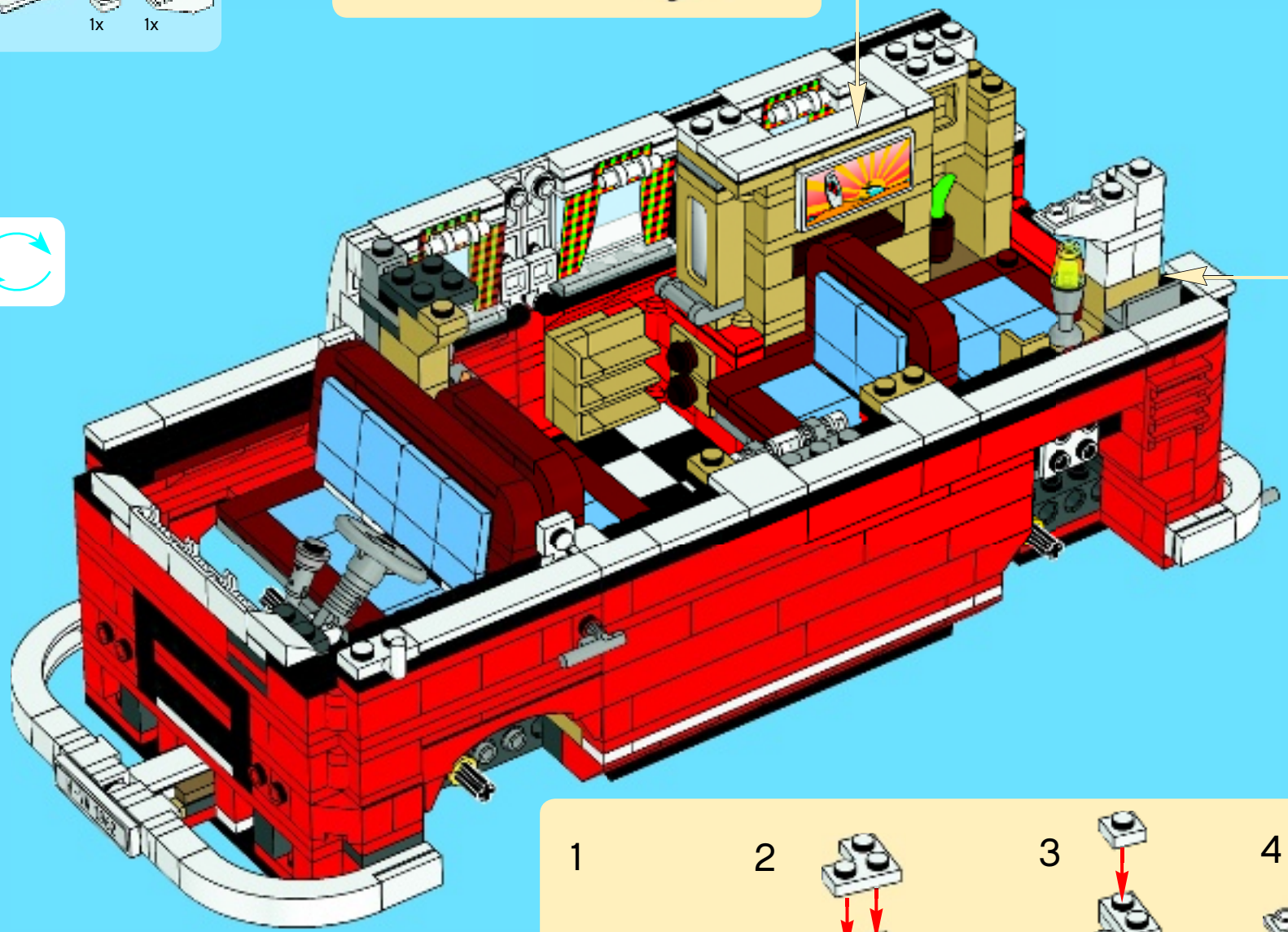

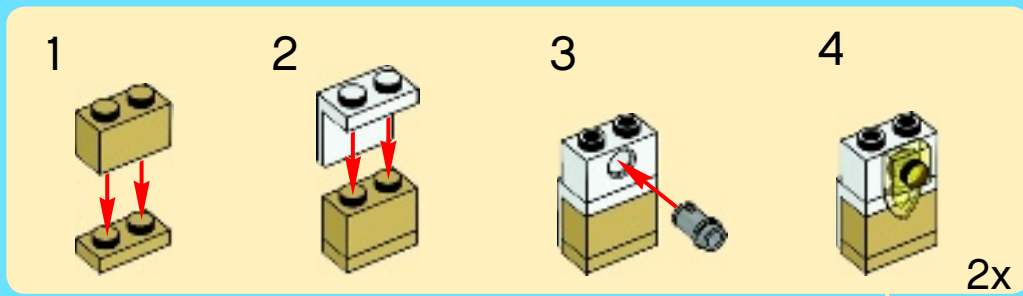
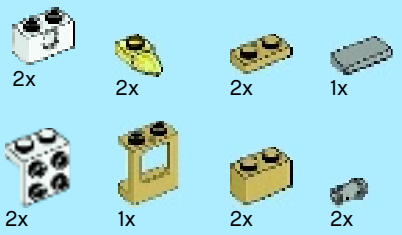

93

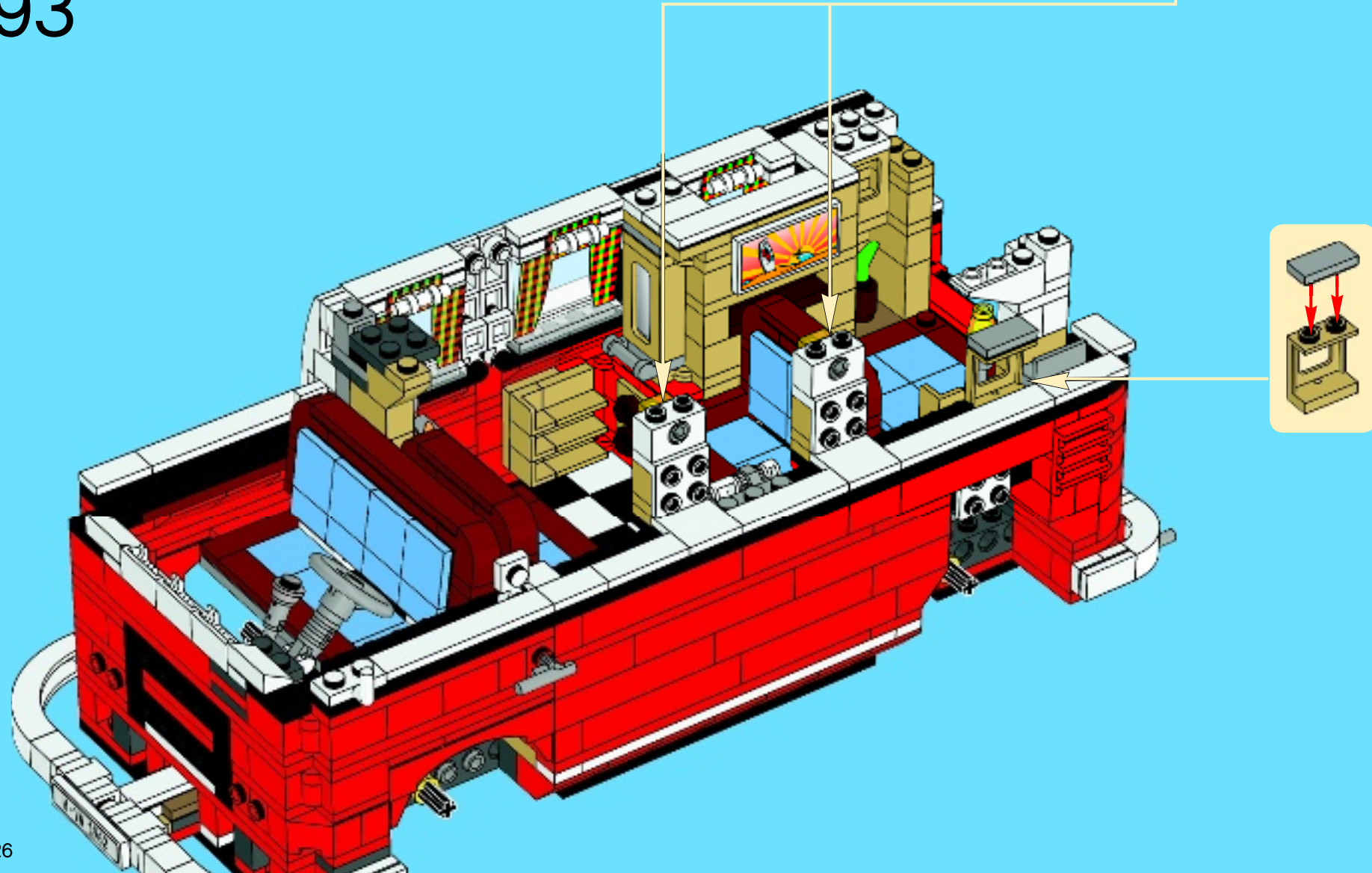

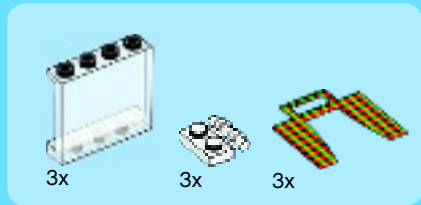

94

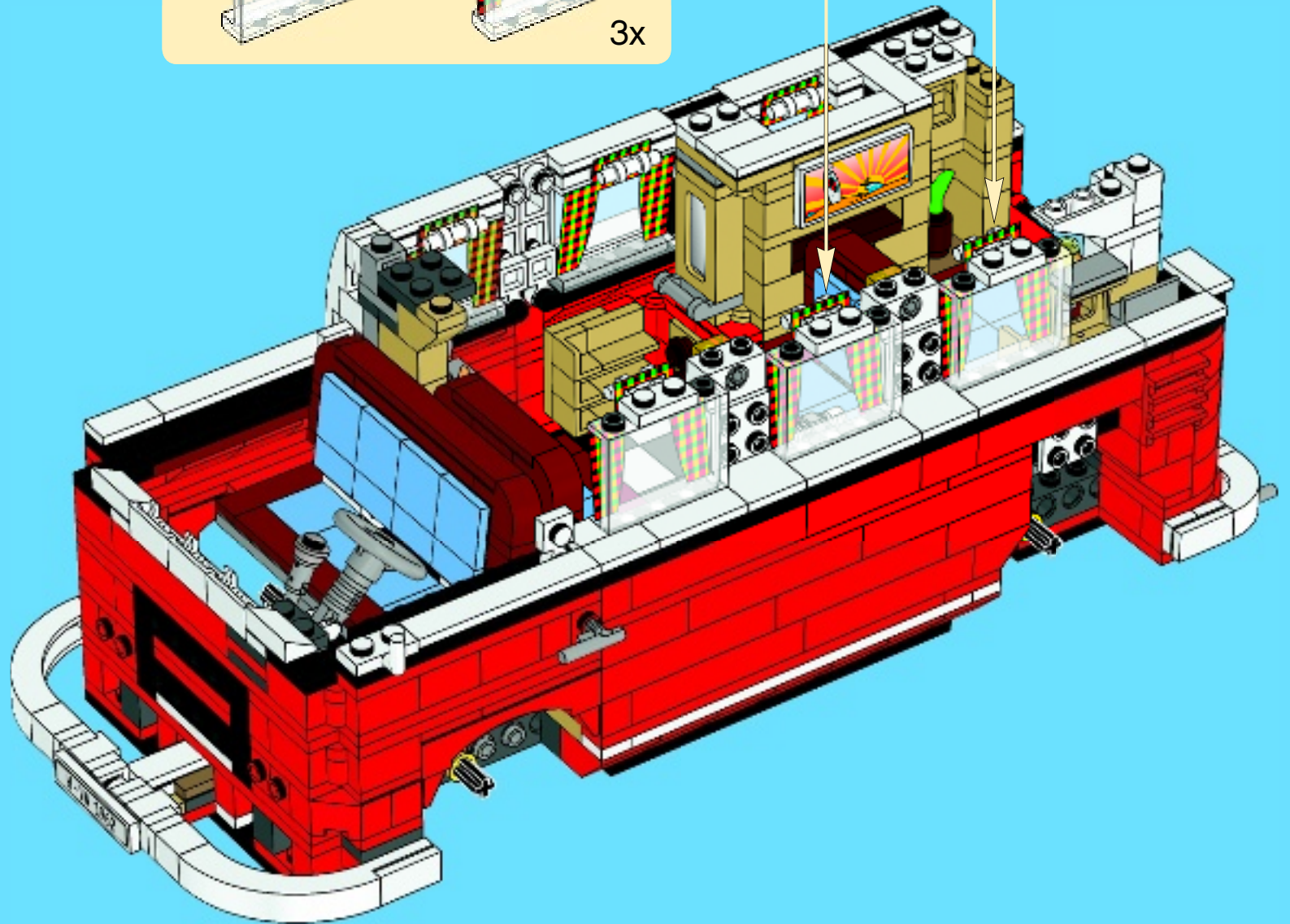
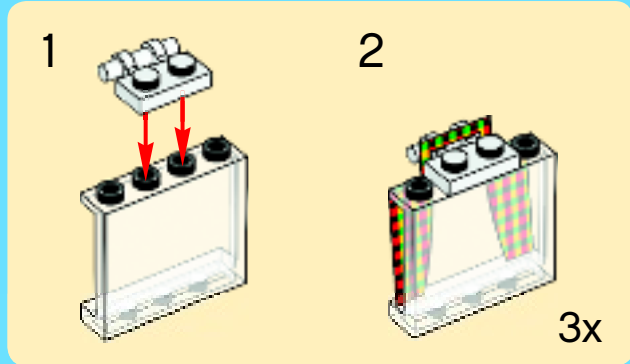



95

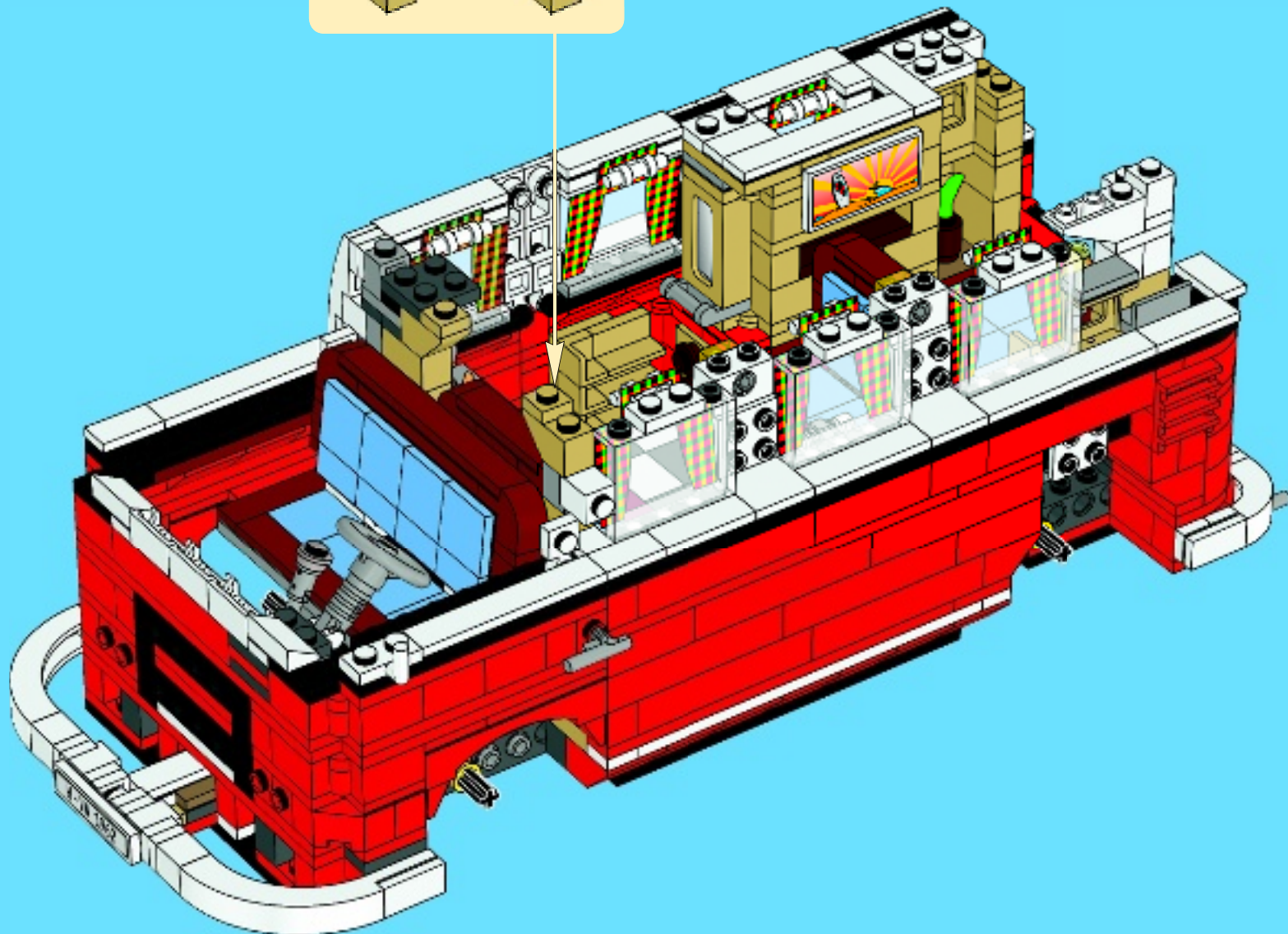
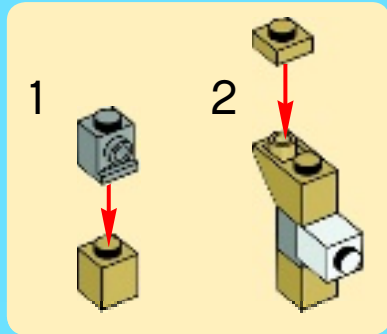



5x



1x

96

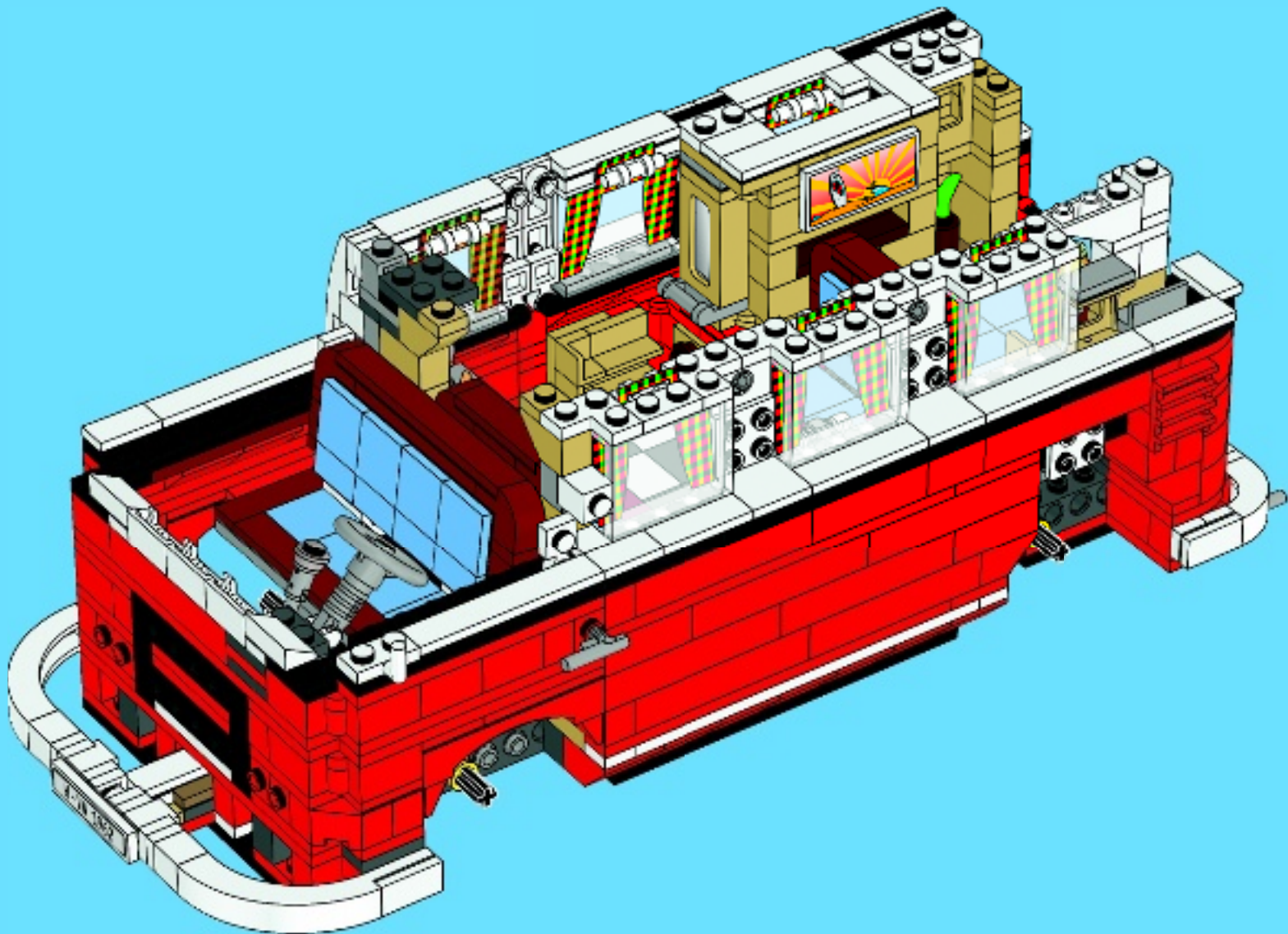



1x



5x



1x



1x

97

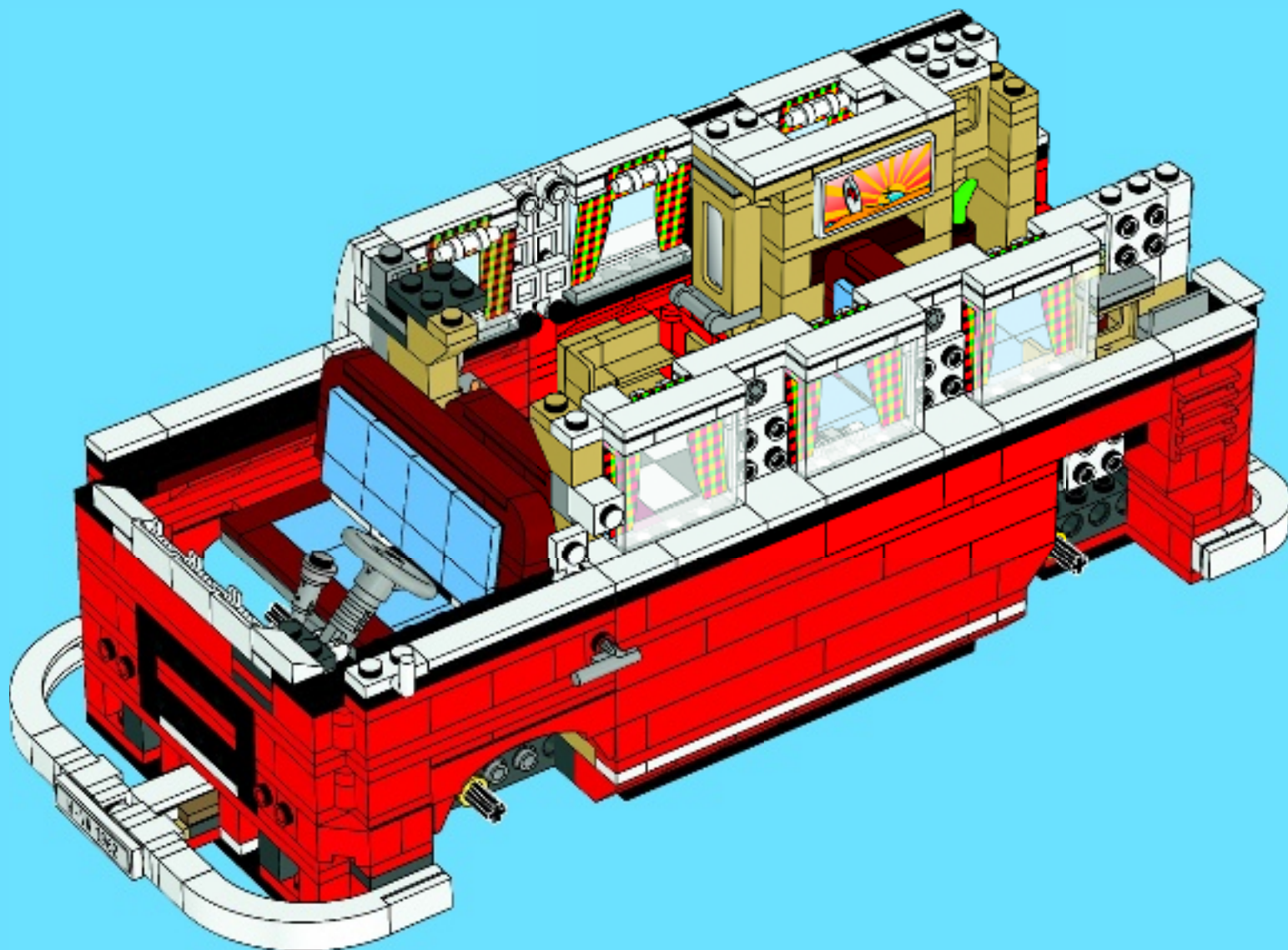

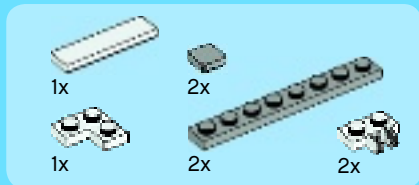

98

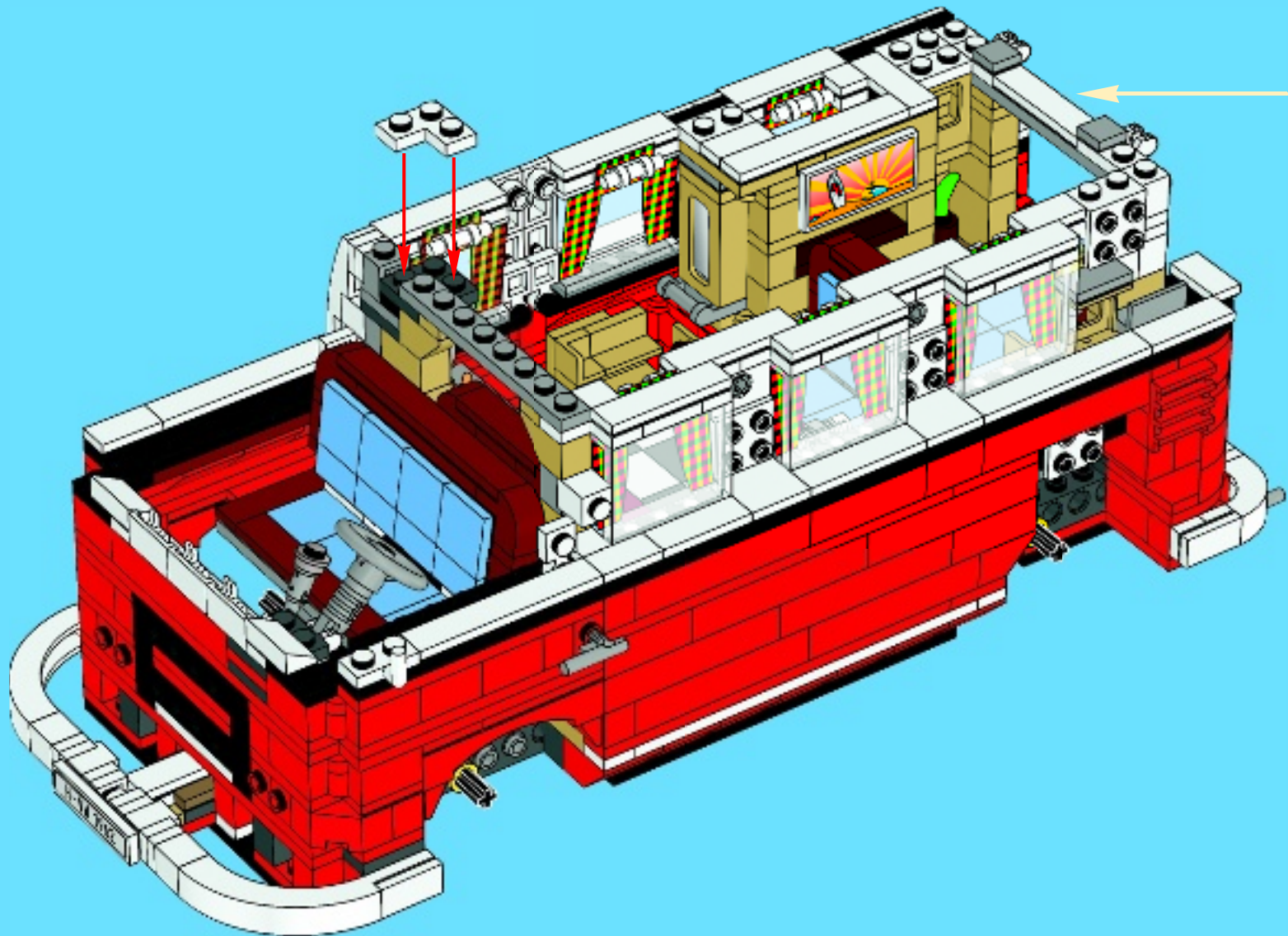
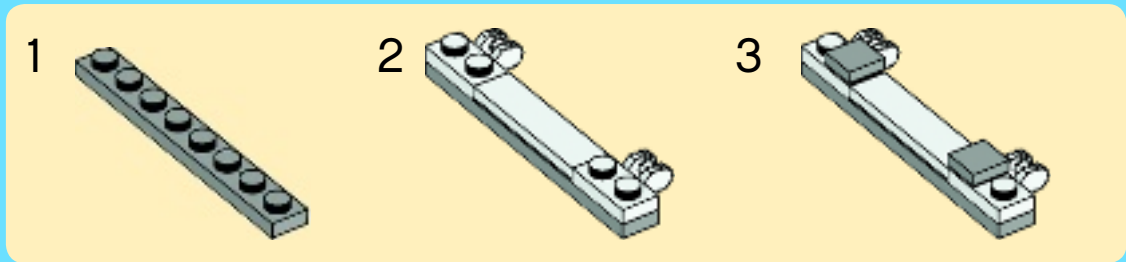

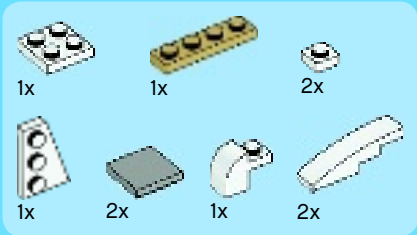

99

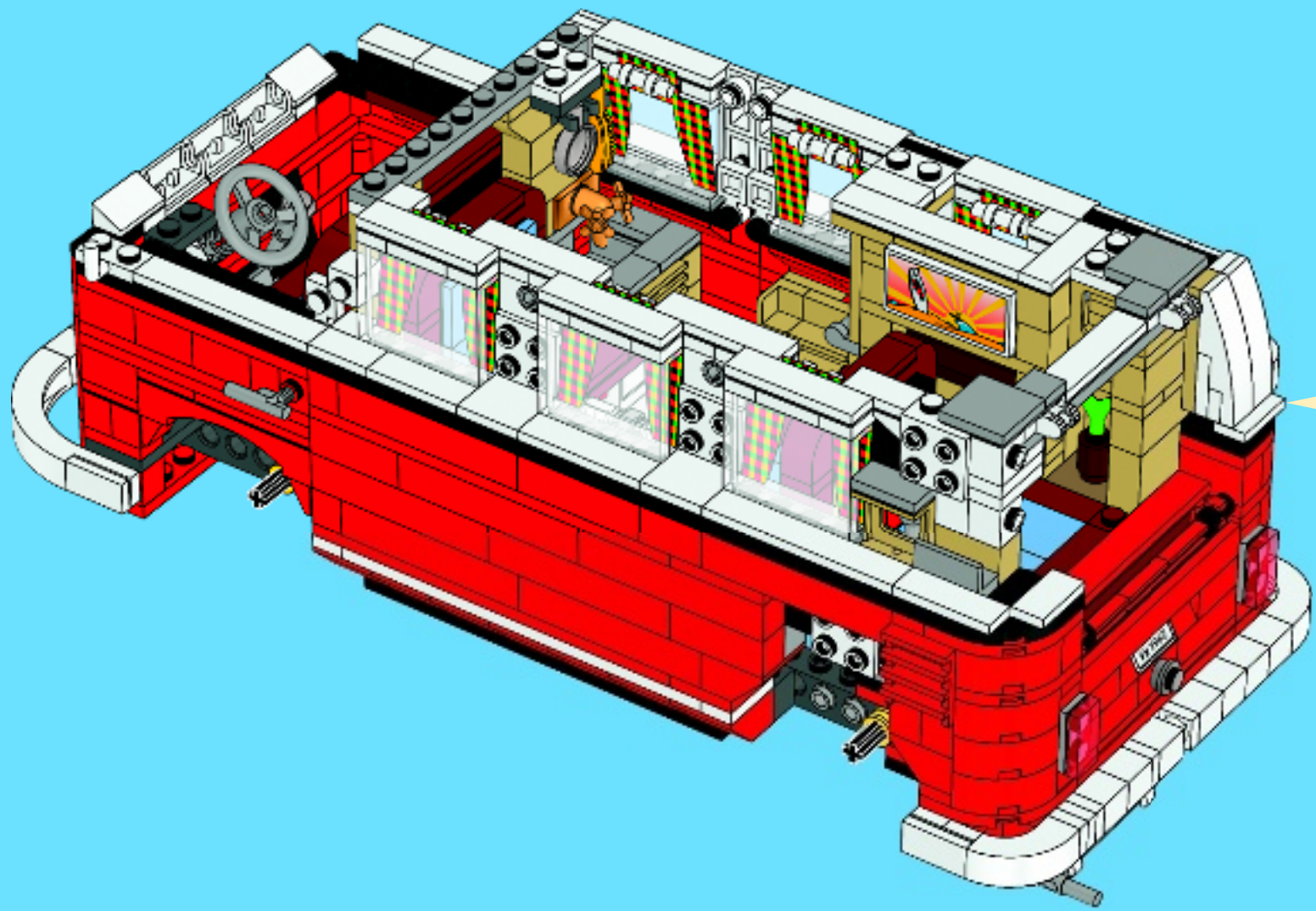

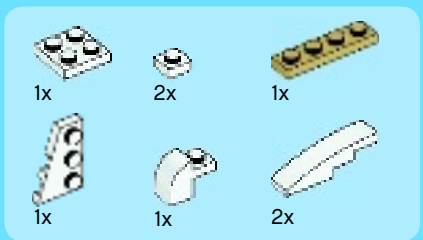

100

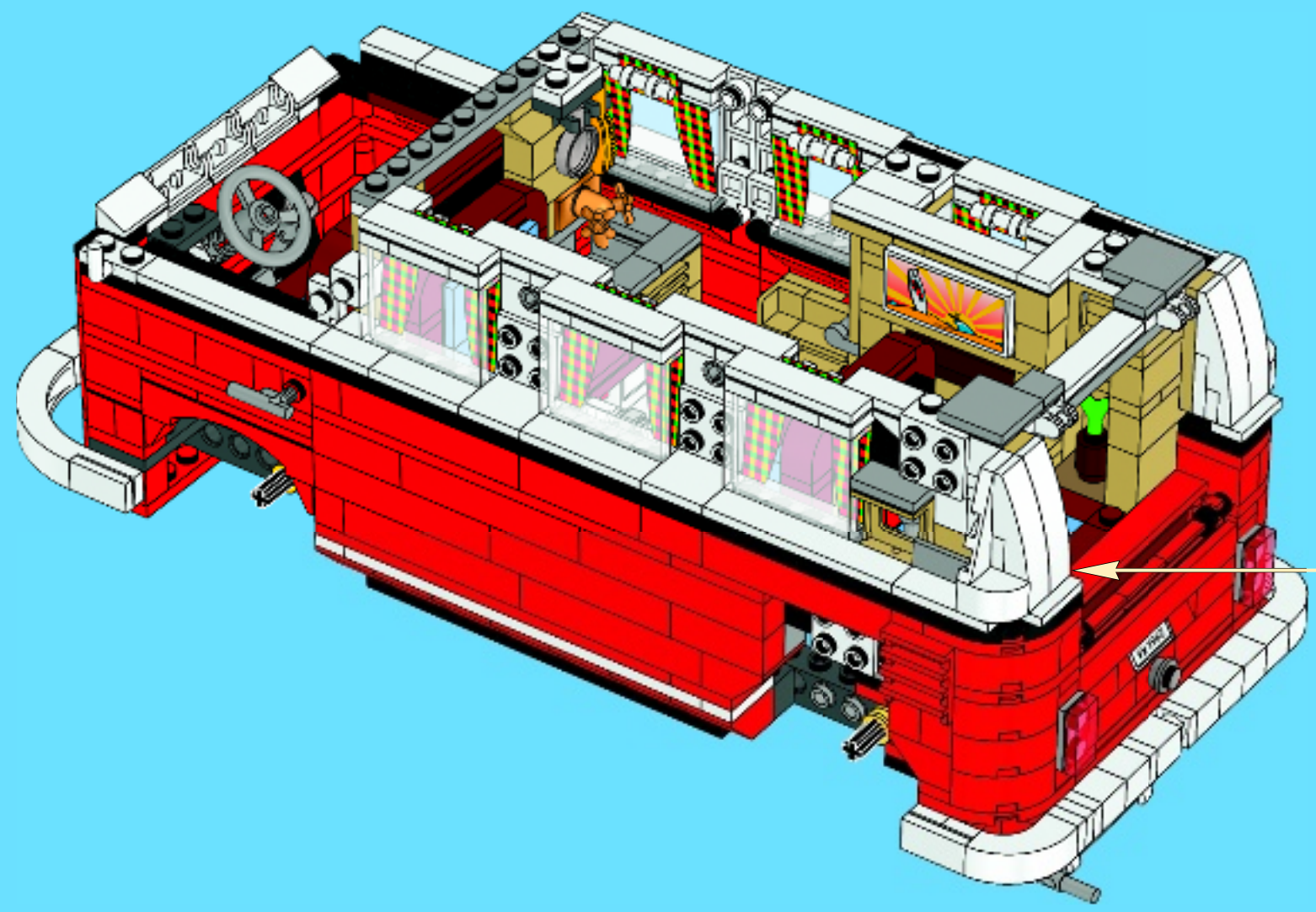

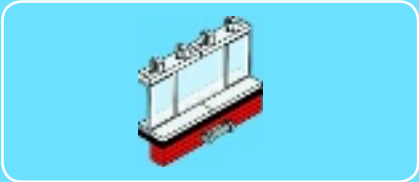

1x

1



2x

1x

2

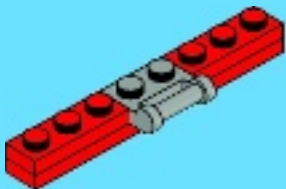

1x

3

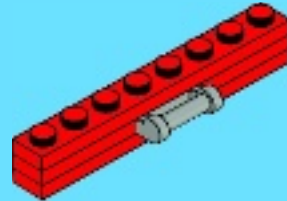

2x

4

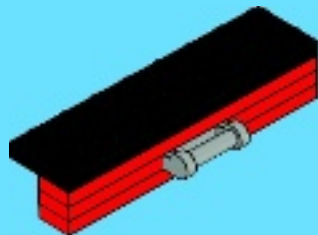

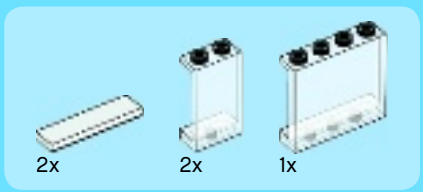

5

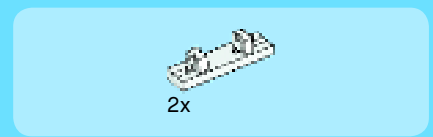
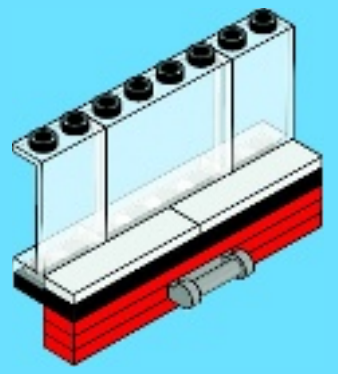

6

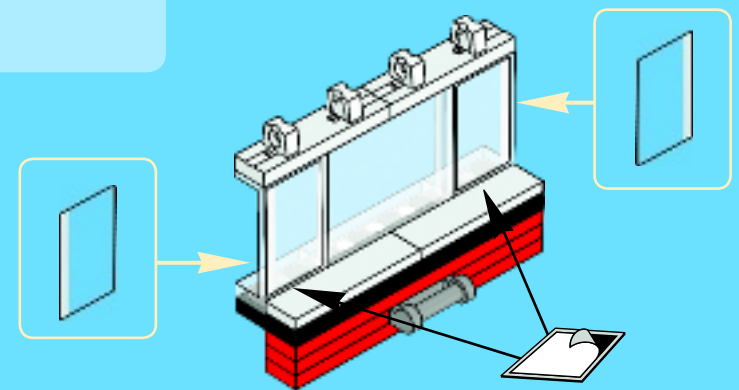

101

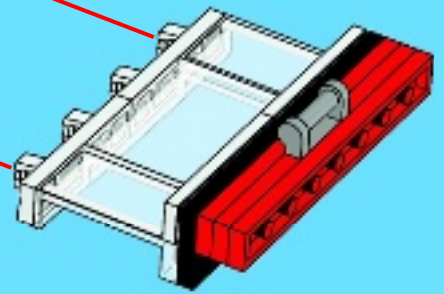
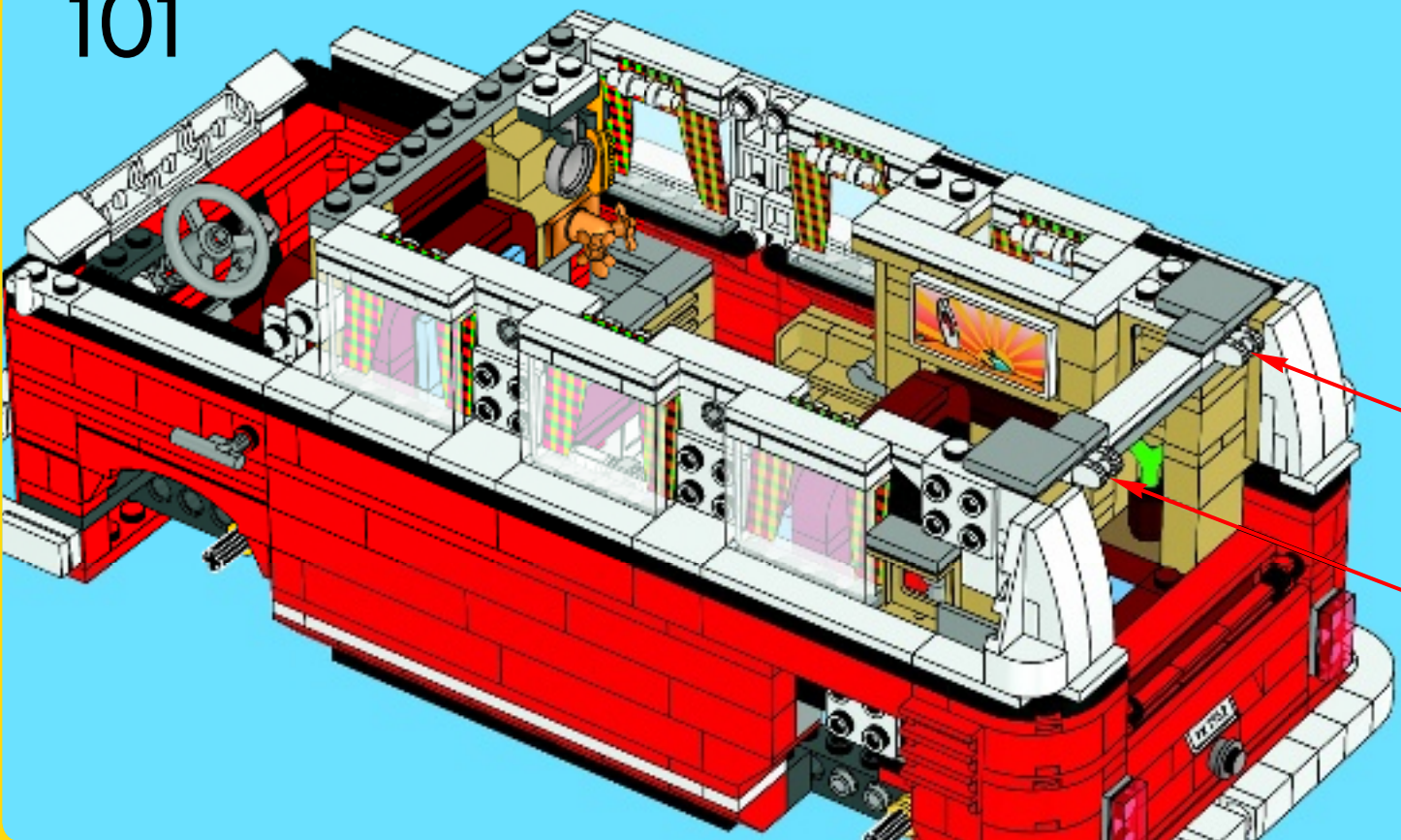

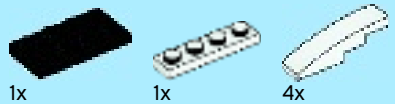

102

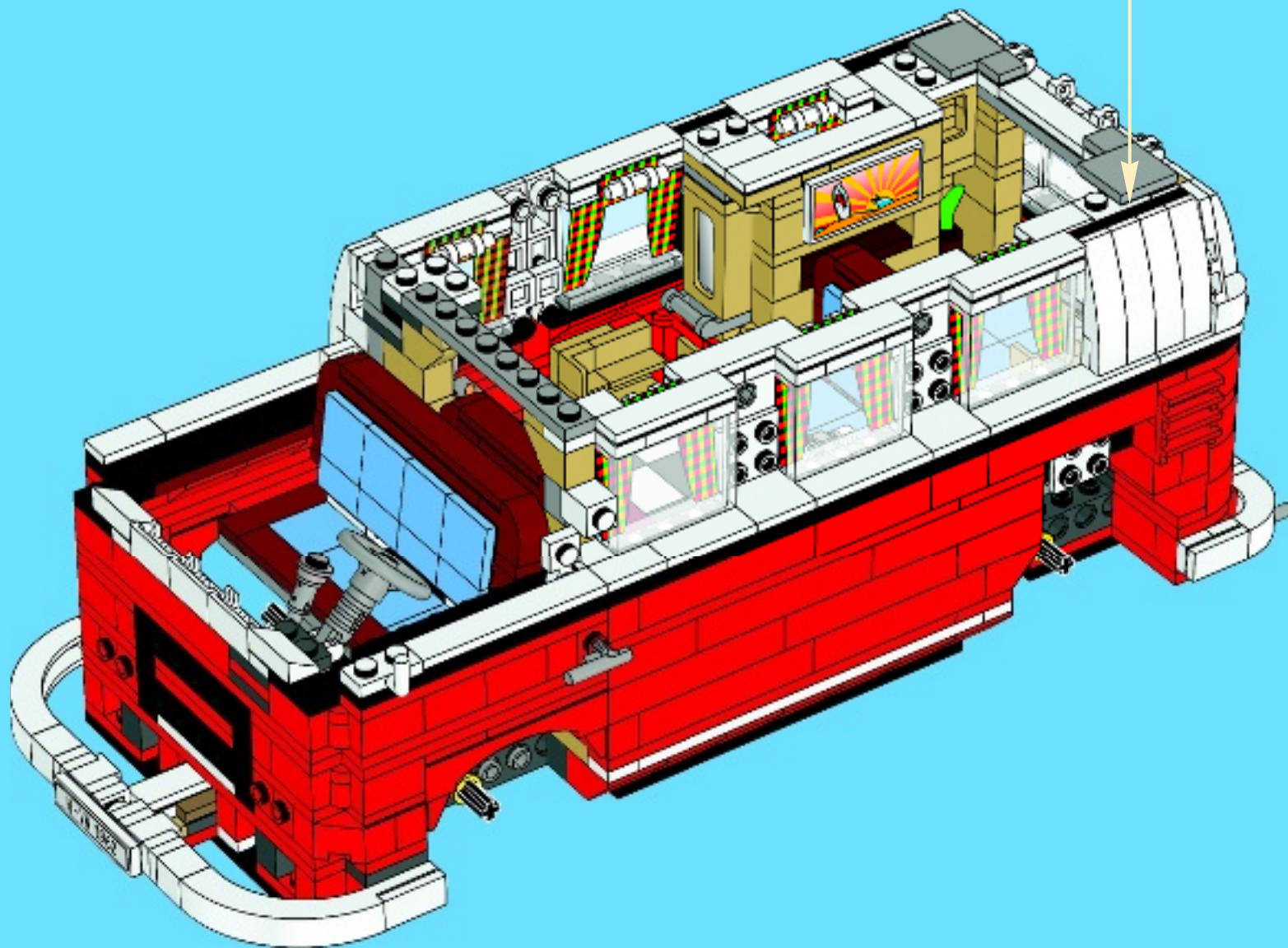

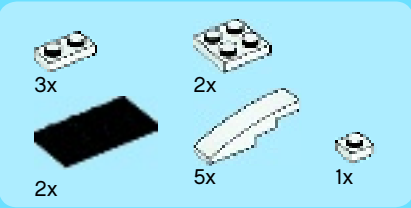

103

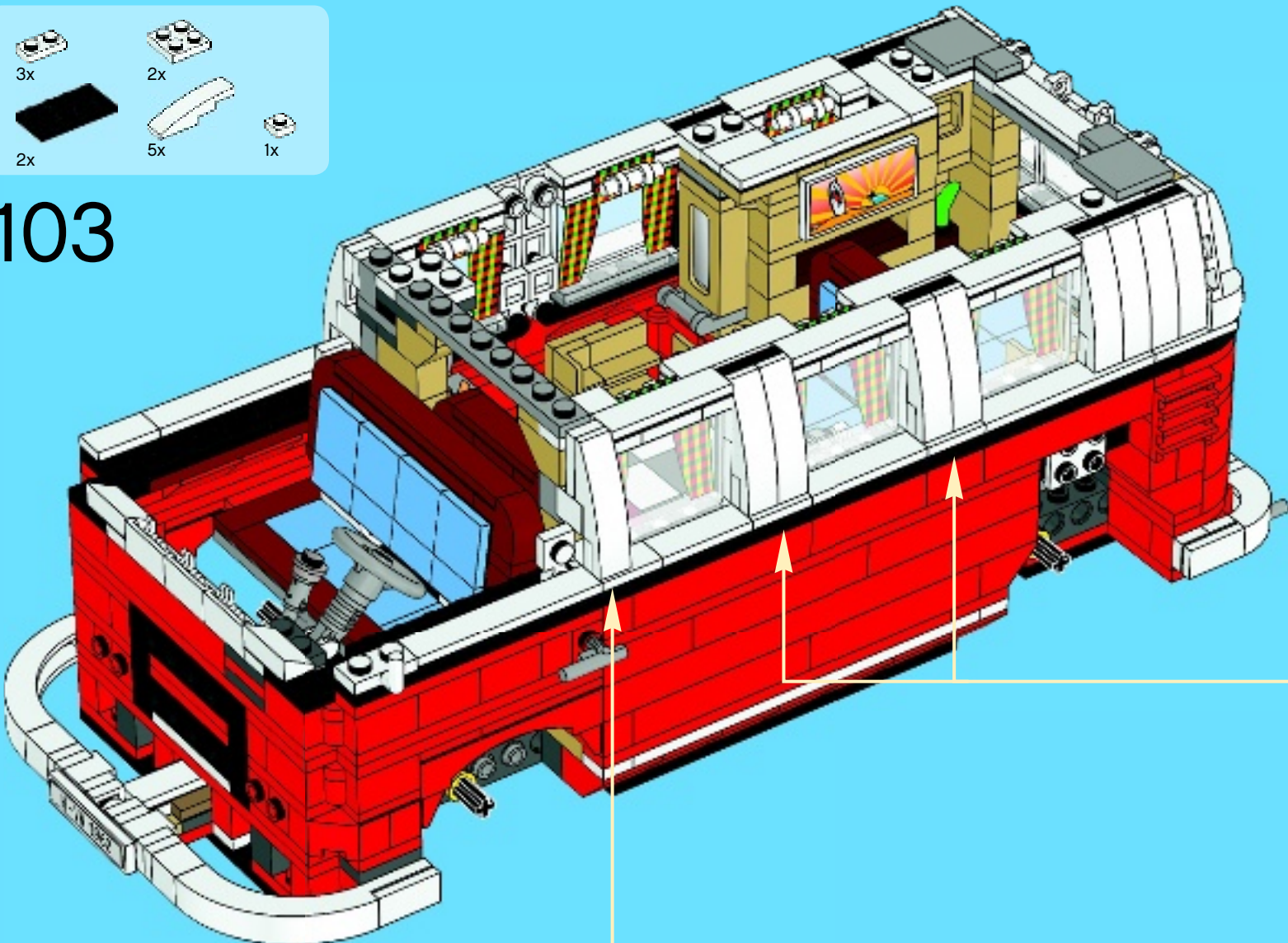

- 1
- 2
- 3

2x

- 1
- 2

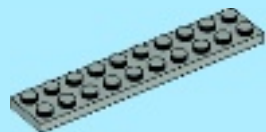

1x

1

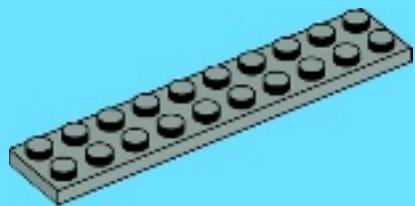

2

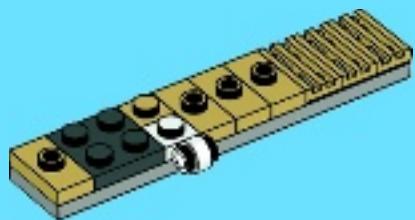

3x

3

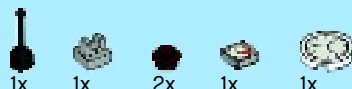
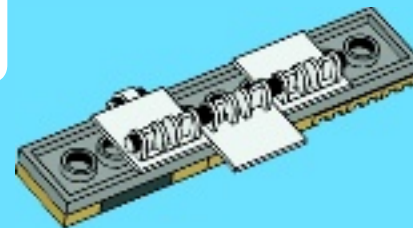

4

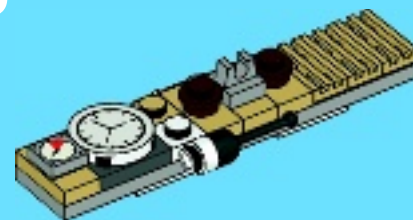

104

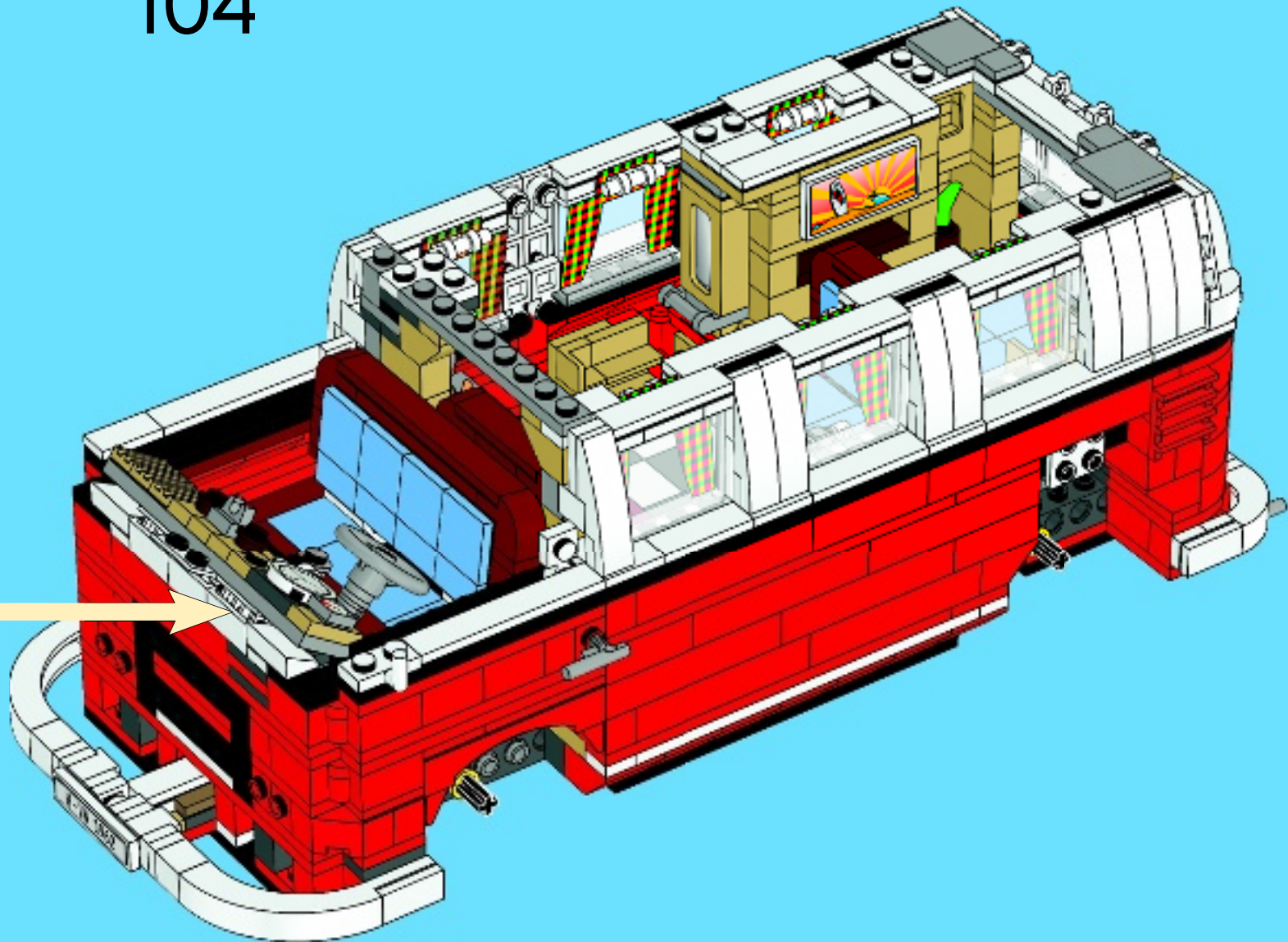



1

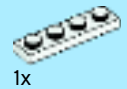
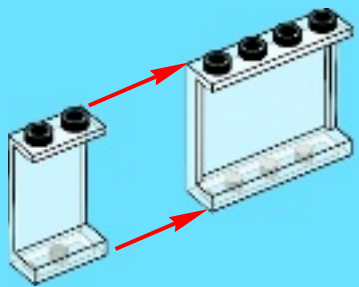

2

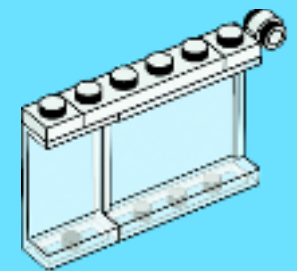

3

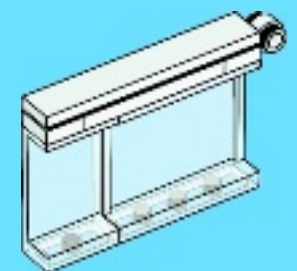

105

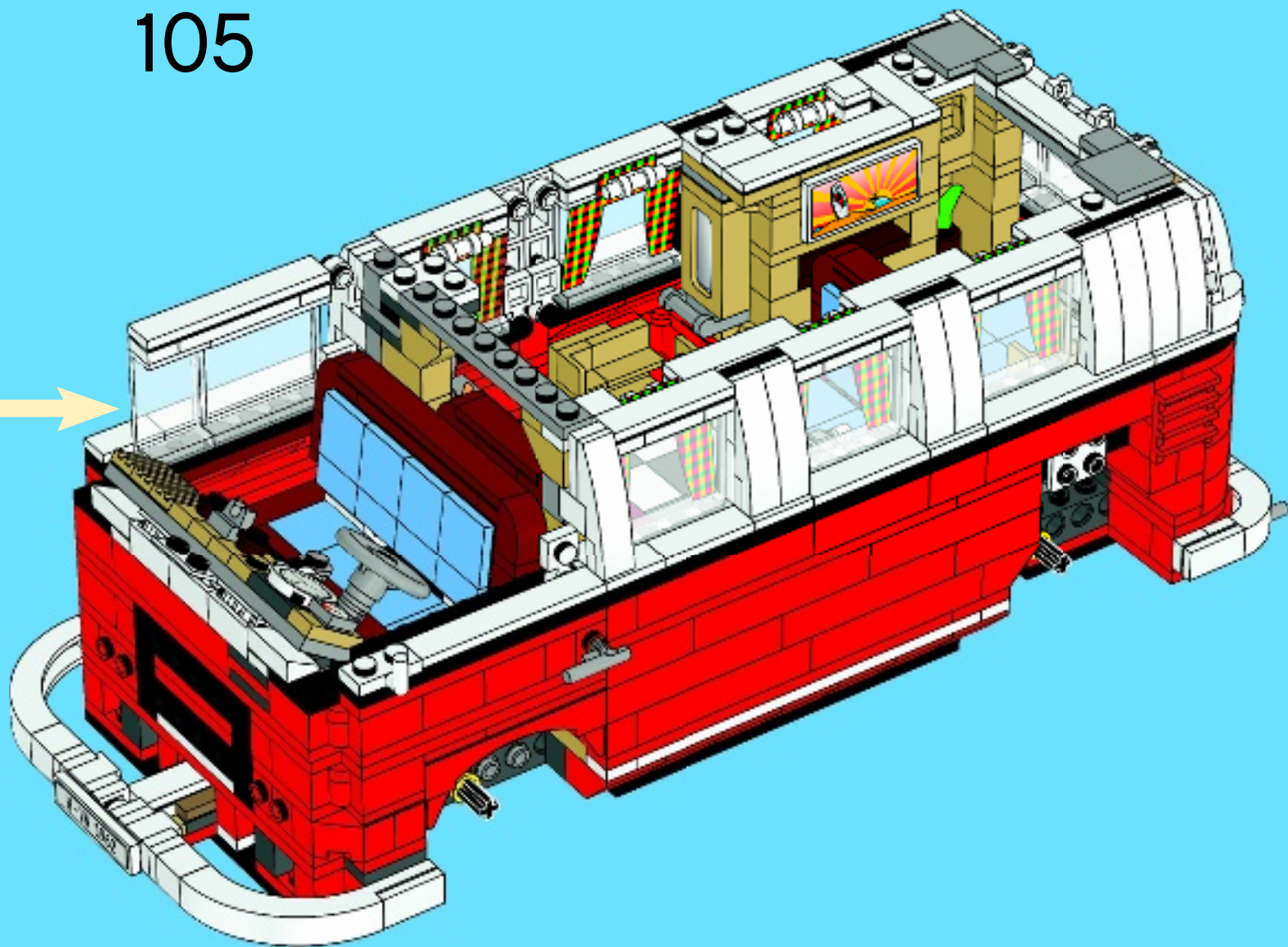

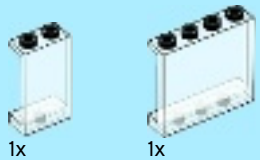

1

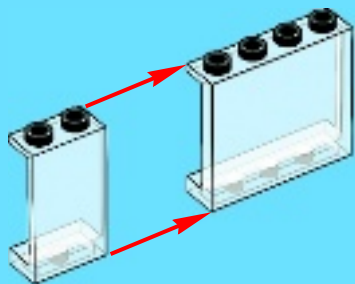

2

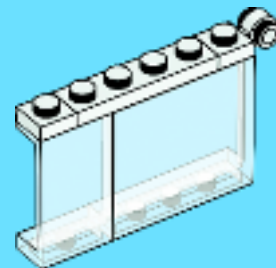

3



106

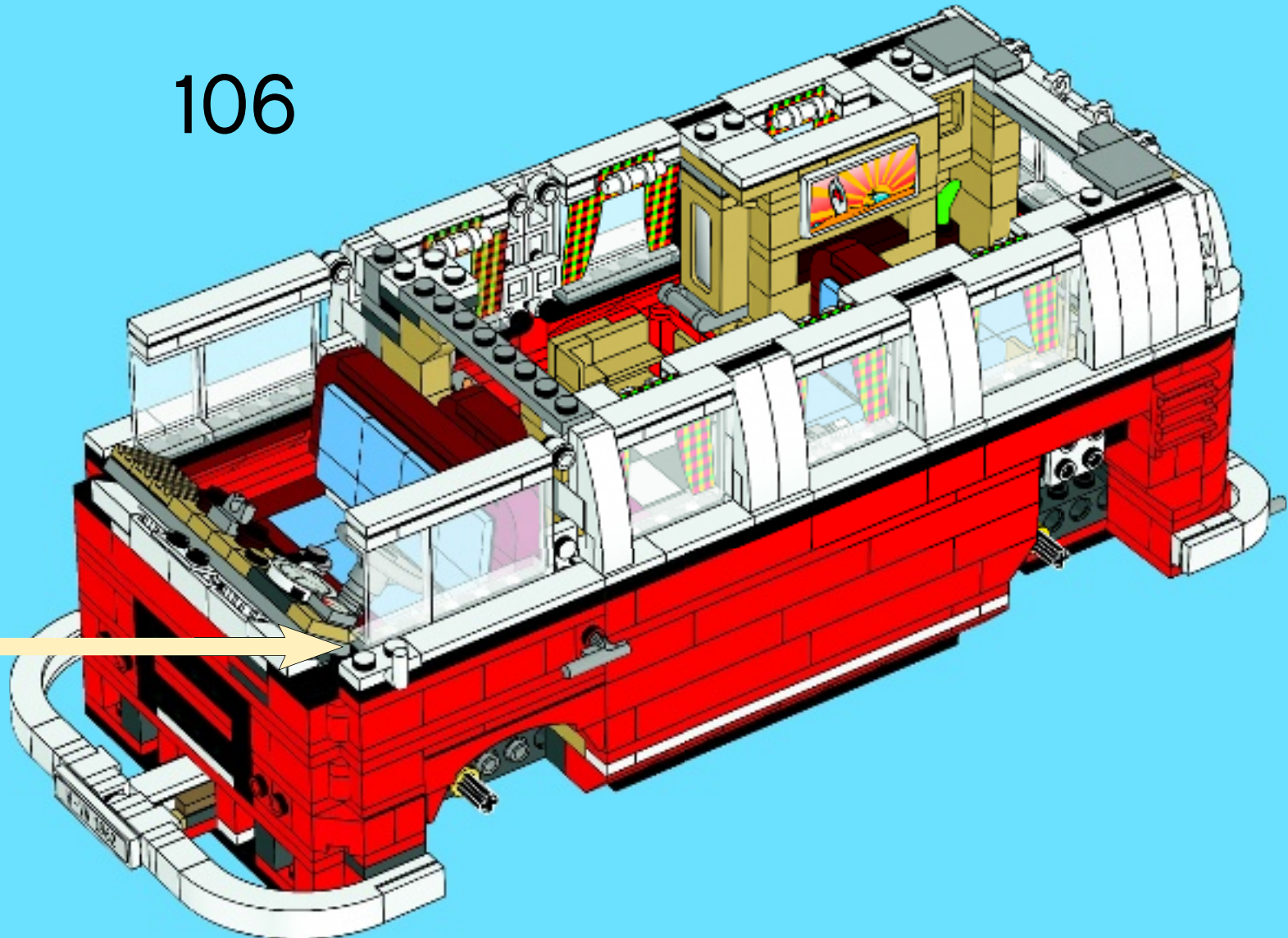

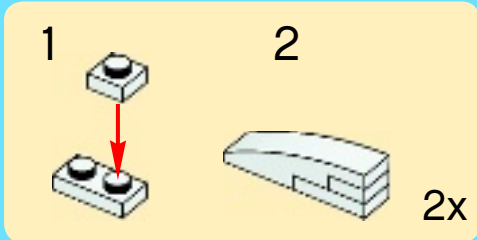
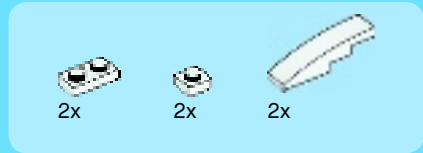

107

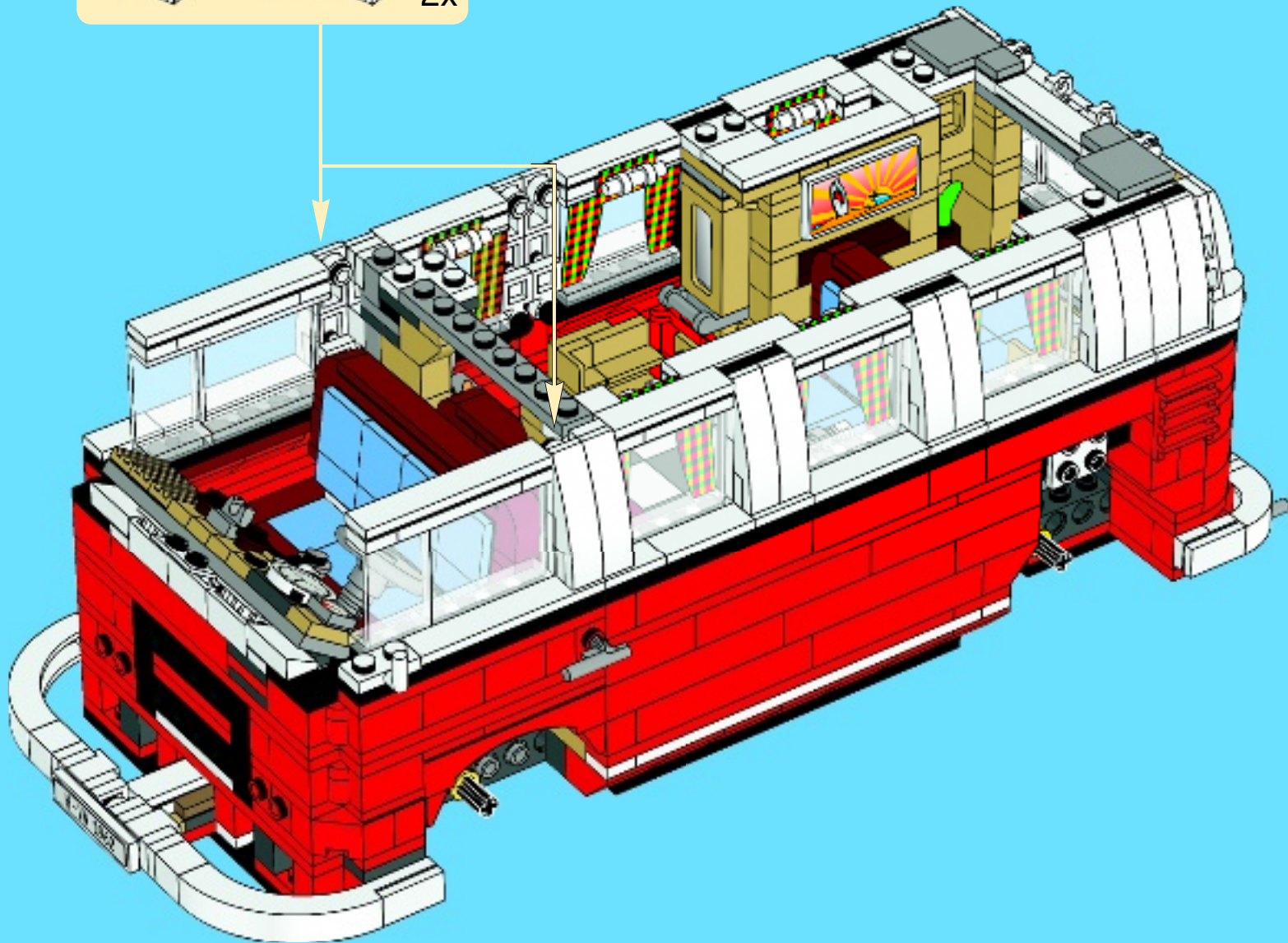

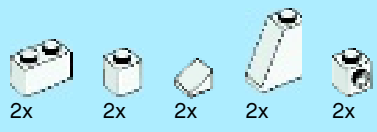

108

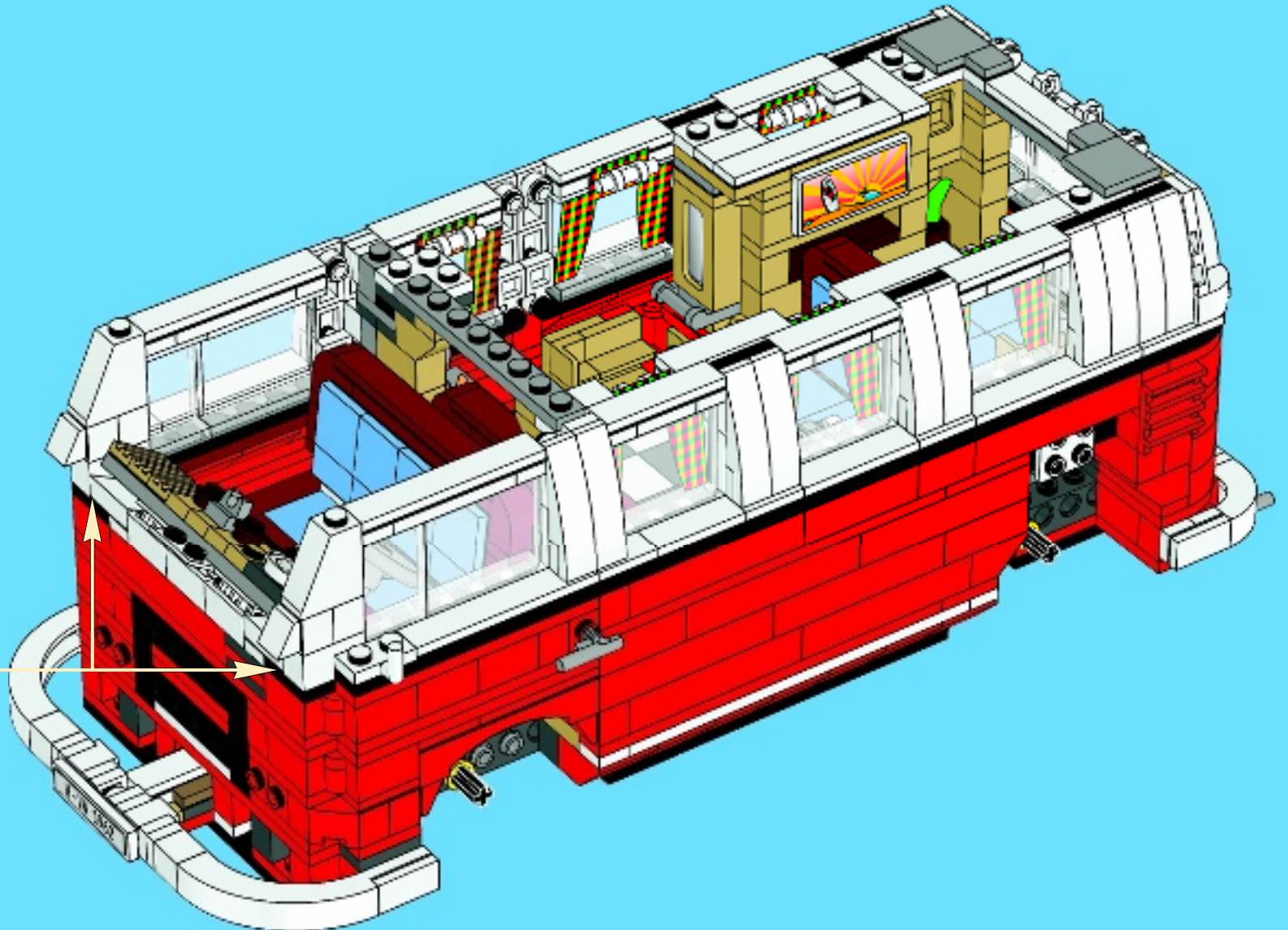
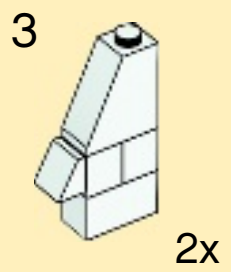
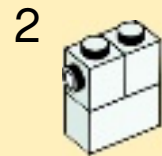
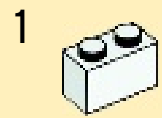

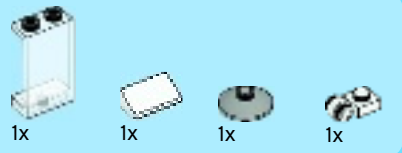

109

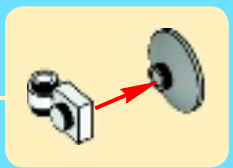
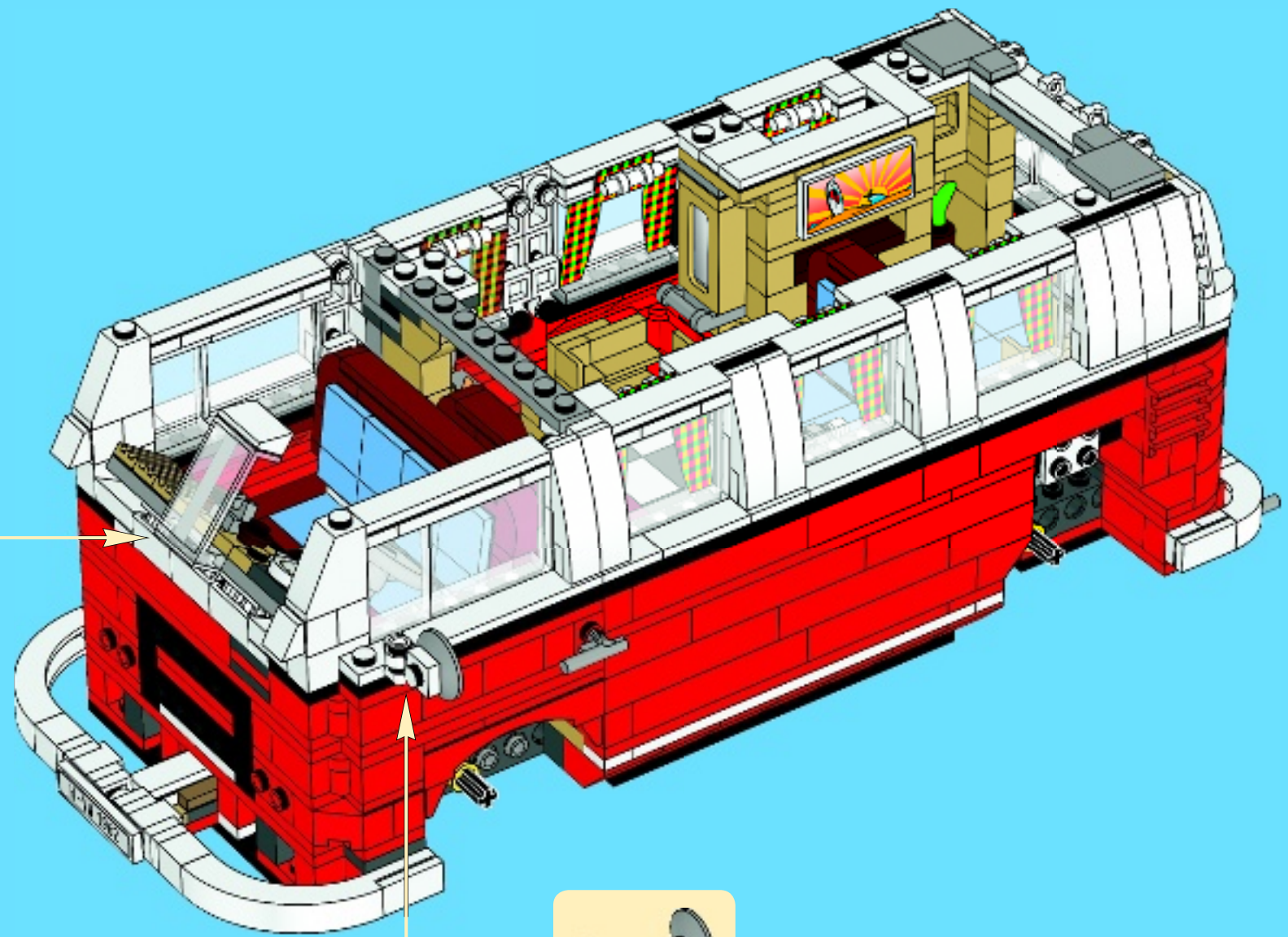
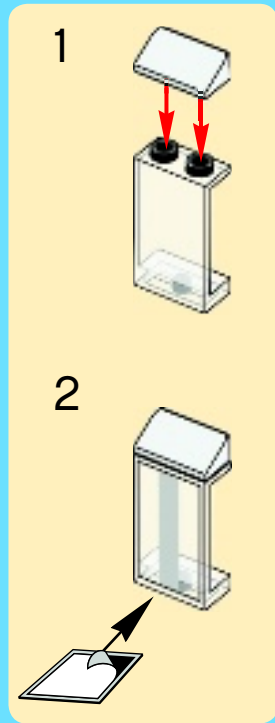

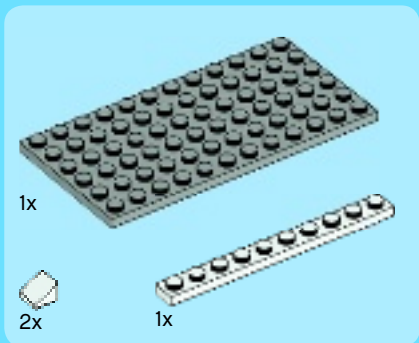
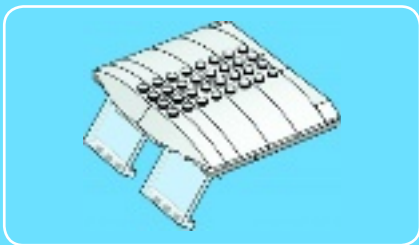

1

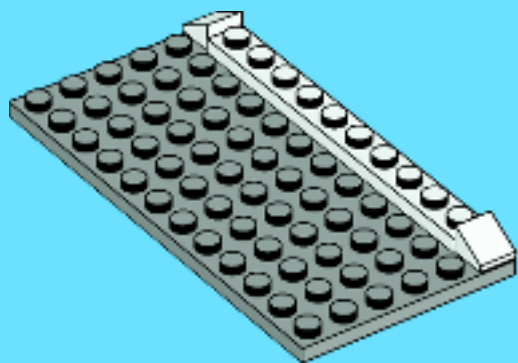

2

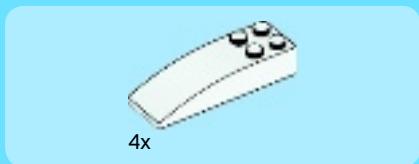
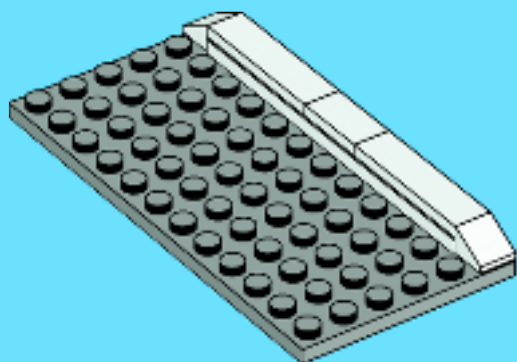

3

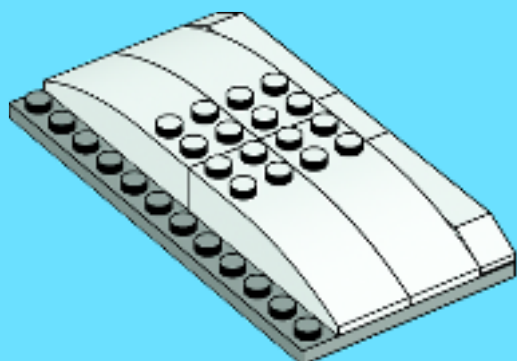



2x

4

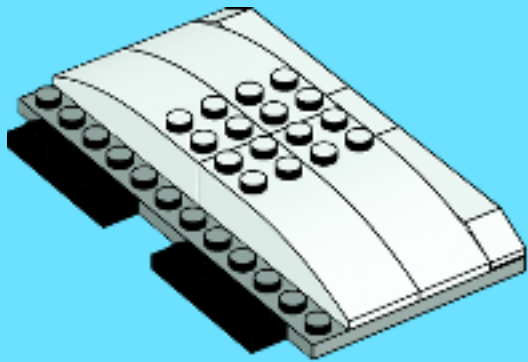

2x

5

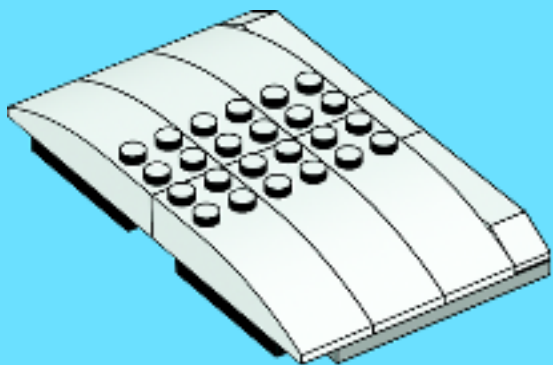

1x



2x

6

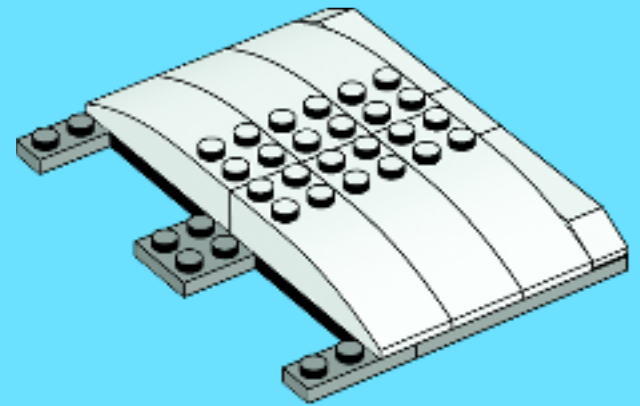

2x



1x



1x

7

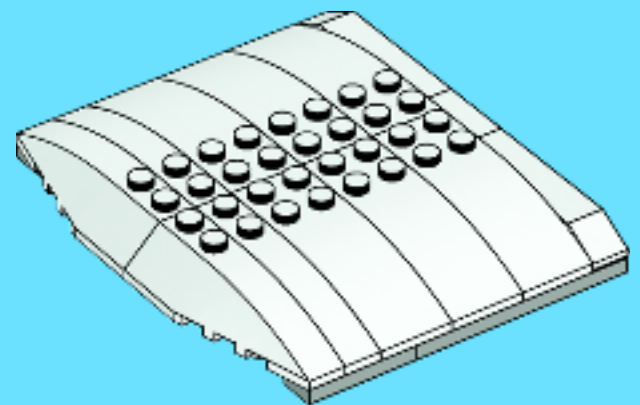



8

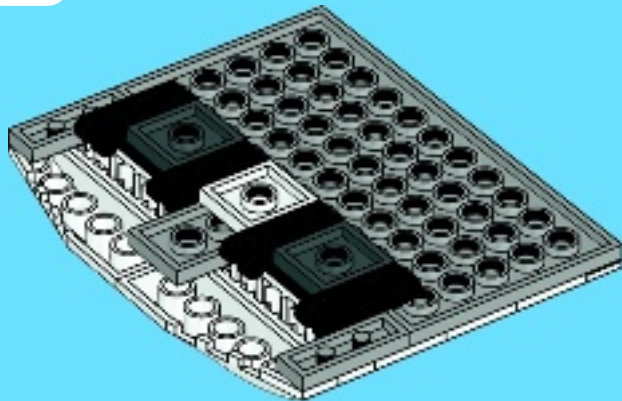

9

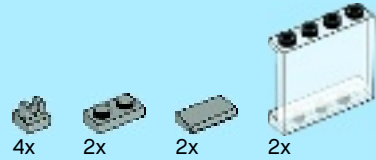
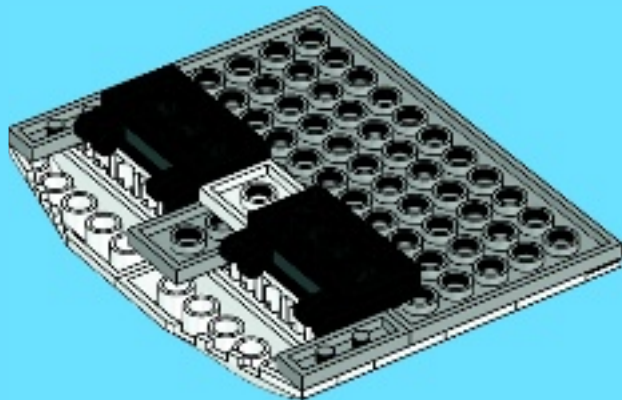

10

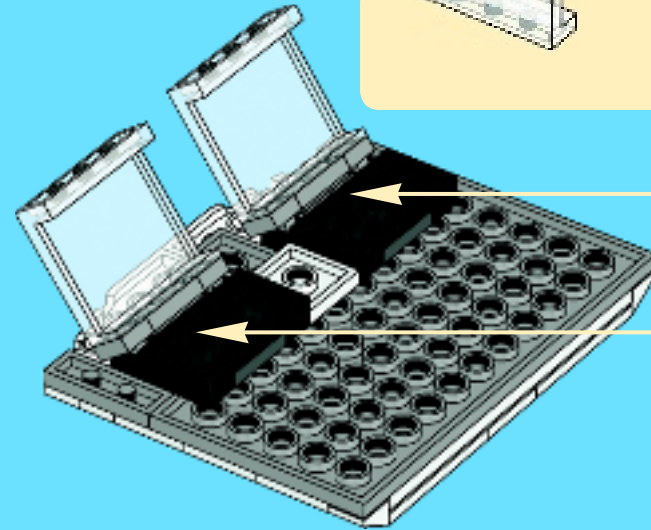
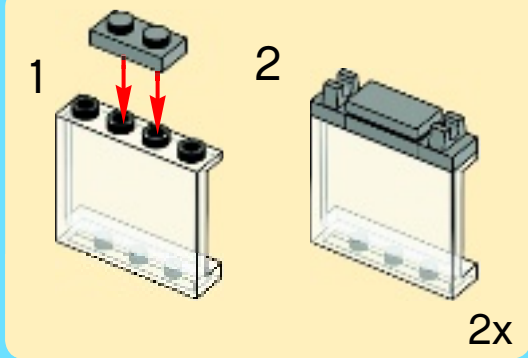

11

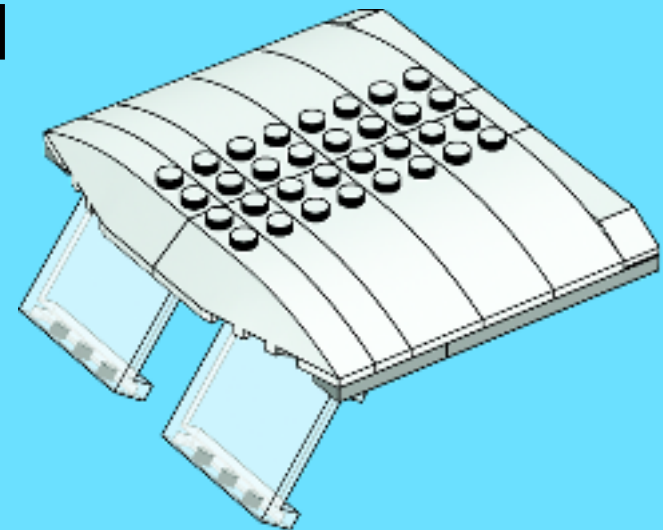

110

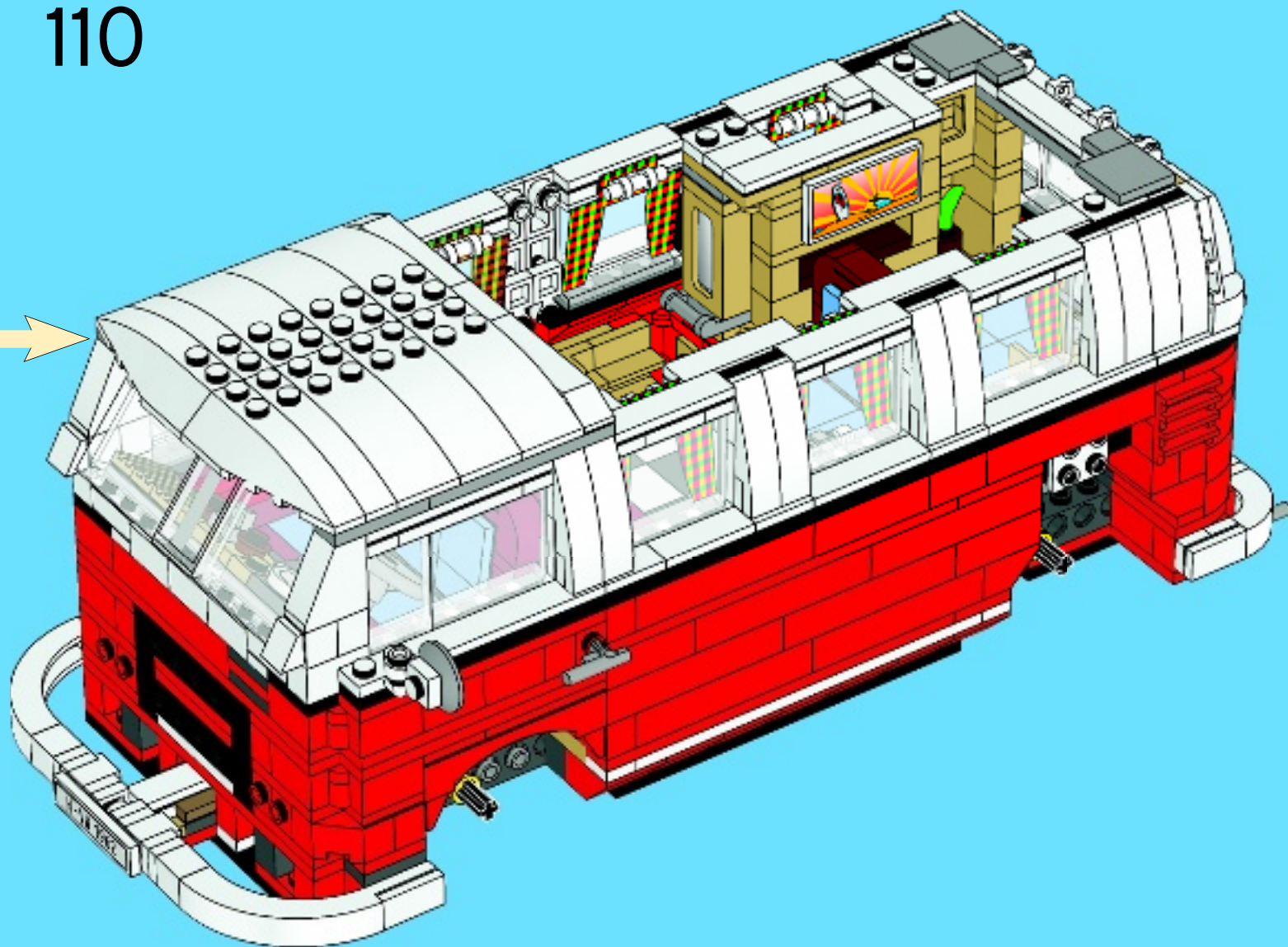

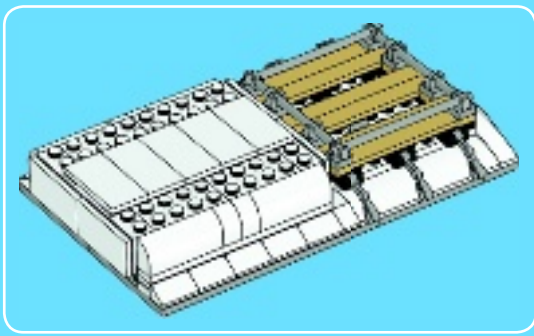

2x

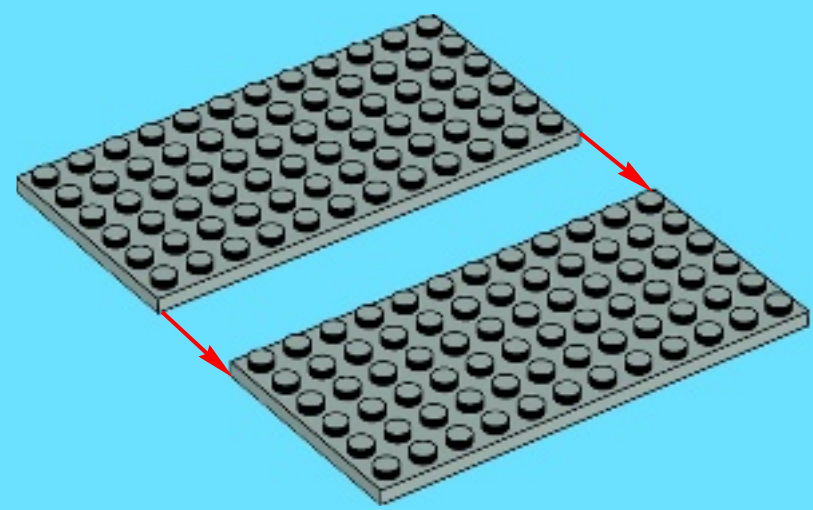

1

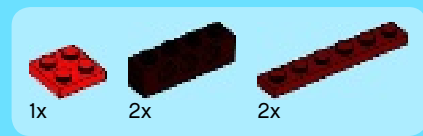

1x

2x

2x

2

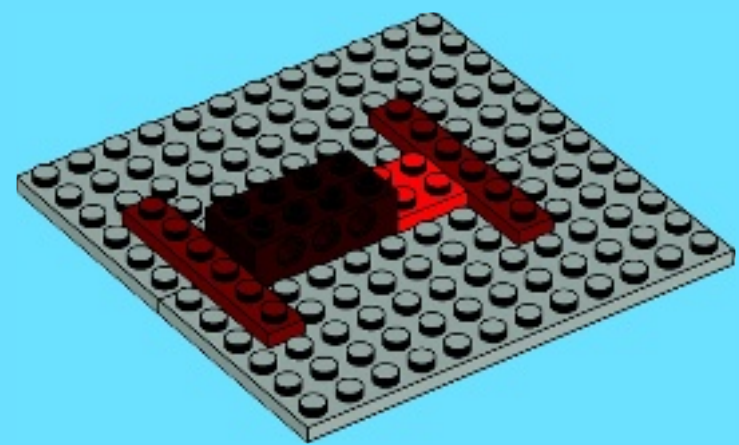

2x



4x



2x

3

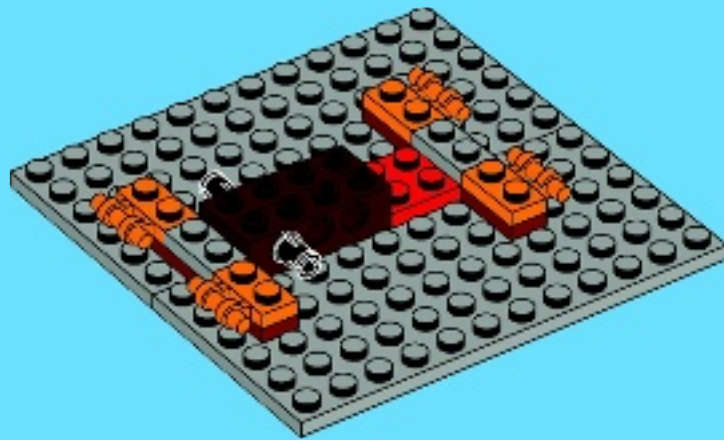

2x



2x

4



2x



2x



10x

5

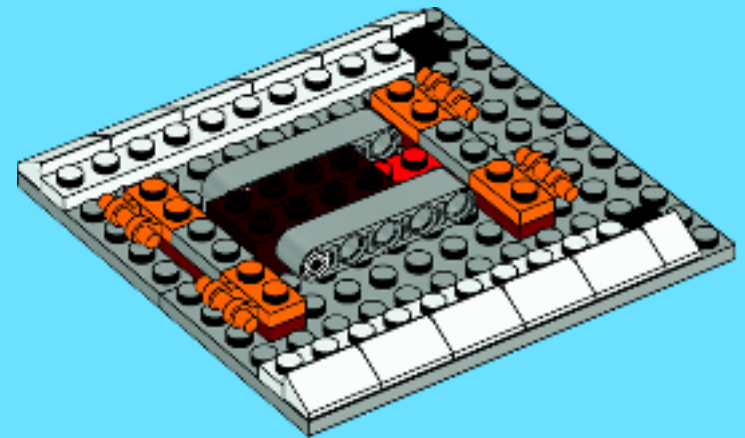

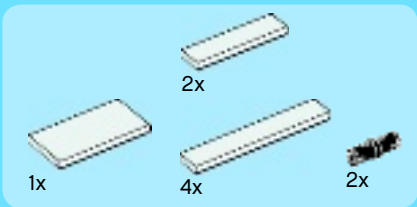

6

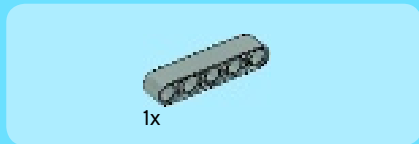
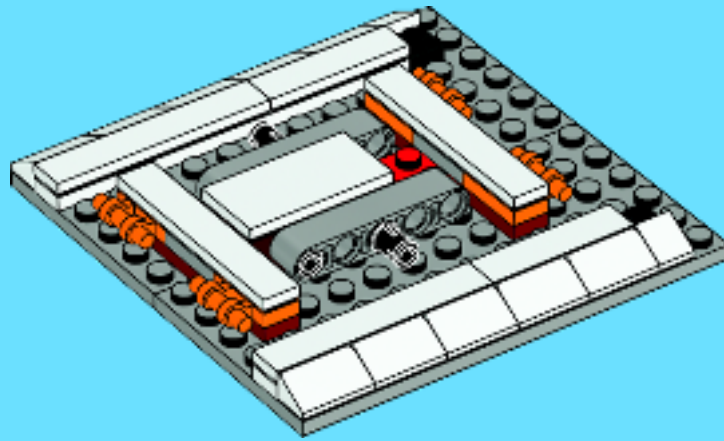

7

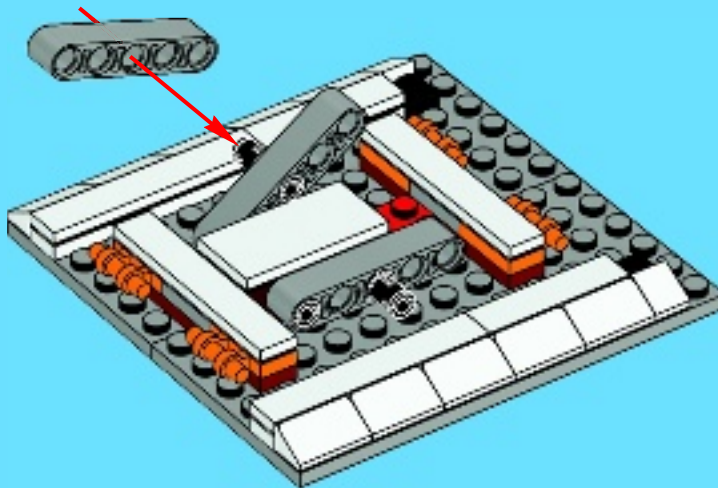



1x

8

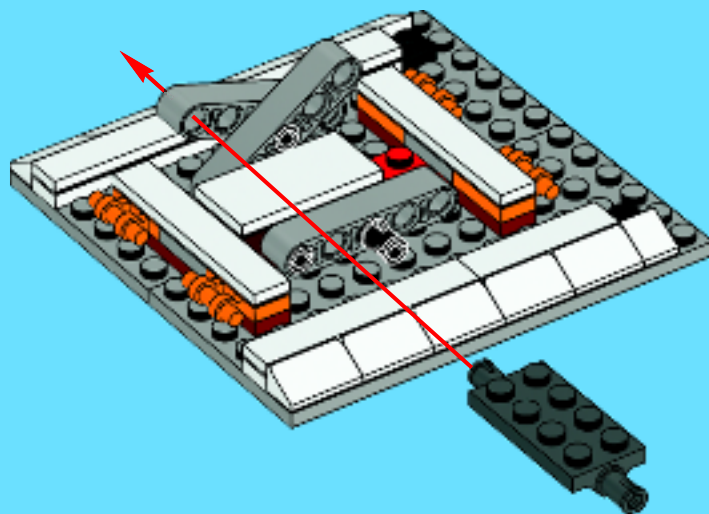

1x

9

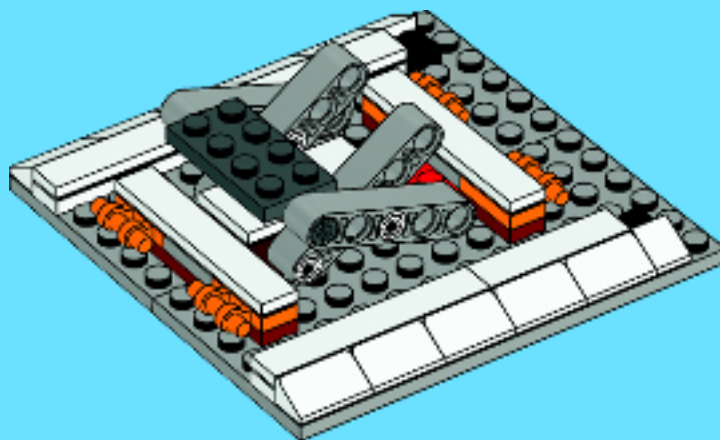

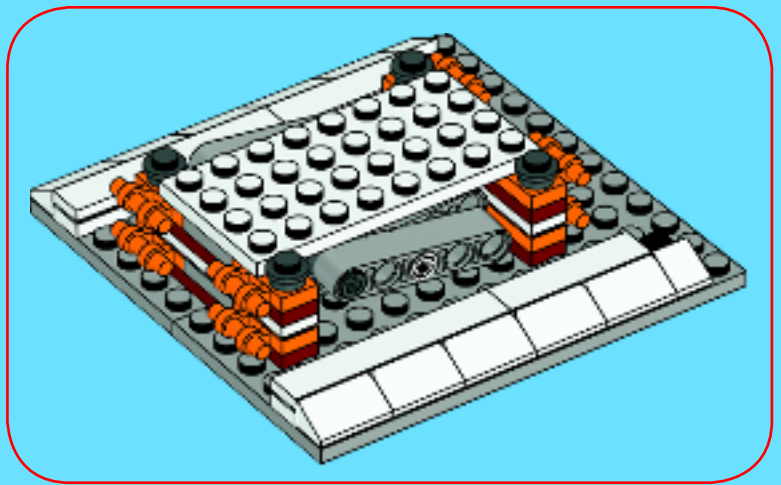
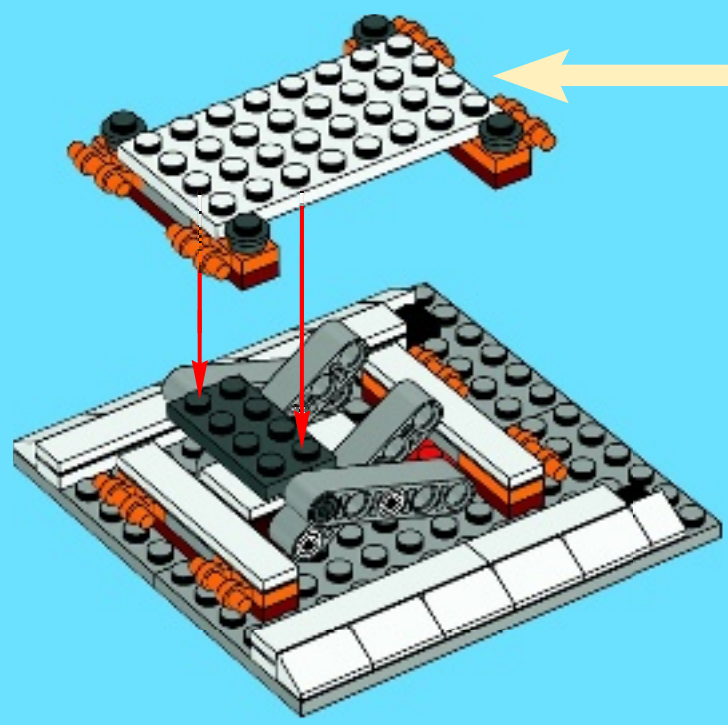
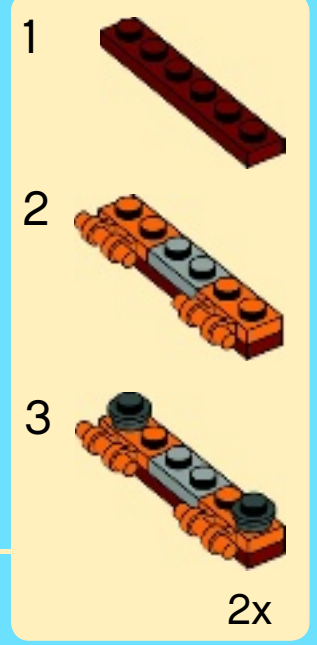
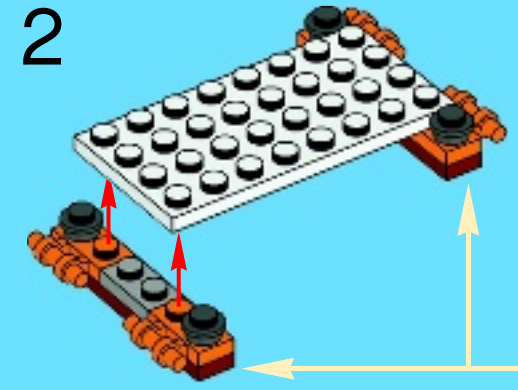
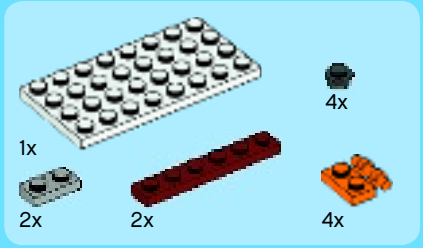

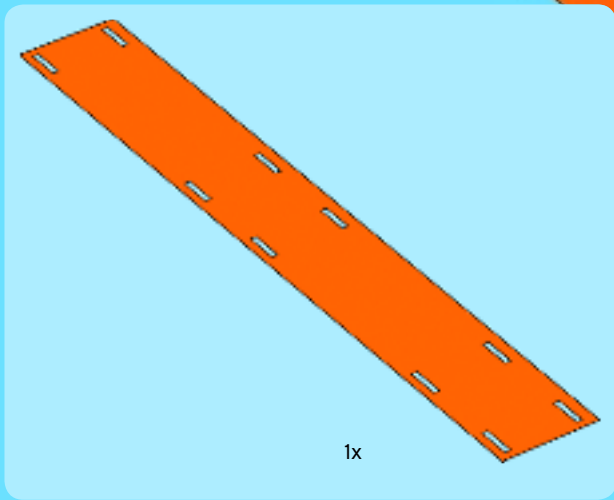

11

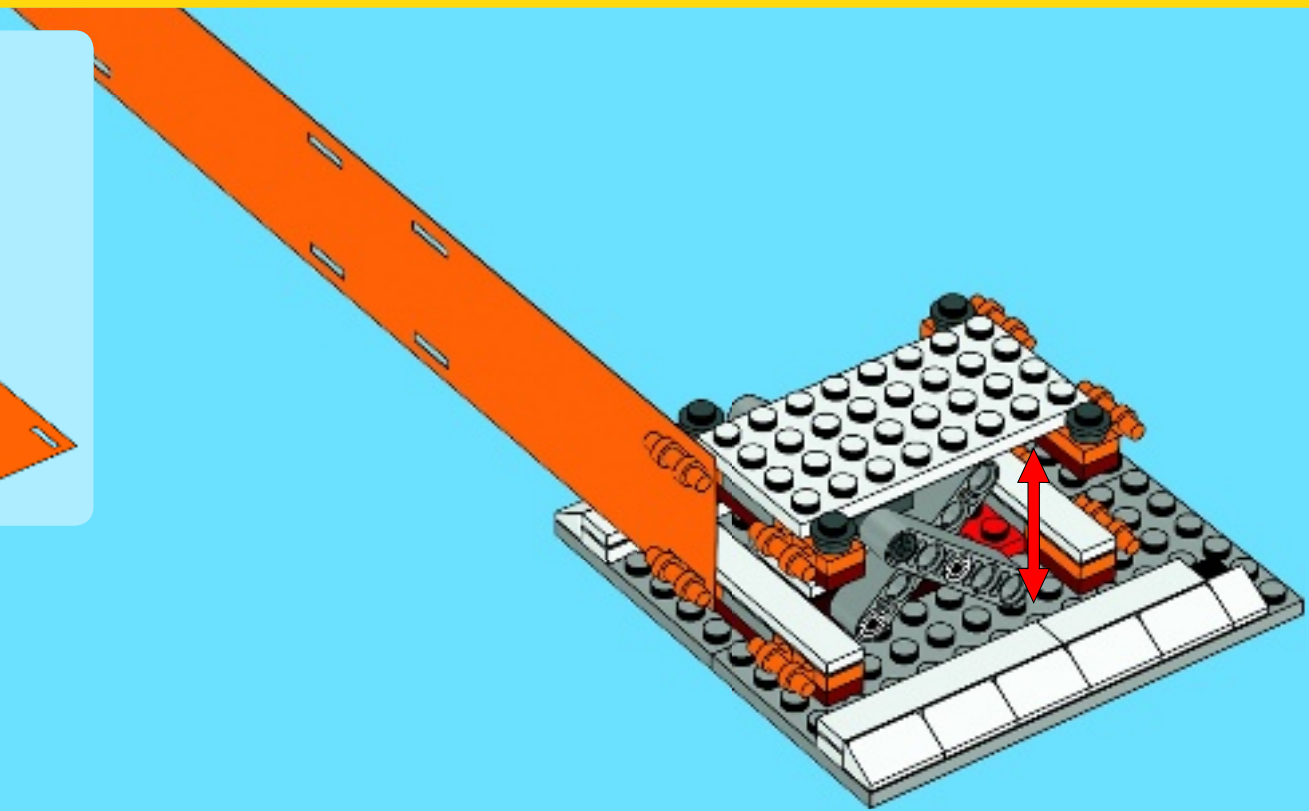

12

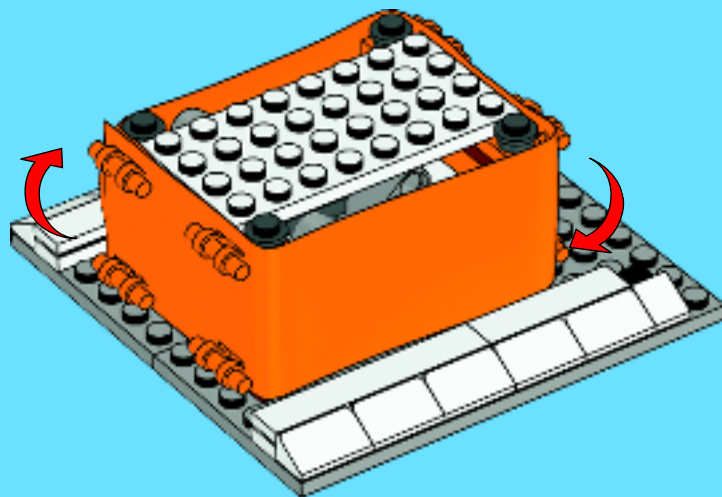

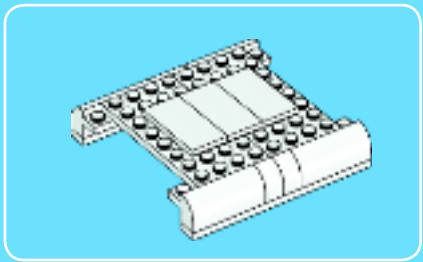

1

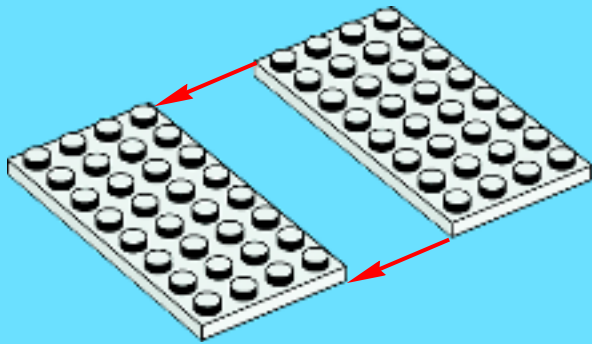

2

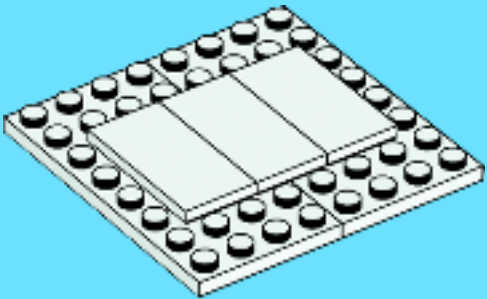

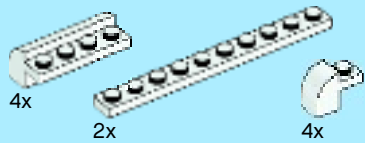

3

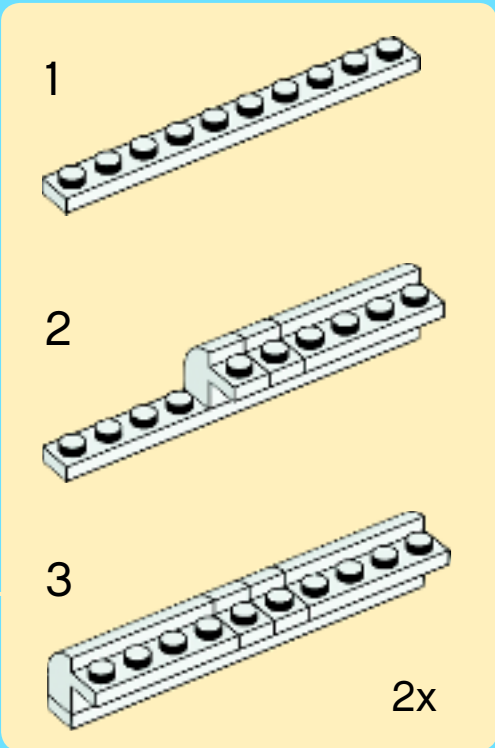
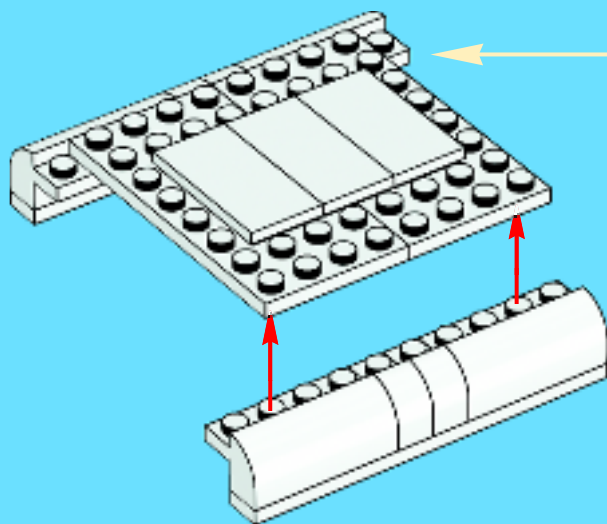

13

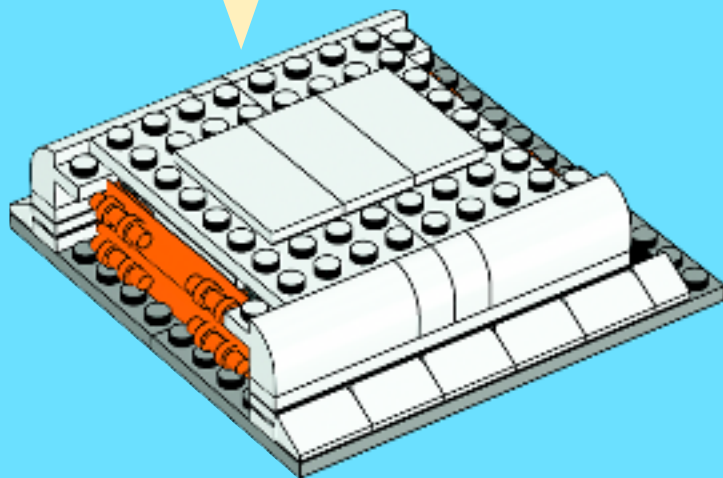

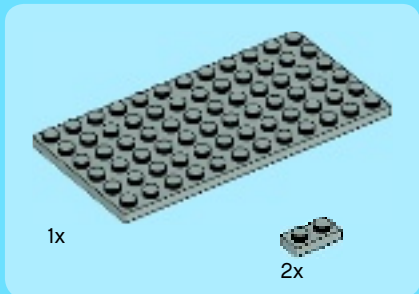
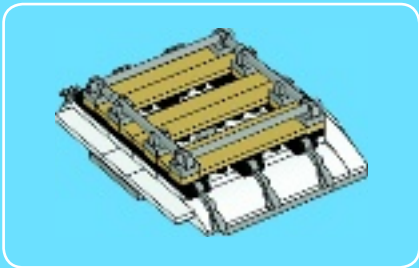

1

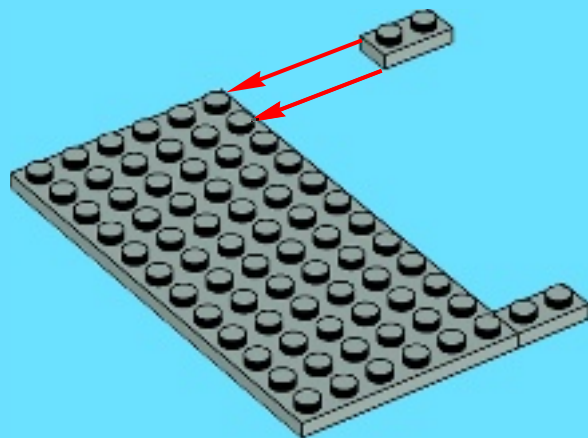

2

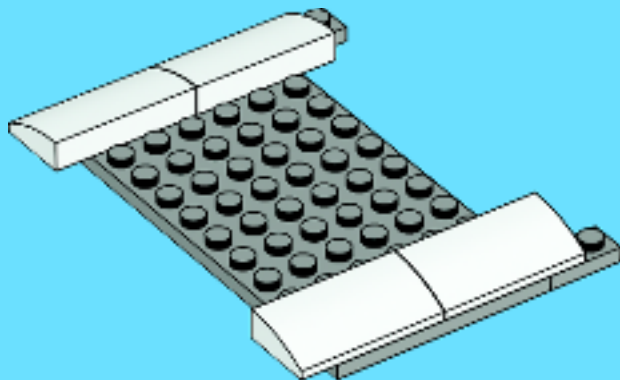



1x

3

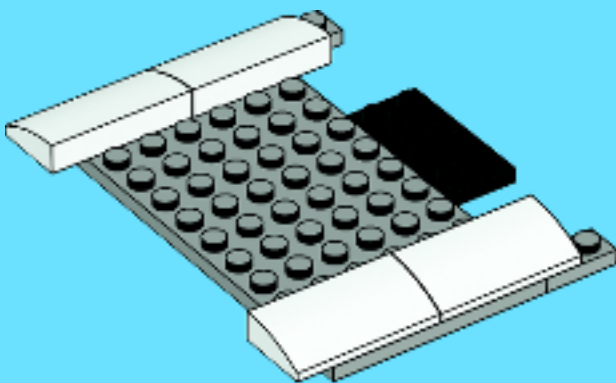

1x



1x

4

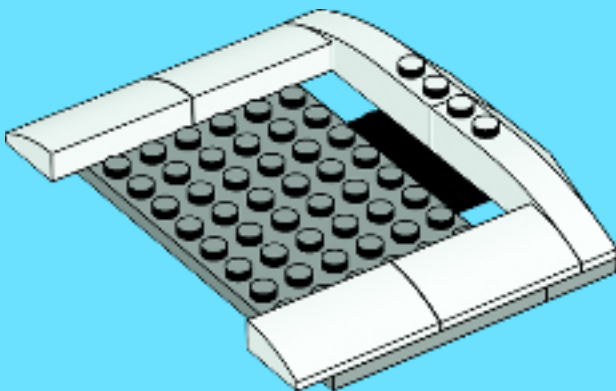

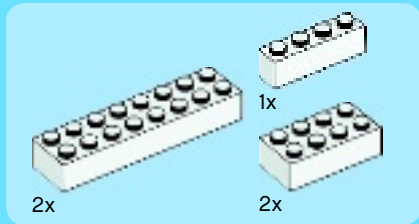

5

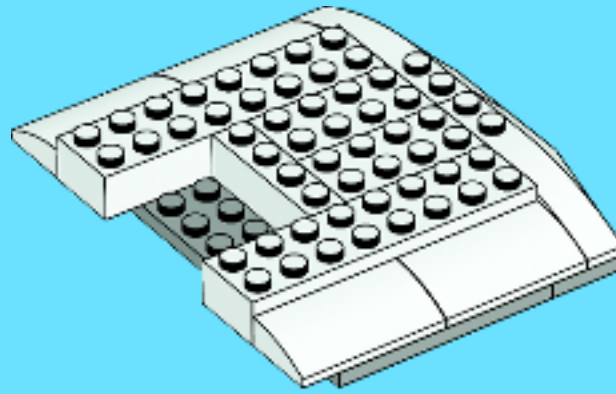

6

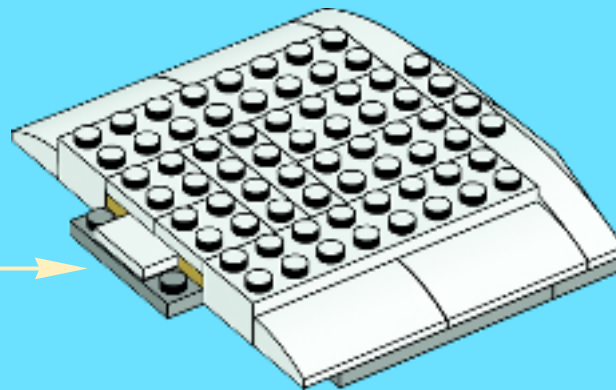
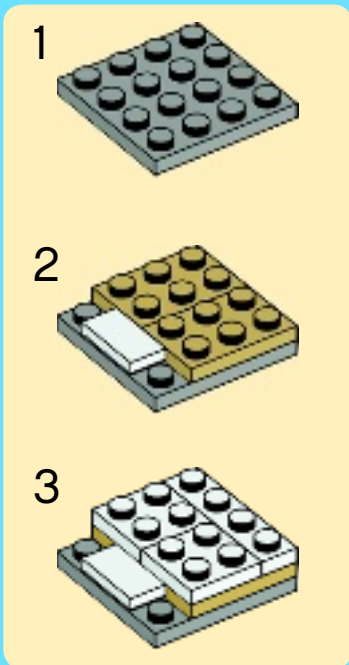



3x



1x



6x

7

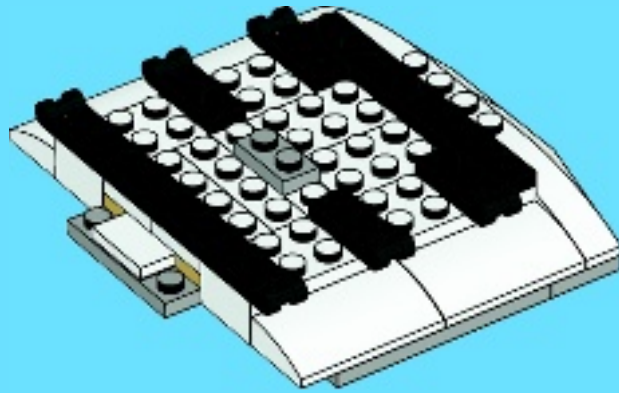

8x

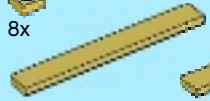

4x



2x



6x

8

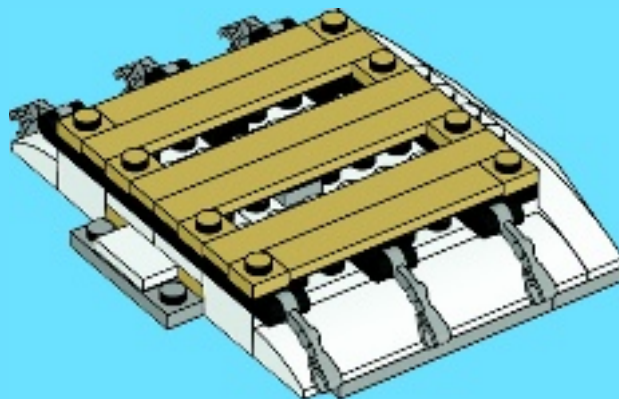

8x

9

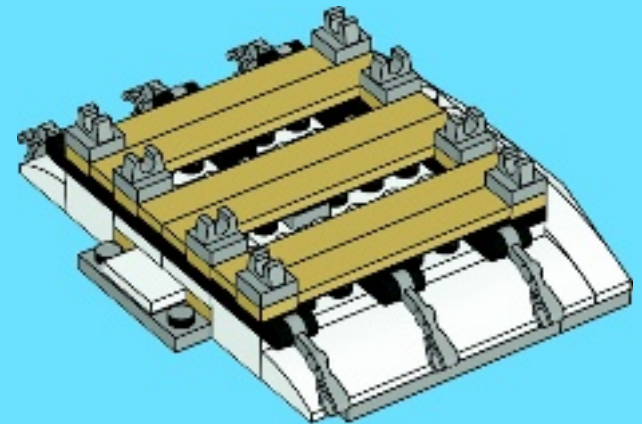

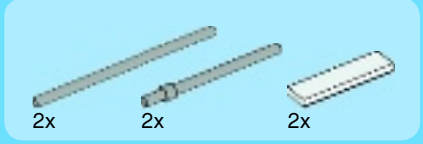

10

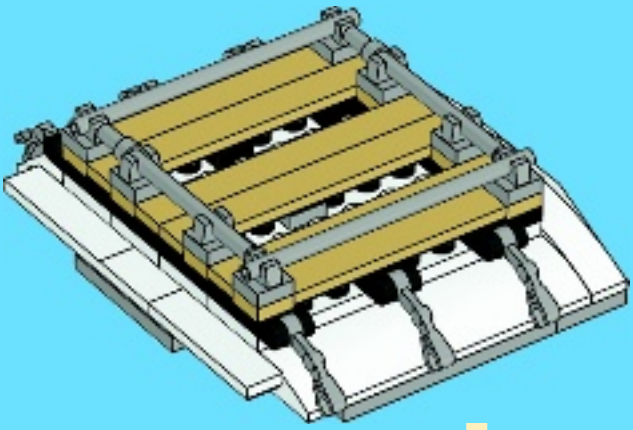

14

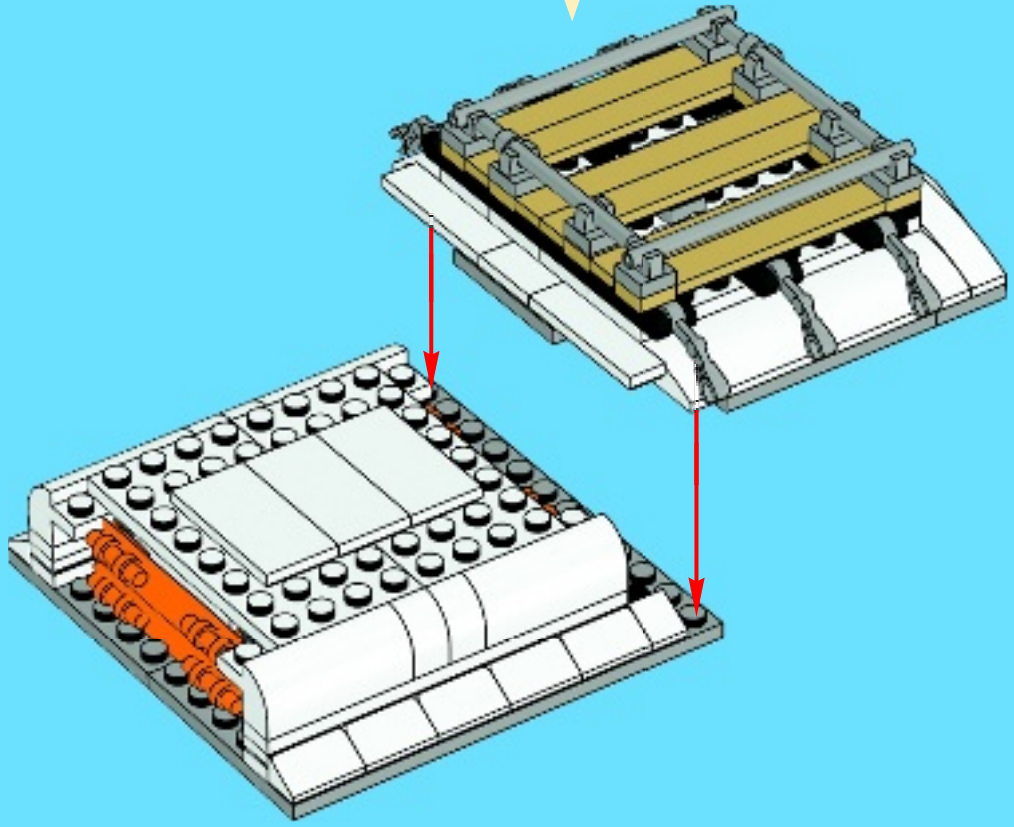

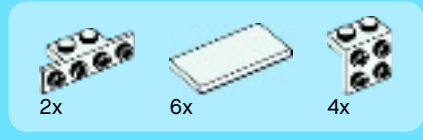

15

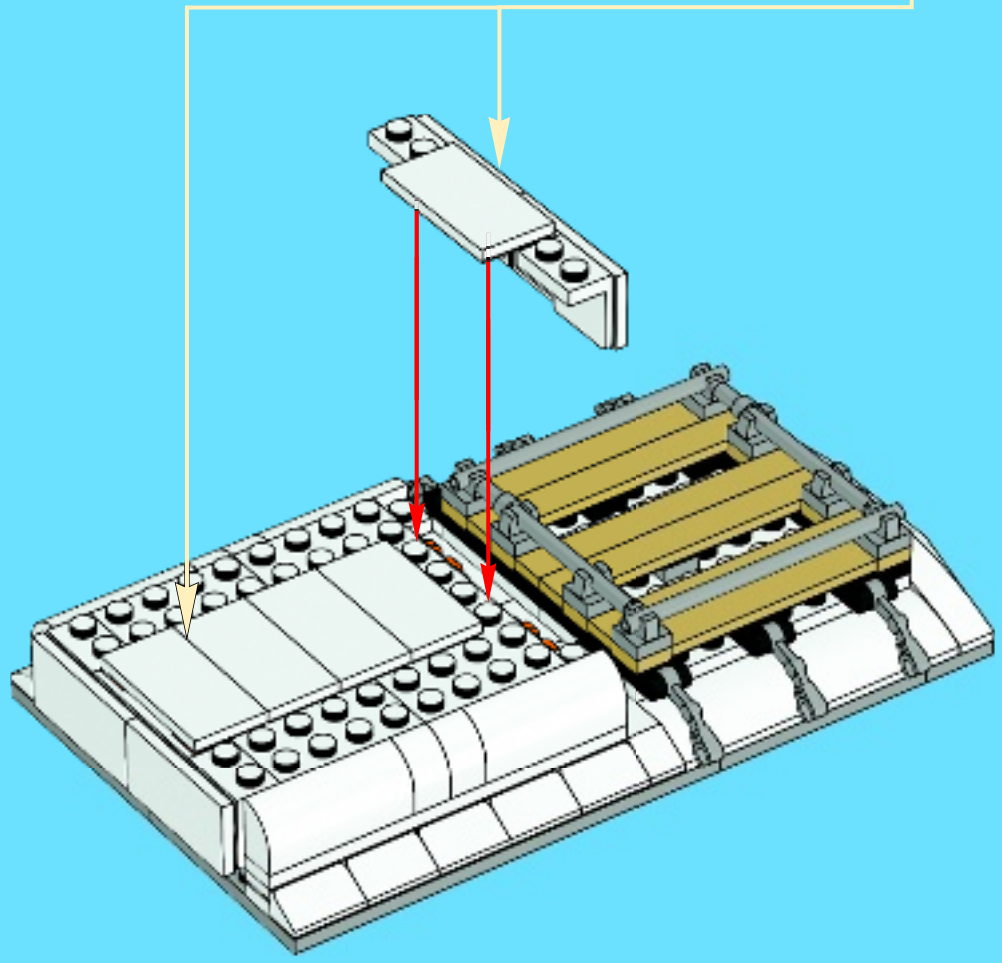
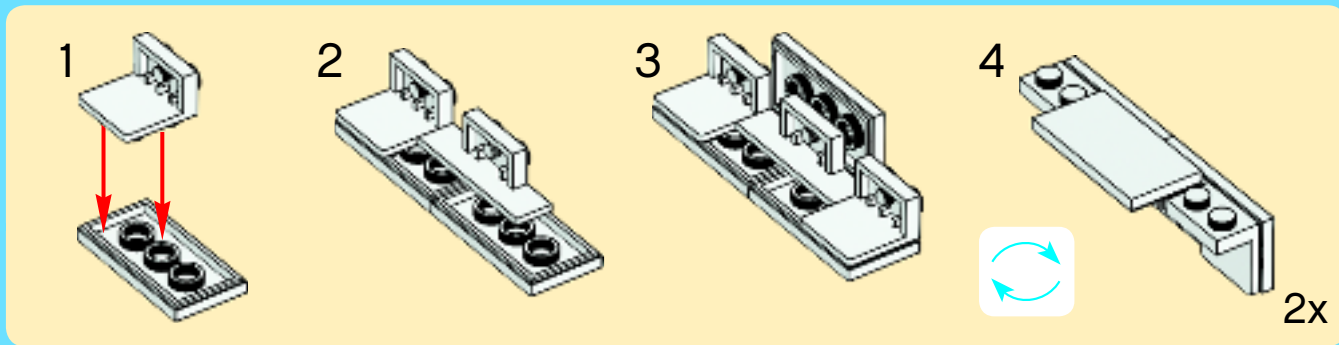



1x

16

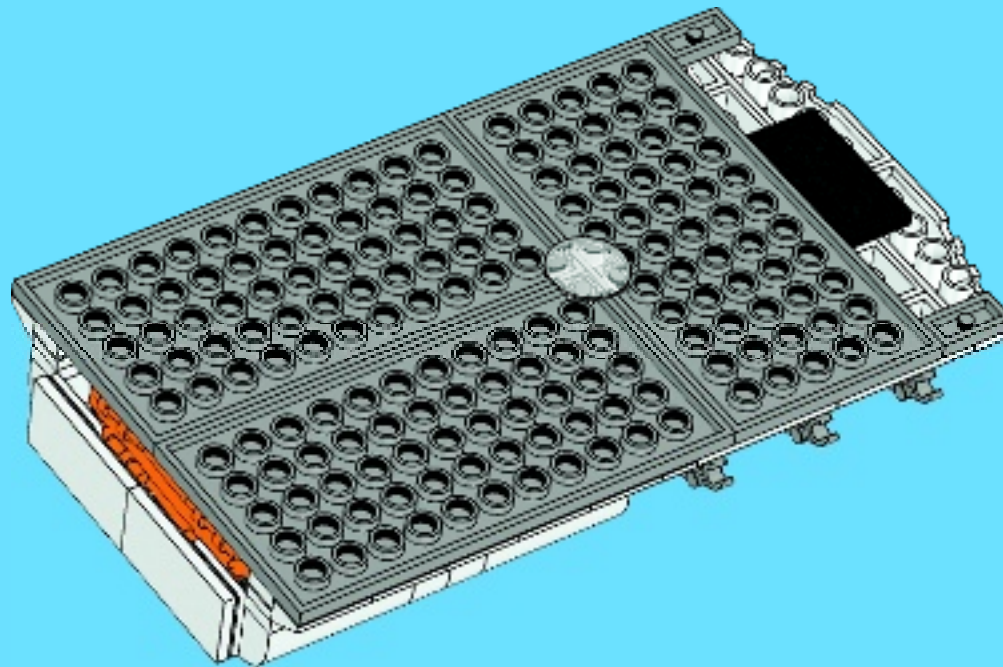

111

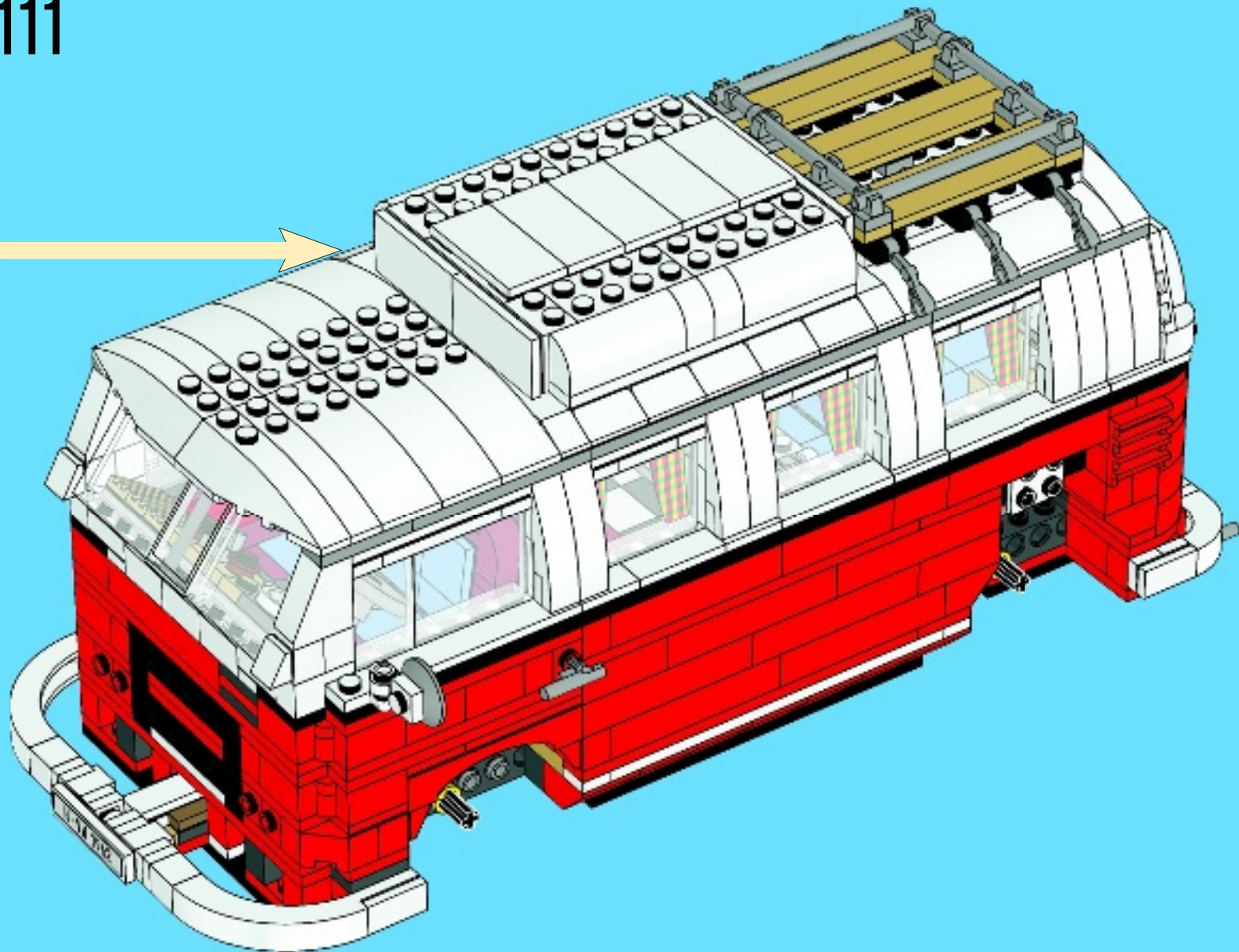

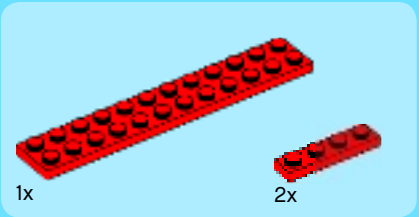

1

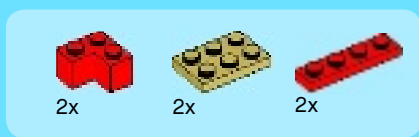
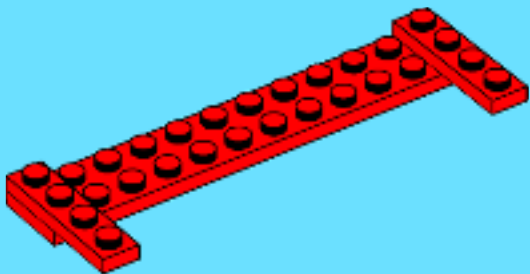

2

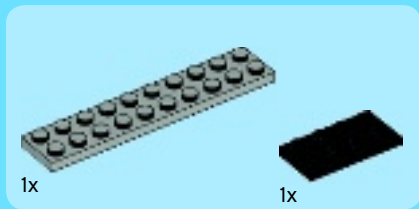
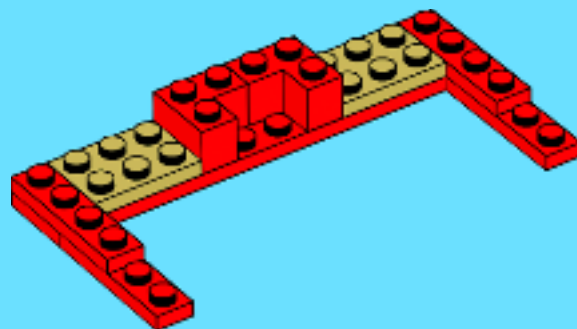

3

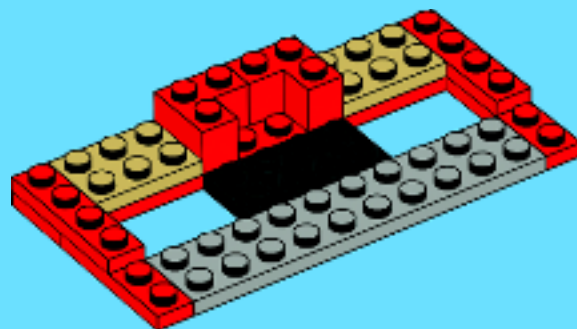



4

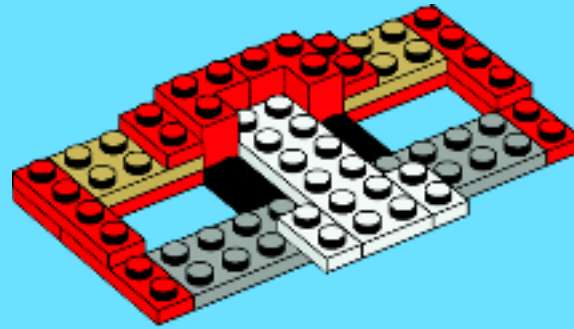

5

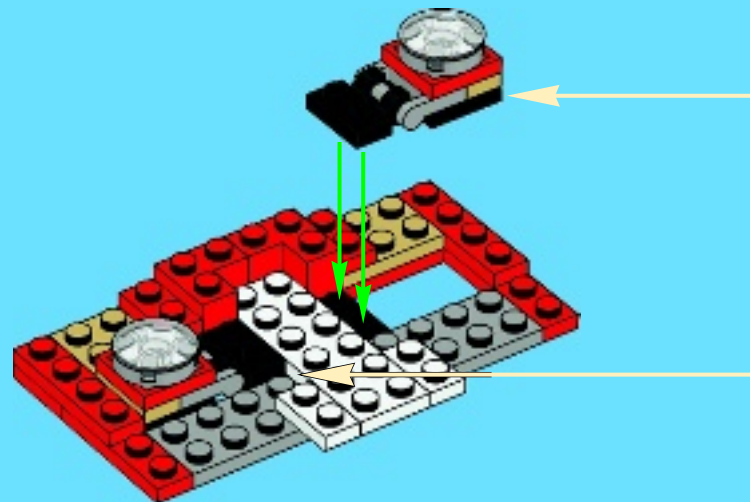

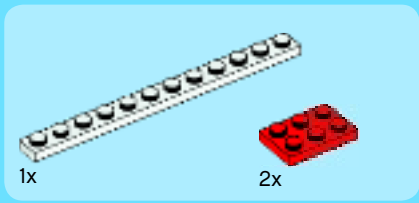

6

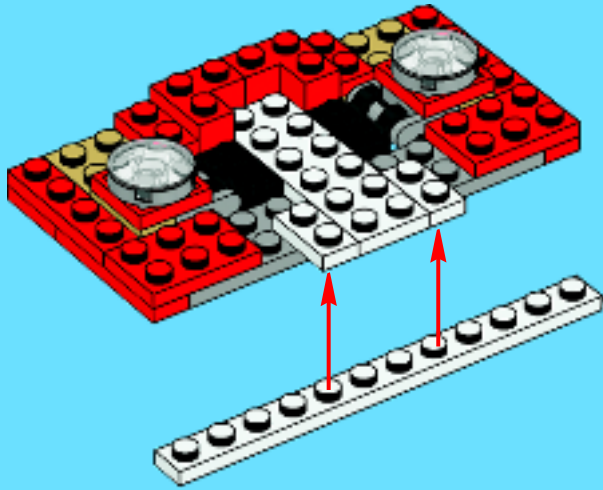

7

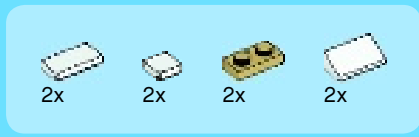
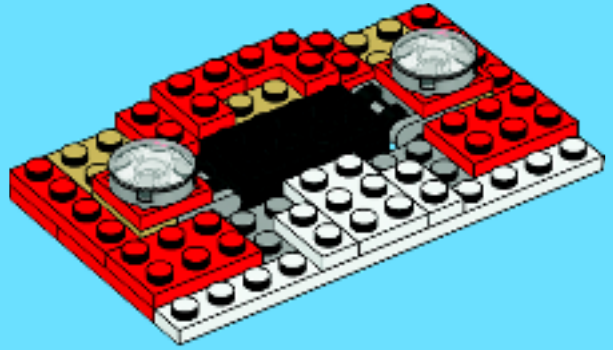

8

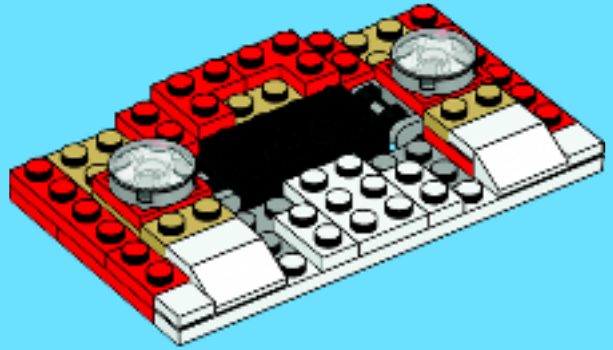



9

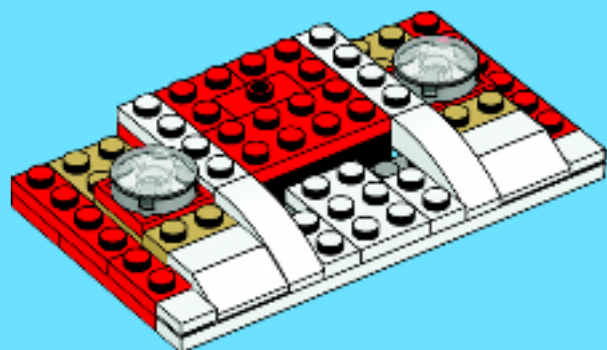

10

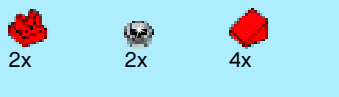
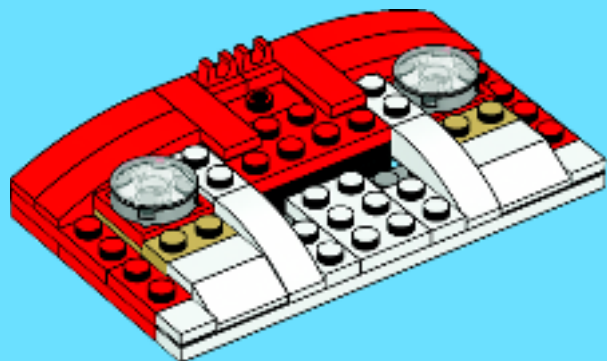

11

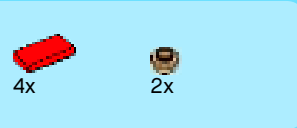
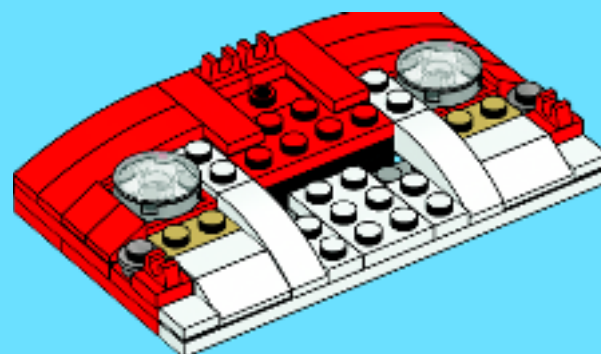

12

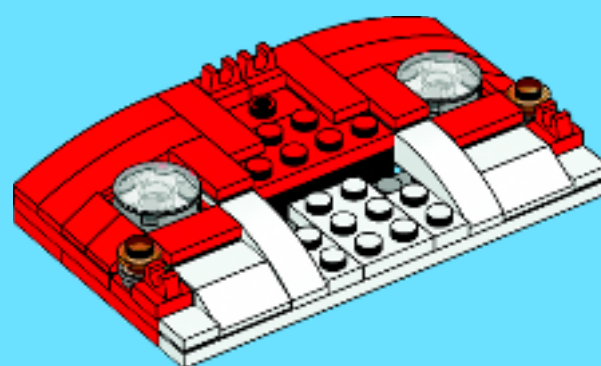



13

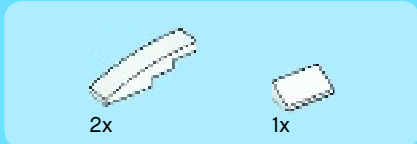
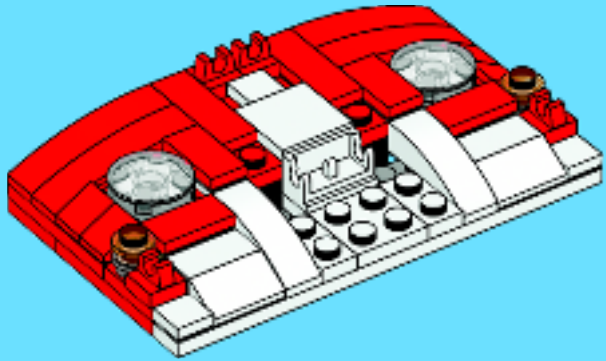

14

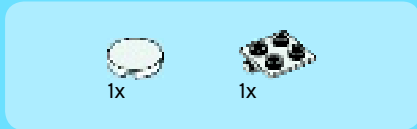
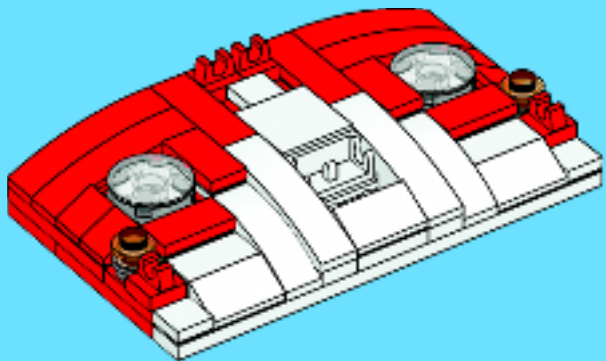

15

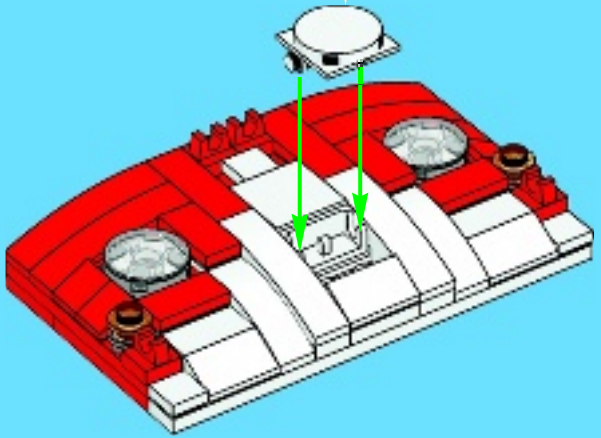
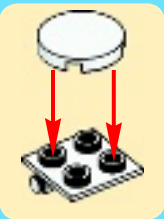

16

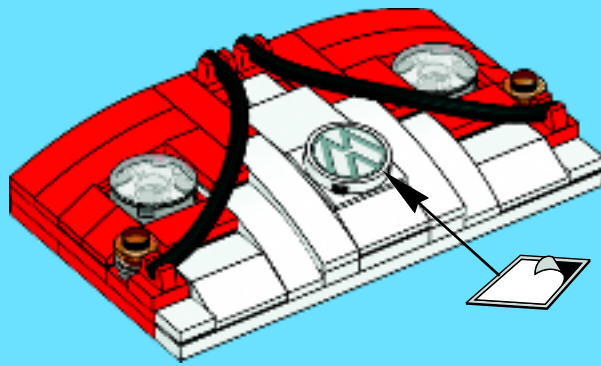

112

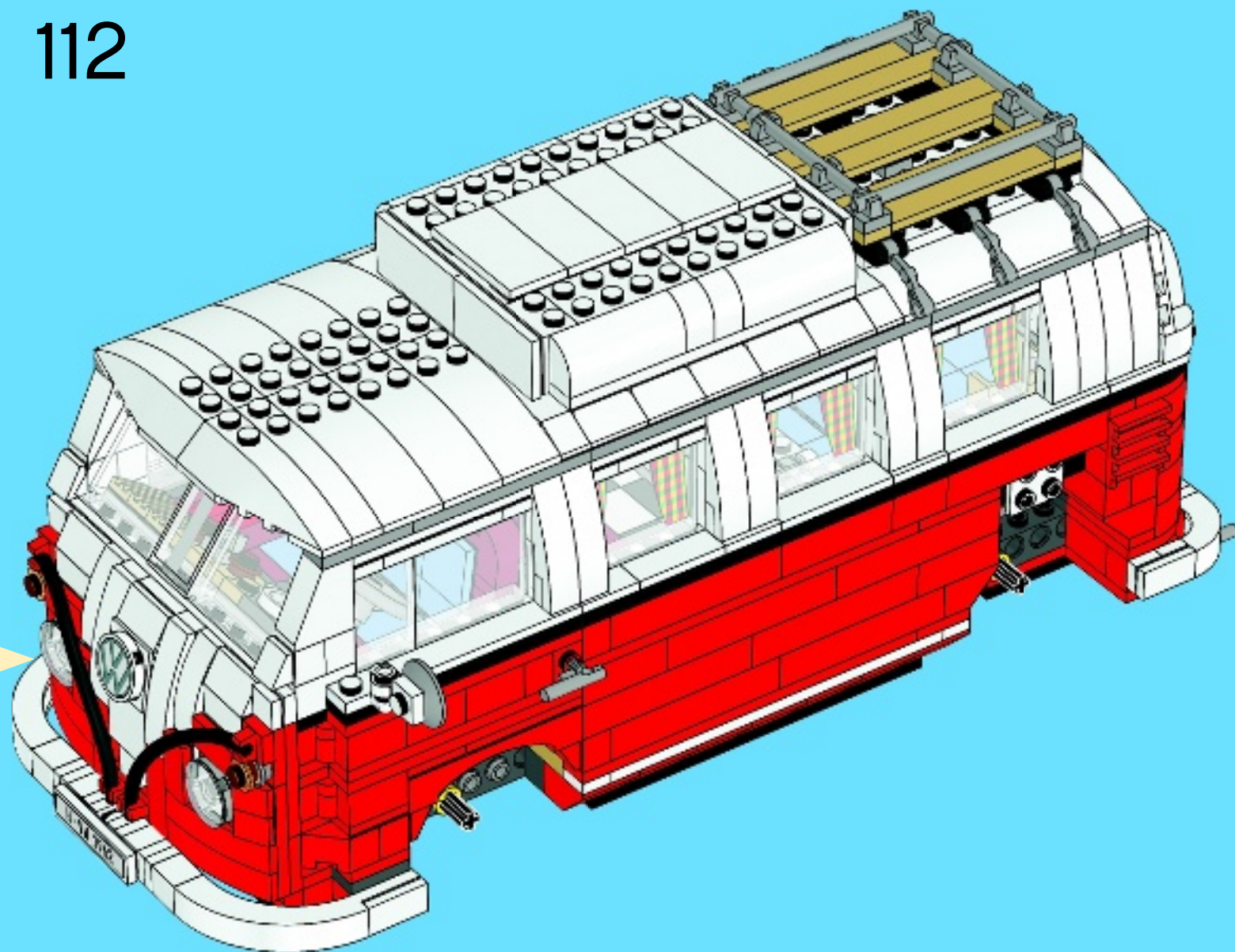

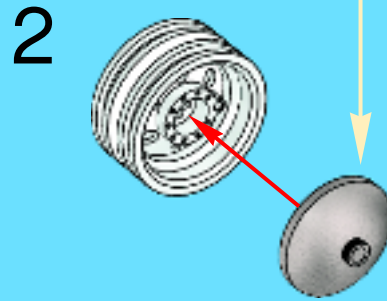
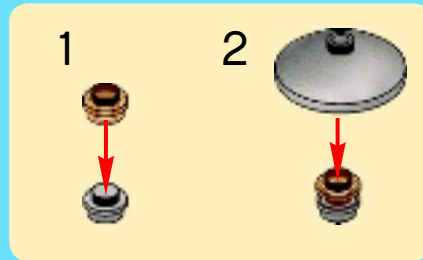

4x

113

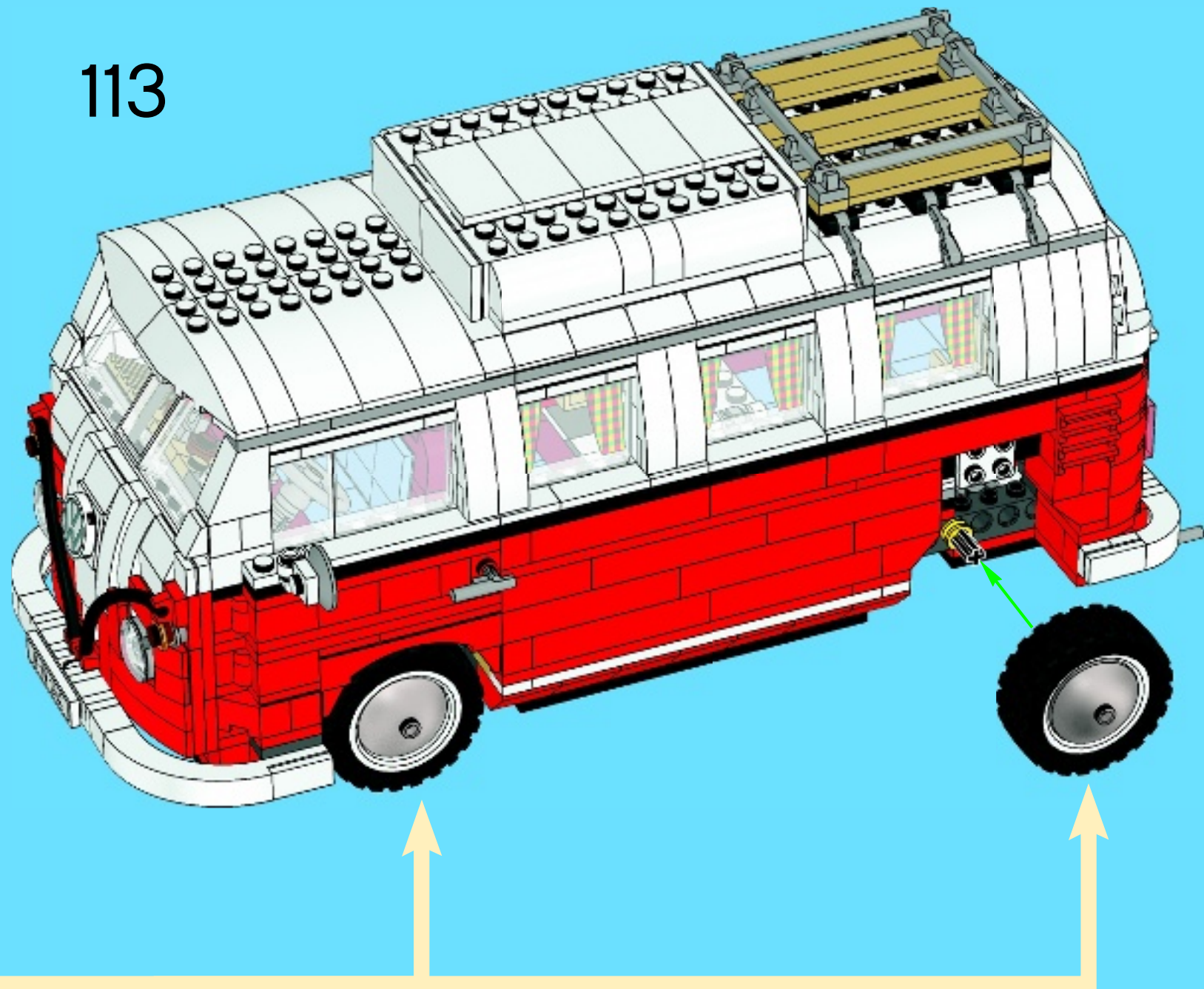



1x

2x

1x

114

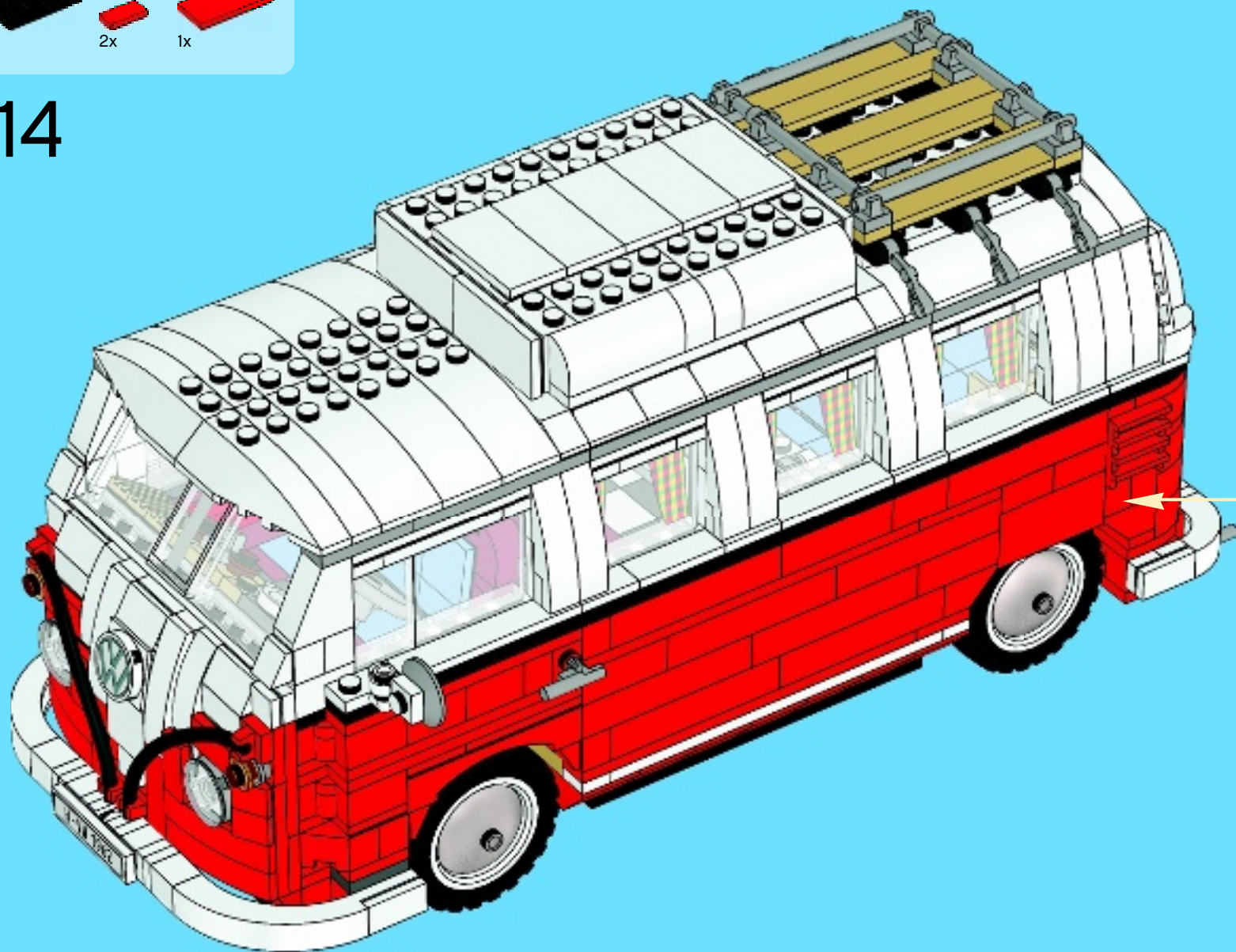

1



2





115

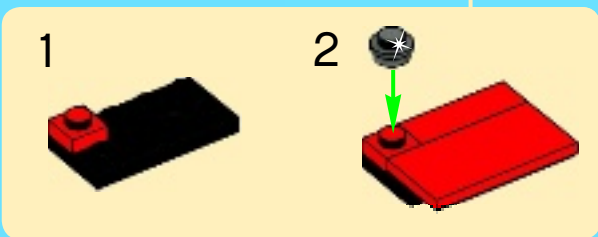
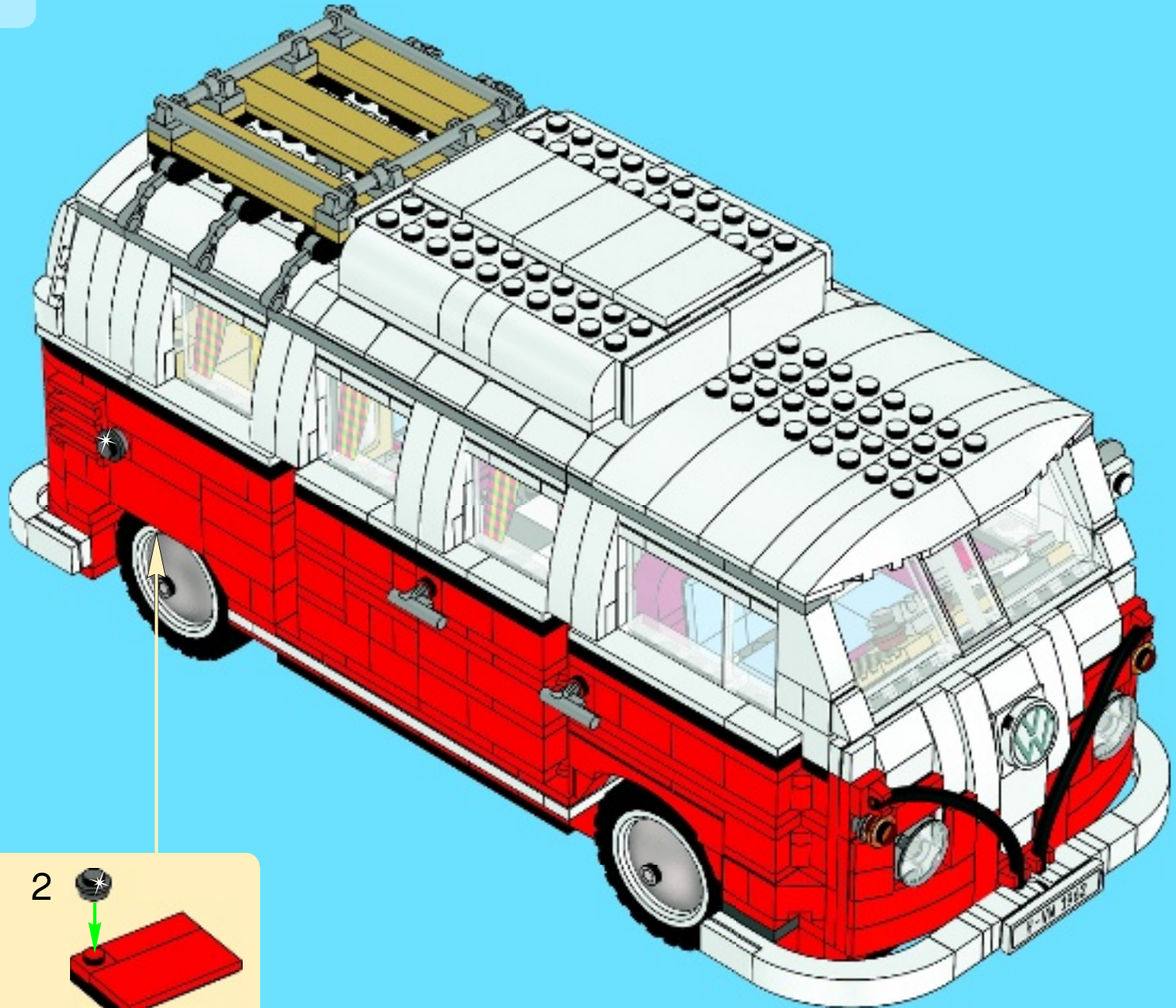

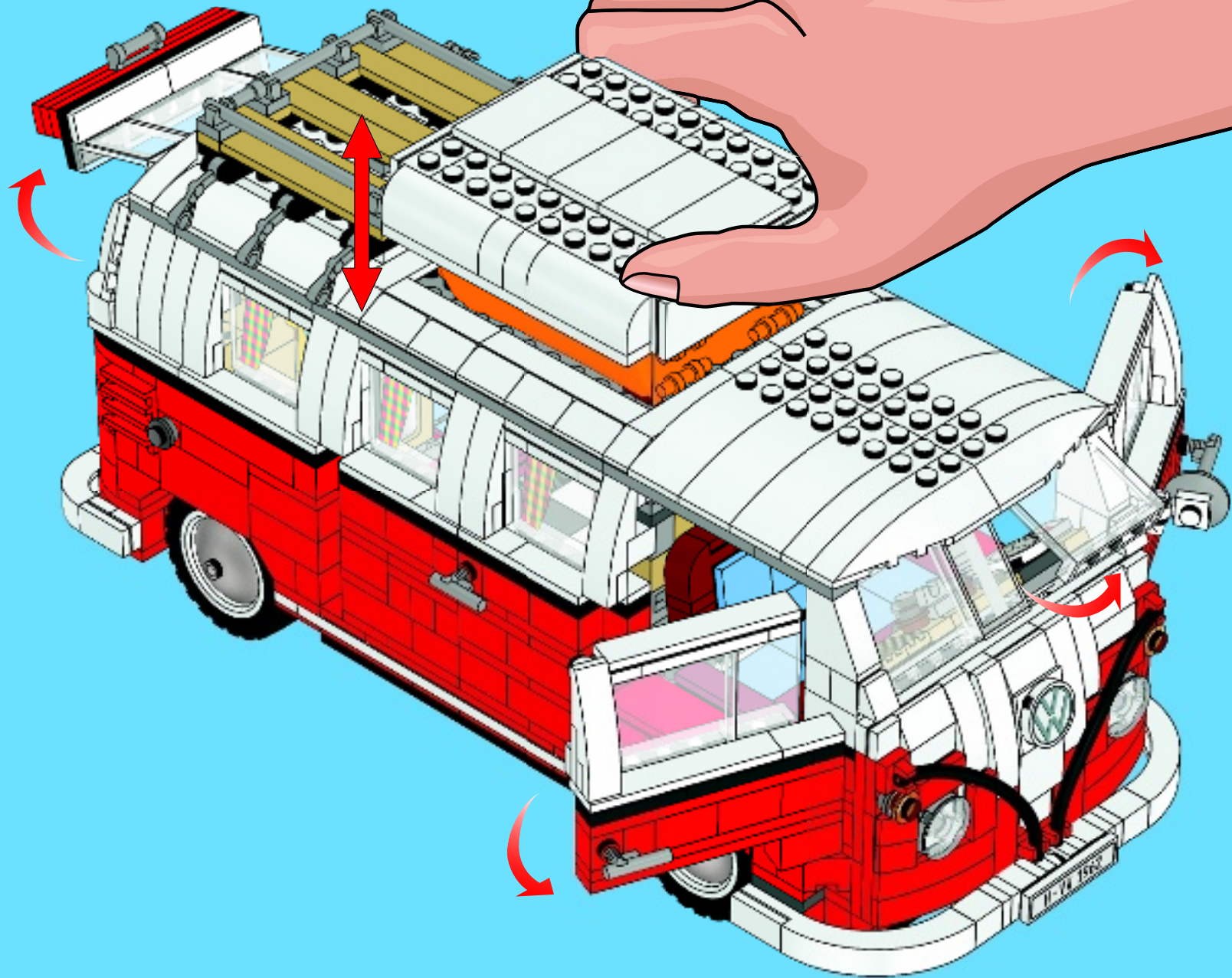

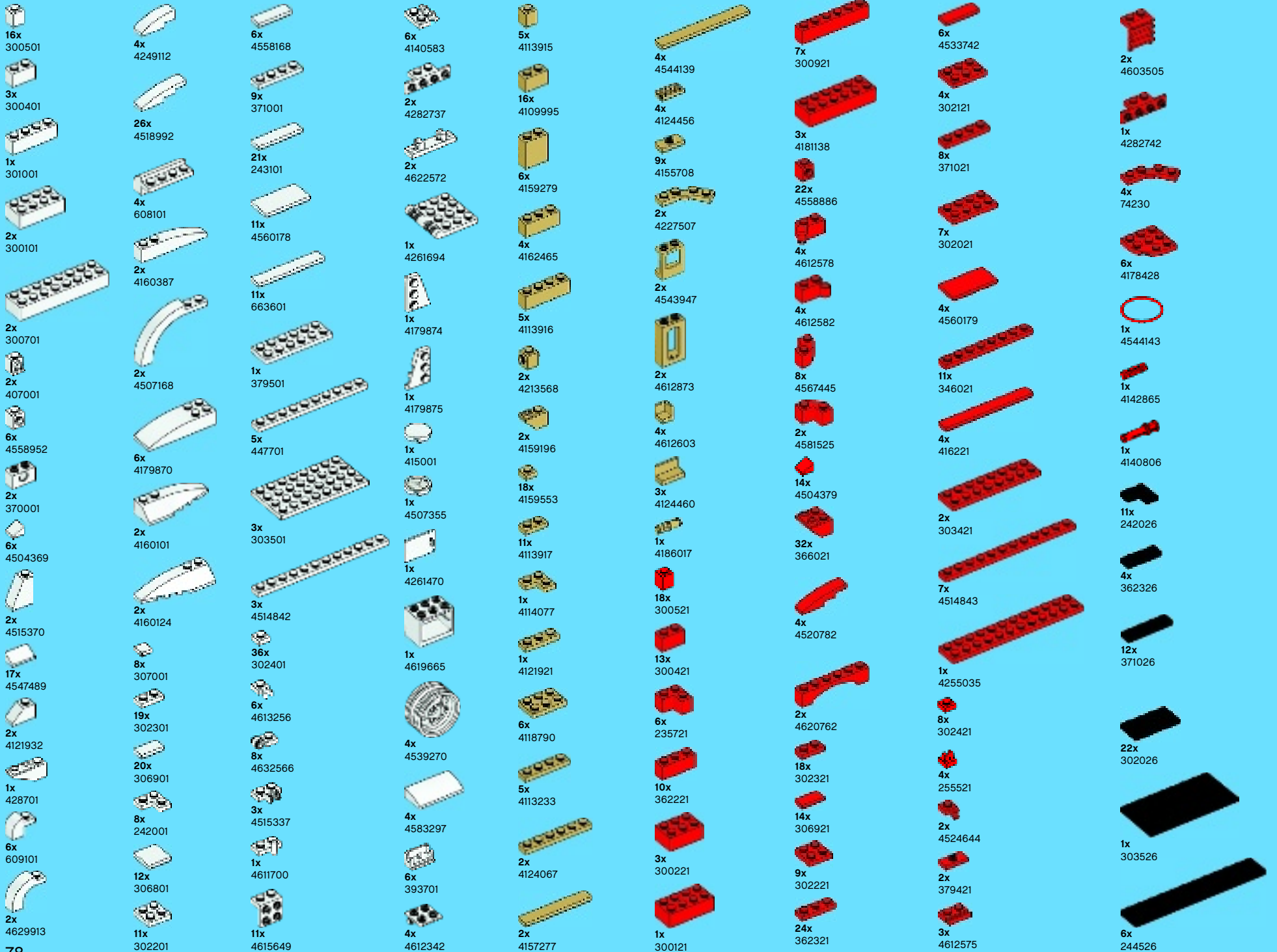

16x 300501
 3x 300401
 1x 301001
 2x 300101
 2x 300701
 2x 407001
 6x 4558952
 2x 370001
 6x 4504369
 2x 4515370
 17x 4547489
 2x 4121932
 1x 428701
 6x 609101
 2x 4629913

4x 4249112
 26x 4518992
 4x 608101
 2x 4160387
 2x 4507168
 6x 4179870
 2x 4160101
 2x 4160124
 8x 307001
 19x 302301
 20x 306901
 8x 242001
 12x 306801
 11x 302201

6x 4558168
 9x 371001
 21x 243101
 11x 4560178
 11x 663601
 1x 379501
 5x 447701
 3x 303501
 3x 4514842
 36x 302401
 6x 4613256
 8x 4632566
 3x 4515337
 1x 4611700
 11x 4615649

6x 4140583
 2x 4282737
 2x 4622572
 1x 4261694
 1x 4179874
 1x 4179875
 1x 415001
 1x 4507355
 1x 4261470
 1x 4619665
 4x 4539270
 4x 4583297
 6x 393701
 4x 4612342

5x 4113915
 16x 4109995
 6x 4159279
 4x 4162465
 5x 4113916
 2x 4213568
 2x 4159196
 18x 4159553
 11x 4113917
 1x 4114077
 1x 4121921
 6x 4118790
 5x 4113233
 2x 4124067
 2x 4157277

4x 4544139
 4x 4124456
 9x 4155708
 2x 4227507
 2x 4543947
 2x 4612873
 4x 4612603
 3x 4124460
 1x 4186017
 18x 300521
 13x 300421
 6x 235721
 10x 362221
 3x 300221
 1x 300121

7x 300921
 3x 4181138
 22x 4558886
 4x 4612578
 4x 4612582
 8x 4567445
 2x 4581525
 14x 4504379
 32x 366021
 4x 4520782
 2x 4620762
 18x 302321
 14x 306921
 9x 302221
 24x 362321

6x 4533742
 4x 302121
 8x 371021
 7x 302021
 4x 4560179
 11x 346021
 4x 416221
 2x 303421
 7x 4514843
 1x 4255035
 8x 302421
 4x 255521
 2x 4524644
 2x 379421
 3x 4612575

2x 4603505
 1x 4282742
 4x 74230
 6x 4178428
 1x 4544143
 1x 4142865
 1x 4140806
 11x 242026
 4x 362326
 12x 371026
 22x 302026
 1x 303526
 6x 244526



Customer Service

Kundenservice

Service Consommateurs

Servicio Al Consumidor

www.lego.com/service or dial



: 00800 5346 5555

: 1-800-422-5346



10219





10214





VIP Program Programme VIP



Earn VIP Points every time you shop directly with us and enjoy valuable rewards

Gagnez des points VIP à chaque achat et profitez de Formidables avantages

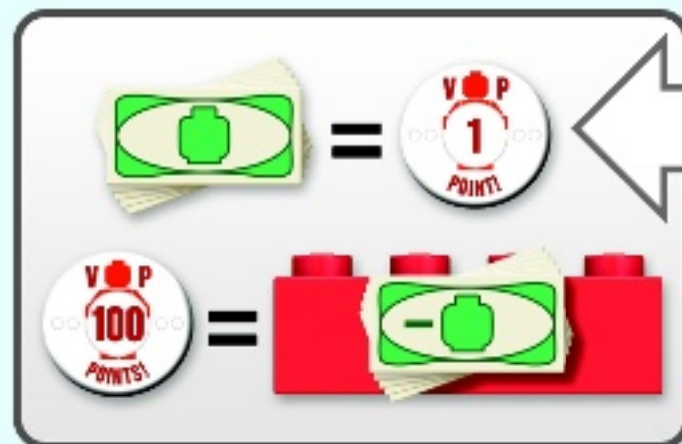

Earn 100 VIP Points and get a reward off your next purchase!

Gagnez 100 points VIP et bénéficiez d'une réduction sur votre prochain achat !



Access exclusive LEGO® sets just for VIPs

Accédez aux ensembles LEGO® exclusifs réservés aux membres VIP



VIP.LEGO.com





www.LEGOclub.com

LEGO club

FREE! GRATIS! GRATUIT!



LEGO Club Magazine



LEGO Club Email



YES! I want to join the LEGO® Club FREE! **OUI!** Je veux m'abonner au LEGO® Club GRATUITEMENT!
Ja! Ich möchte Mitglied im kostenlosen LEGO® Club werden. **Ja!** Ik wil graag GRATIS lid worden van de LEGO® Club.
Ja! Jeg ønsker å melde meg inn i LEGO® Club gratis! **Ja!** Jag vill gå med i LEGO® Club GRATIS!

First name · Prénom
 Vorname · Voornaam
 Fornavn · Förnamn

Last name · Nom de famille
 Name · Achternaam
 Etternavn · Efternamn

Date of Birth · Date de naissance
 Geburtstag · Geboortedatum
 Fødselsdato · Födelsedatum

Street · Adresse
 Straße, Hausnr.
 Straat, huisnr.
 Address

City · Ville
 Ort · Woonplaats
 Poststed · Postort

Zip/Postcode · Code
 Postal · PLZ · Postcode · Postnummer

Email · Courriel · E-Mail · E-post

- Fill in your email address and we will send you a membership confirmation and monthly email newsletters. If you do not wish to receive the newsletters please tick here. Remplis ton adresse e-mail et nous t'enverrons une confirmation d'adhésion ainsi que le bulletin e-mail mensuel. Si tu ne désires pas recevoir le bulletin, coche cette case. Vul je e-mailadres in en we sturen je een bevestiging van je lidmaatschap en maandelijke e-mail nieuwsbrieven. Als je geen e-mail wilt ontvangen, kruis dan dit vakje aan.
- Ich möchte per E-Mail den monatlichen LEGO Club Newsletter erhalten. Ønsker du at vi skal sende en liten hilsen til barnet ditt for å bekrefte medlemskapet, ber vi deg krysse av i feltet, samt oppgi e-postadressen som hilsenen skal sendes til. Om du vill att vi ska skicka en bekräftelse på ditt barns medlemskap, ber vi dig sätta ett kryss i rutan och skriva den e-post adress som bekräftelsen ska skickas till.
- If you do not wish to receive additional mailings from the LEGO Club please tick here. Si tu ne désires pas recevoir de courrier supplémentaire du Club LEGO, coche cette case. Als je geen verdere post van de LEGO Club wilt ontvangen, kruis dan dit vakje aan.
- Dersom du ønsker å motta annen informasjon fra LEGO Gruppen, setter du et kryss her.

<p>Mail to: / Poster à: LEGO® Club P.O. Box 1157 Enfield, CT USA 06083-1157</p>	<p>Per Post an: LEGO® Club Postfach 14 15 D-36243 Niederaula</p>	<p>Send til: LEGO® Club Norge Postboks 58 1314 Vøyenenga</p>
<p>Mail to: LEGO® Club 33 Bath Road Slough SL1 3UF United Kingdom</p>	<p>Stuur op naar: LEGO® Club Postbus 40250 3504 AB Utrecht</p>	<p>Skickas till: LEGO® Club Sverige Ubox 841 202 29 Malmö</p>
<p>Poster à: LEGO® Club 21 rue de la banque 75 002 PARIS FRANCE</p>		

The English language version of the magazine can only be mailed to addresses in the US, Canada, the UK, and Republic of Ireland. Club membership is valid for two years and includes free copies of the LEGO Club Magazine and e-mail newsletters. In the US and Canada please allow up to 6 weeks for delivery of your first magazine. In the UK and Republic of Ireland please allow six to 14 weeks for delivery of your first magazine. By signing this form you consent the LEGO Club to use your child's data for LEGO mailings. The data will only be used for LEGO mailings and will not be sold, rented or otherwise disclosed to any company outside the LEGO Group except for disclosure to companies acting as our agents to help us provide services requested by the child. This coupon is valid for one free membership per person, group or organization. Photocopied coupons are accepted. La version française du magazine peut être postée uniquement au Canada. L'abonnement est valide pour 2 ans et inclut des exemplaires gratuits du Magazine LEGO. Aux É.-U. et au Canada, allouer 6 semaines pour la livraison initiale. En remplissant ce formulaire, vous consentez à ce que LEGO utilise les informations de votre enfant pour des envois postaux de LEGO. L'information sera utilisée uniquement pour des envois postaux par LEGO et ne sera en aucun cas, vendue, louée, échangée ou divulguée à d'autres compagnies autres que la compagnie LEGO, à l'exception des compagnies affiliées qui nous procurent des services auxquels l'enfant en a fait la demande. Formulaire photocopie accepté. Mit der folgenden Unterschrift erkläre ich, für mein Kind den Beitritt als Mitglied zum kostenlosen LEGO Club, der von der LEGO GmbH, D-85627 Grasbrunn, betrieben wird. Die Mitgliedschaft beinhaltet die Zusendung des LEGO Club Magazines und kann beiderseits jederzeit beendet werden. Mit der Mitgliedschaft im LEGO Club sind keinerlei Verpflichtungen verbunden. Das deutschsprachige LEGO Club Magazine wird nur an Adressen in Deutschland, Österreich und der Schweiz versendet. Eine Anmeldebestätigung kann nur per E-Mail geschickt werden. Das Magazin erscheint fünfmal jährlich. Daher kann die Zustellung des ersten Heftes bis zu drei Monate dauern. Die Mitgliedschaft ist beidseitig jederzeit kündbar, ohne dass Ihnen Kosten entstehen. Sie können der werblichen Nutzung Ihrer Daten jederzeit widersprechen. Kündigung und Widerspruch können Sie telefonisch erklären (00800 / 5346 5555, Anruf gebührenfrei, Kosten für Anrufe aus dem Mobilfunknetz können abweichen) oder an die LEGO GmbH senden. Het Nederlandse LEGO Club Magazine kan alleen worden gestuurd naar adressen in Nederland. Het lidmaatschap is 2 jaar geldig en geeft recht op toezending van het gratis LEGO Club Magazine en LEGO Club e-mails. Het eerste magazine zal binnen 12 tot 14 weken toegestuurd worden. Het lidmaatschap kan op ieder moment opgezegd worden en kan na 2 jaar gratis worden verlengd, tenzij LEGO met deze activiteit stopt. Uw gegevens worden uitsluitend gebruikt voor mailings van LEGO en zullen niet worden verkocht, verhuurd of op welke wijze dan ook verspreid aan derden buiten de LEGO Group, uitgezonderd de organisaties die namens ons optreden om de informatie te sturen waarvoor toestemming is verleend. Den svenska versionen av tidningen kan endast skickas till adresser i Sverige. Club-medlemskap är giltigt i 2 år och innefattar gratis exemplar av LEGO Club Magazine. Vänligen räkna med minimum 6 veckor för leverans av din första tidning. Genom att skicka in det här formuläret godkänner du att LEGO Club använder barnets uppgifter för LEGO utskick. Uppgifterna kommer bara att användas för LEGO utskick och kommer inte att säljas, hyras ut eller vidarebefordras till något företag som inte tillhör LEGO Gruppen, med undantag av företag som agerar som våra ombud för att tillhandahålla tjänster som barnet har begärt. Den här kupongen gäller för ett gratis medlemskap per person, grupp eller organisation. En complément ce bulletin d'adhésion, vous acceptez que LEGO Club utilise les données relatives à votre enfant pour l'envoi de courriers concernant LEGO. Ces données seront uniquement utilisées pour l'envoi d'information concernant LEGO et ne seront ni vendues, ni louées ni utilisées par d'autres sociétés que le groupe LEGO, à l'exception des sociétés agissant pour le compte de LEGO en tant que sous-traitant de services divers. L'abonnement au LEGO Club est valable pour une période de 2 ans. Il inclut l'envoi par courrier du magazine LEGO Club et par email de newsletters. Un délai de 6 à 14 semaines est à prévoir pour la réception de votre premier magazine. Ce bulletin d'adhésion gratuit est valable pour l'inscription d'une seule personne. Les photocopies sont acceptées. ATTENTION! Le bulletin d'adhésion doit être rempli et signé par un parent ou un tuteur.

VISIT THE WORLD'S BIGGEST LEGO SHOP
 www.LEGOshop.com
 0376
 www.LEGOclub.com

00800 5346 5555
 1-866-534-6258 • 1-877-518-5346

* Freephone. Mobile charges may apply. * Numéro sans frais. Des frais peuvent s'appliquer avec les téléphones cellulaires. * Gebührenfrei, Kosten für Anrufe aus Mobilfunknetzen können abweichen. * Gratis telefonnummer vanaf vaste lijn. * Det er et gratis nummer, når du ringer fra fasttelefon. * Det är gratis, när du ringer från en fast telefon. * Numéro sans frais. Des frais peuvent s'appliquer avec les téléphones portables.

Parent's signature · Signature d'un parent ou d'un tuteur
 Unterschrift Erziehungsberechtigter/ · Handtekening ouders
 Foreldres/foresattes underskrift · Förälders /förmyndares underskrift

Date
 Datum
 Date



WIN!

Go to www.LEGOsurvey.com/product to fill out a survey for a chance to win a cool LEGO® Product. No purchase necessary. Open to all residents where not prohibited.

 www.LEGO.com



www.LEGOsurvey.com/product

GEWINNE!

Nimm an der Umfrage auf www.LEGOsurvey.com/product teil und hab die Chance ein cooles LEGO® Produkt zu gewinnen! Die Teilnahme am Gewinnspiel führt zu keinerlei Kaufverpflichtungen. Teilnahme in allen nicht ausgeschlossenen Ländern möglich.

WIN!

Ga naar www.LEGOsurvey.com/product, vul een enquêteformulier in en maak kans op een cool LEGO® product. Geen aankoopverplichting. Iedereen mag deelnemen, uitzonderd ingezetenden van landen waar een enquêteverbod geldt.

GAGNE!

Visite www.LEGOsurvey.com/product pour répondre à un questionnaire et avoir une chance de gagner un produit LEGO® très cool ! Aucune obligation d'achat. Ouvert à tous les résidents des pays autorisés.

当てよう!

www.LEGOsurvey.com/product にアクセスして、アンケートにご記入ください。当選者にはレゴ®製品を差し上げます。お買い上げの必要はありません。禁止されていない限り、すべての皆様にご利用いただけます。

LEGO and the LEGO logo are trademarks of the/sonst des marques de commerce de/son marcas registradas de LEGO Group. ©2011 The LEGO Group. Trademarks, design patents and copyrights are used with the approval of the owner Volkswagen AG./ Les marques déposées, les brevets de conception et les copyrights sont utilisés avec l'autorisation du propriétaire Volkswagen AG./ El uso de las marcas comerciales, patentes de diseño y derechos de autor se realiza con el consentimiento de su propietario, Volkswagen AG.