

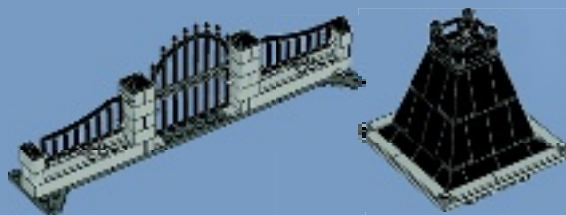

# MONSTER FIGHTERS

10228

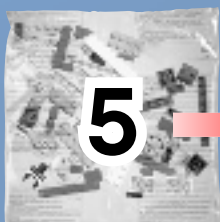

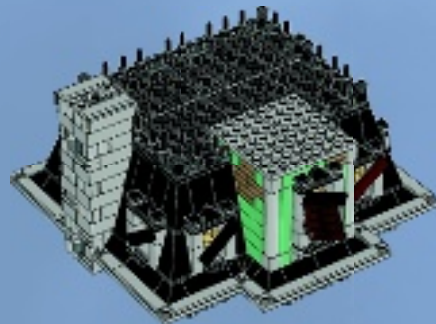
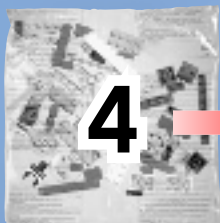
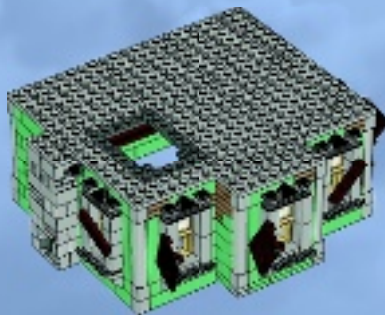
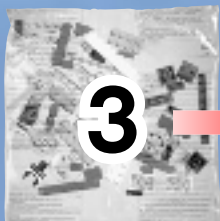
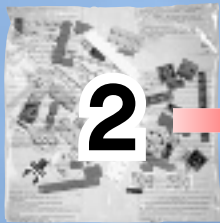
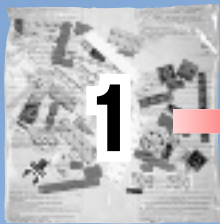



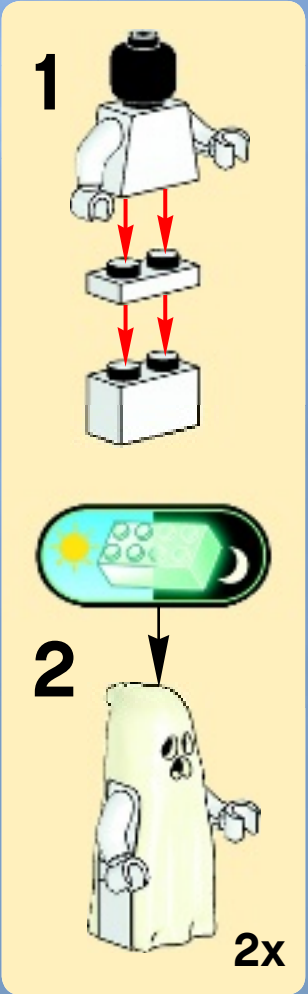
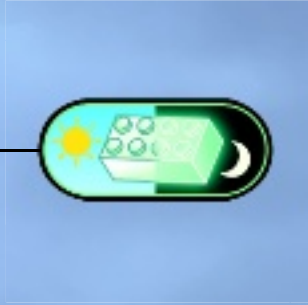
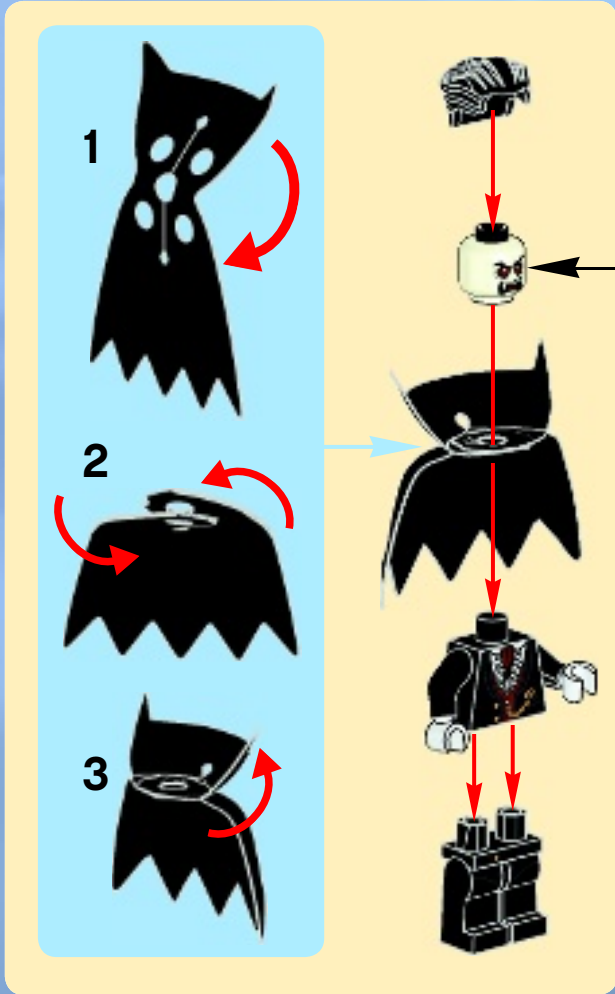

<http://lego.com/brickseparator>

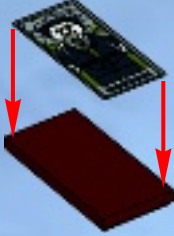
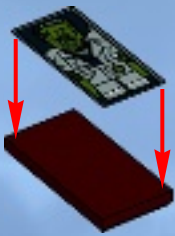
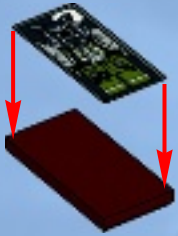
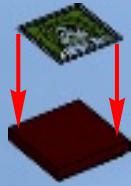
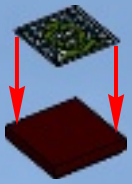

2

1



2



3

1



2



2x



1



4

1



2







# 5

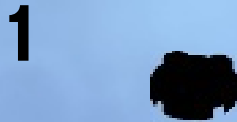

# 6





# 7

1



2



3



4



# 8

1

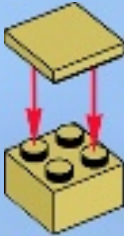

2

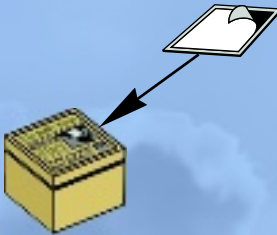

3



4

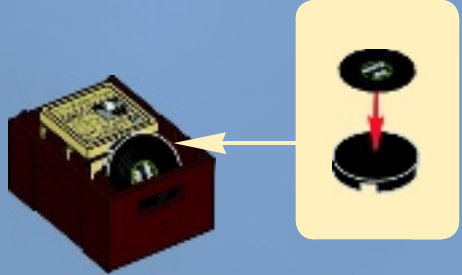





# 9



# 10

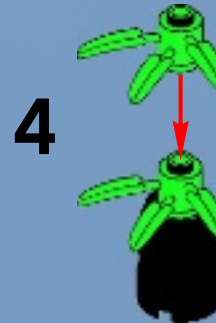
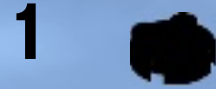



1x



1x

# 11

1

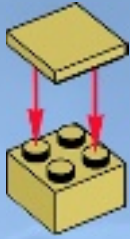

2

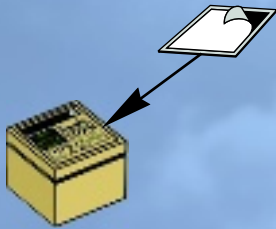

1x



1x



1x

# 12

1



2



2x



1x

# 13

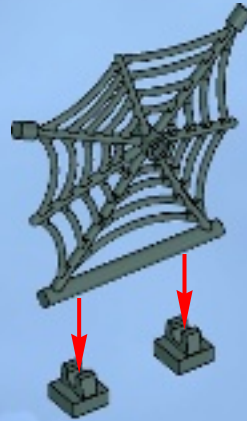

1x



1x



1x

# 14

1

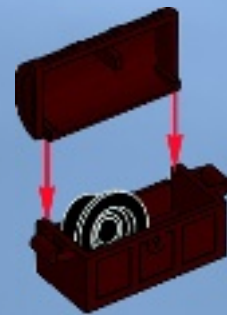

2





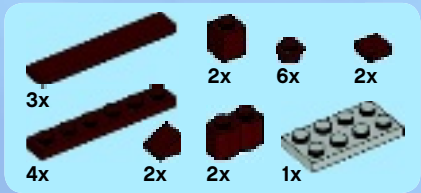

15

1



2



3

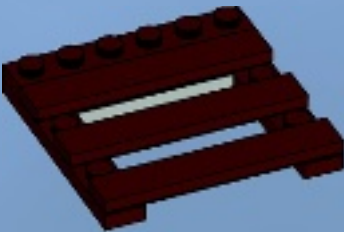

4

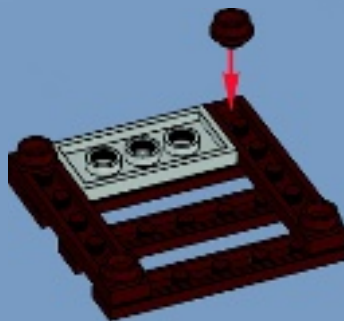

5

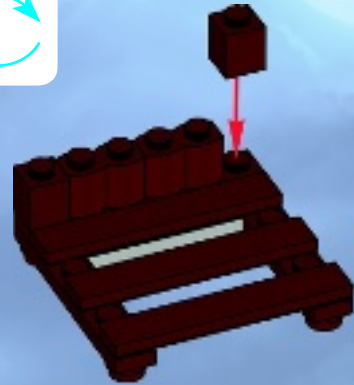

6



7



8



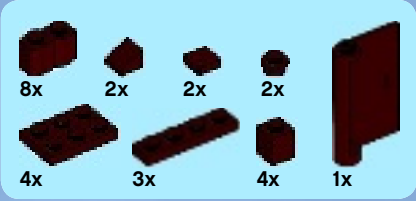

# 16

1



2

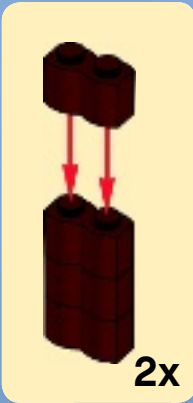

3

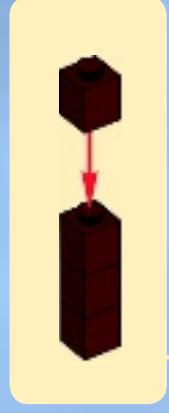
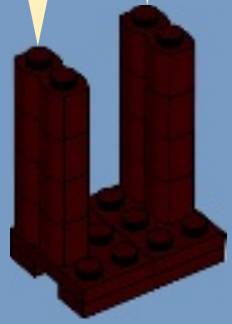

4

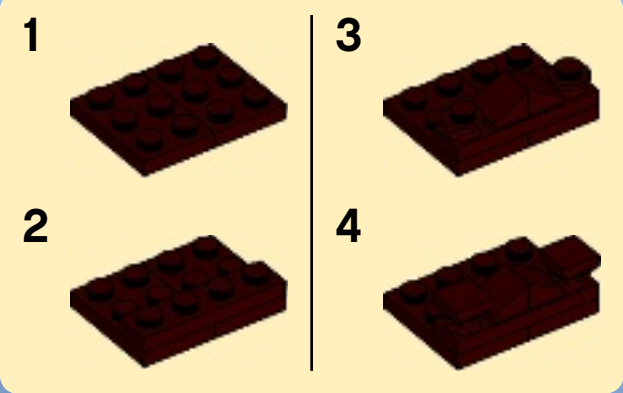
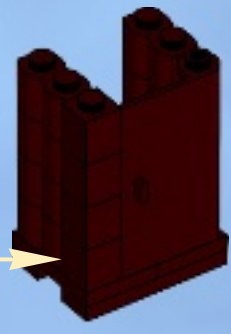

5

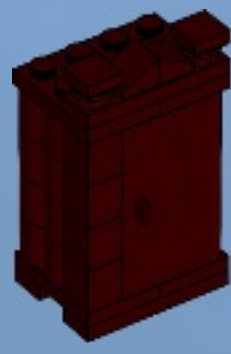





1x



1x



2x



2x



1x



1x



1x



3x



2x



2x



1x



1x

# 17

1

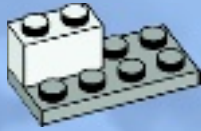

2

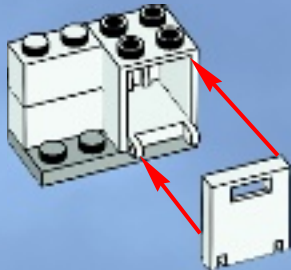

3



4



5



6



7



8



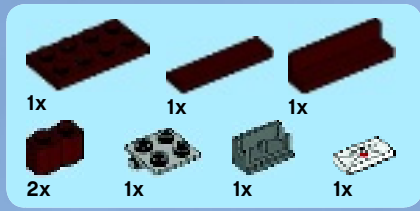

# 18

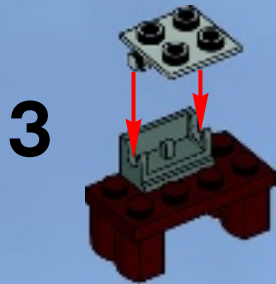

# 19



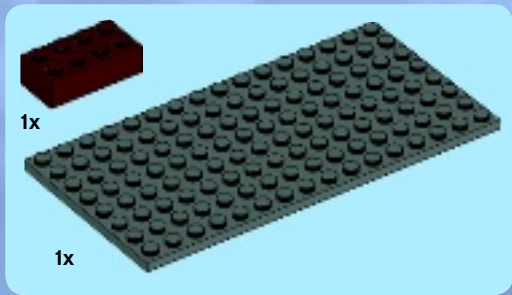
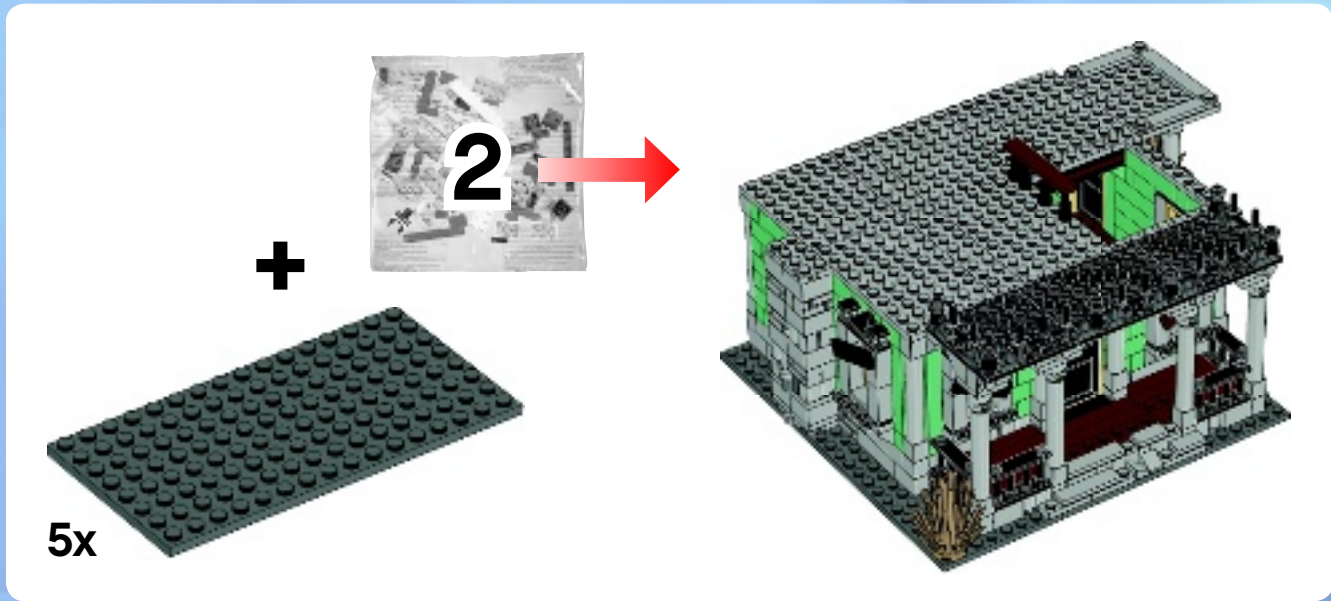

1

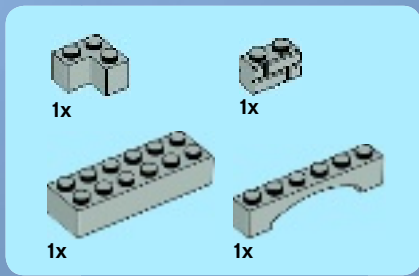
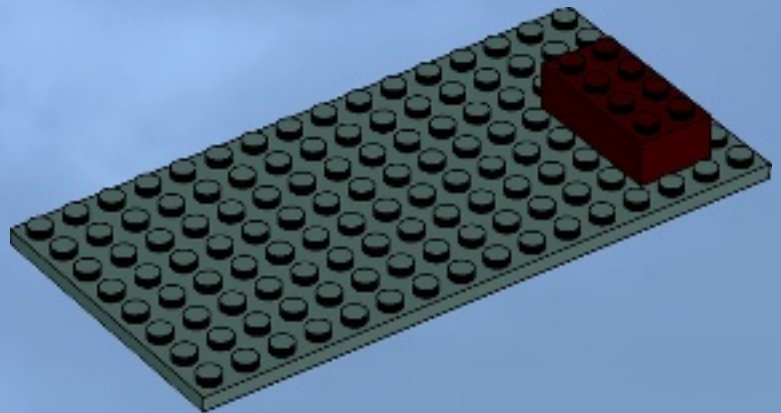

2

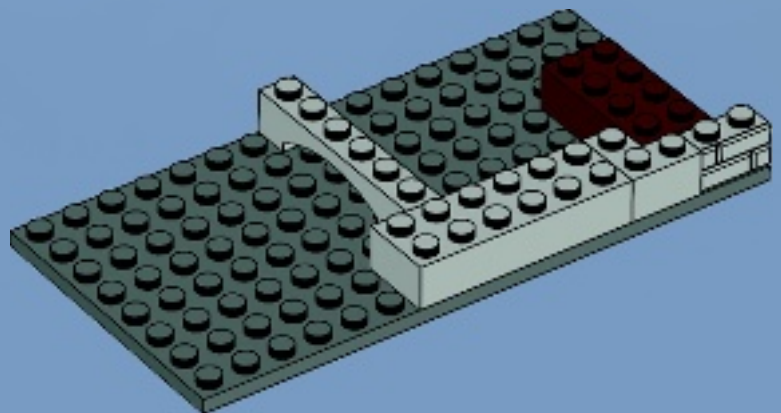



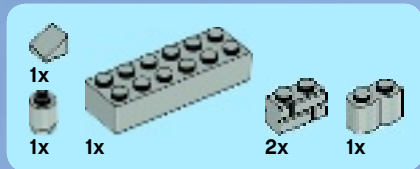

3

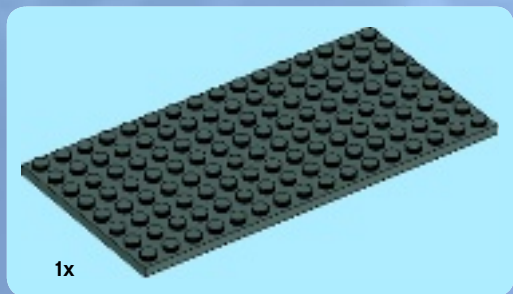
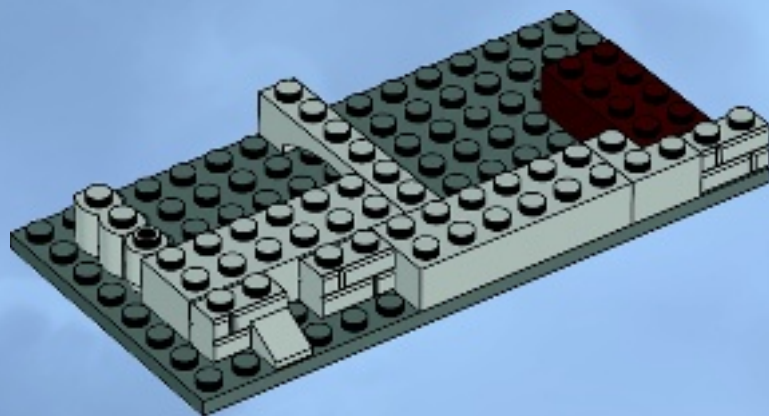

4

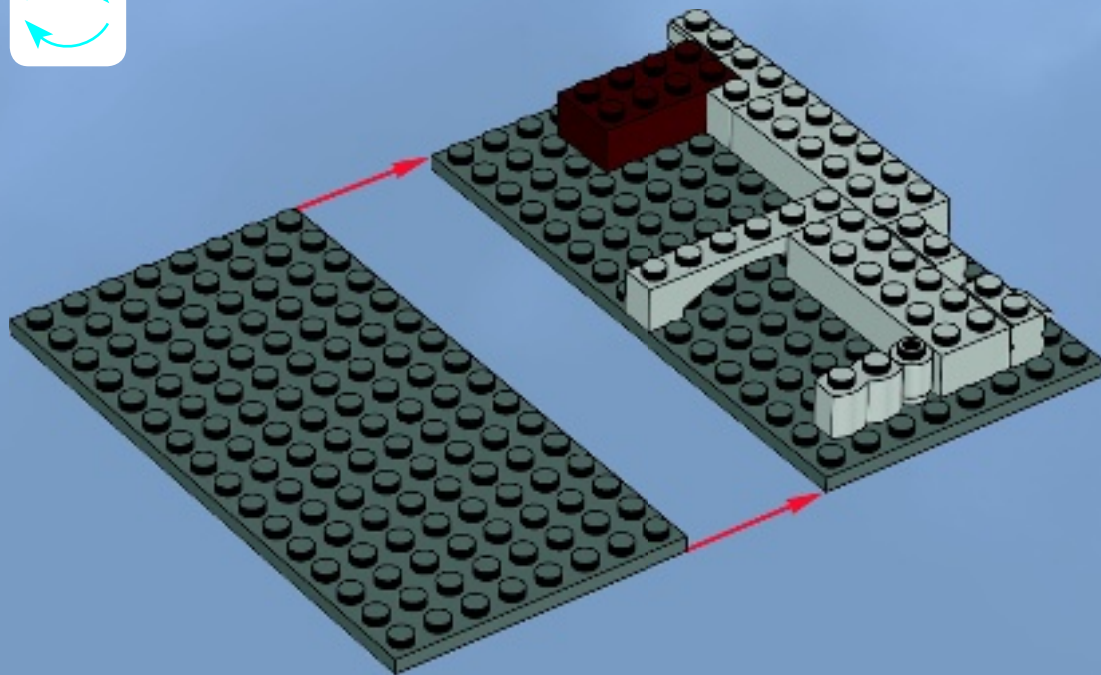





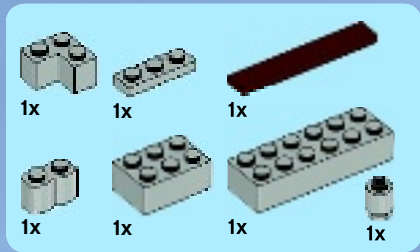

7

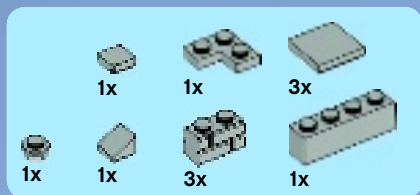
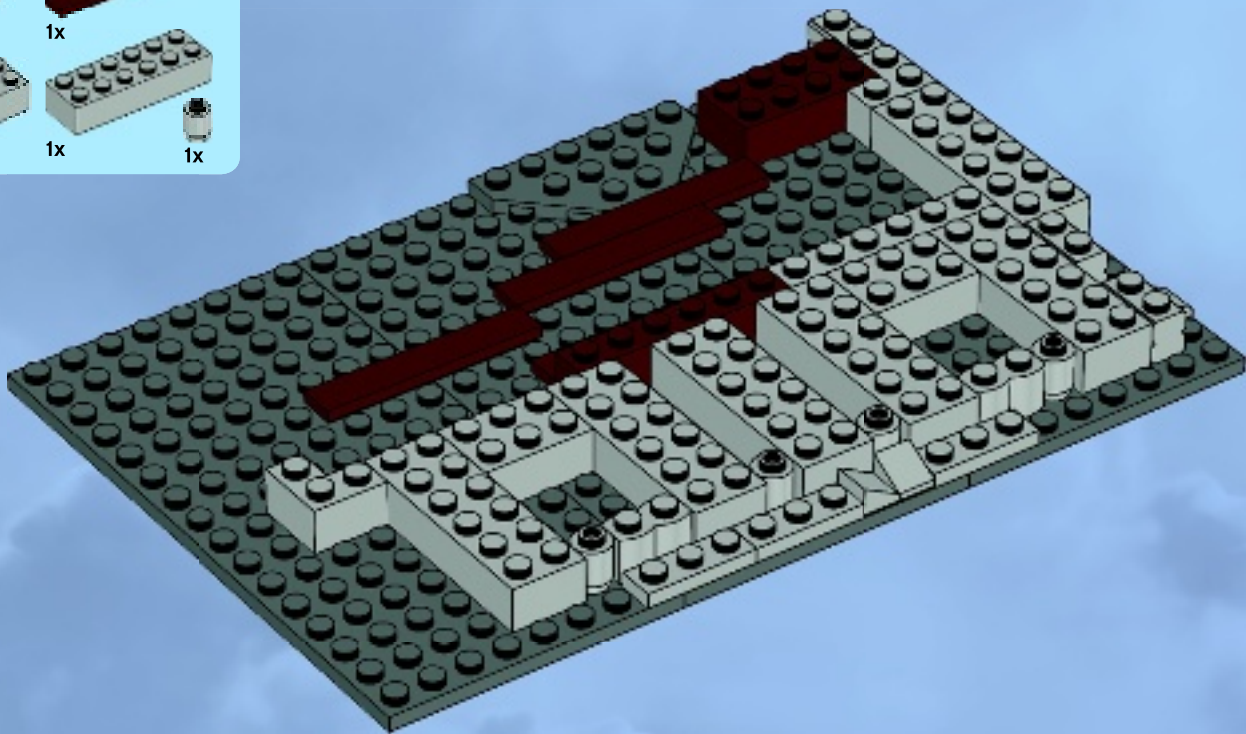

8

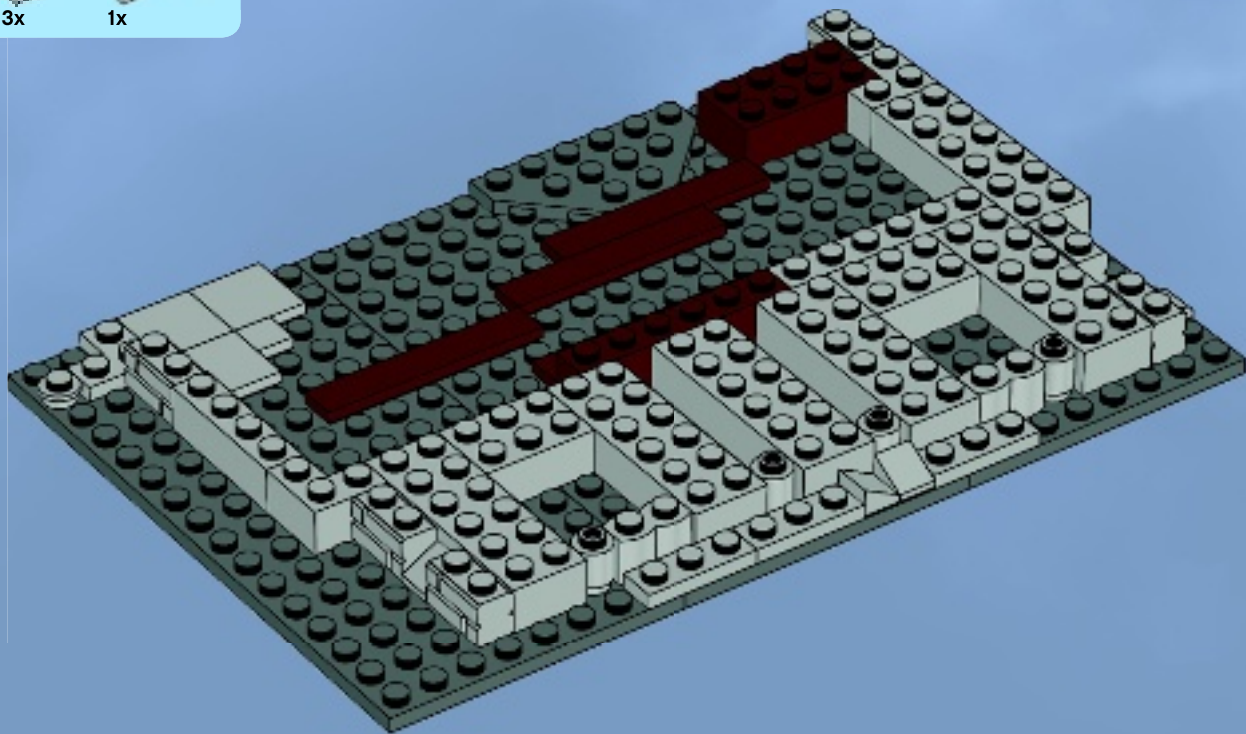







1x



1x



1x



3x

# 10

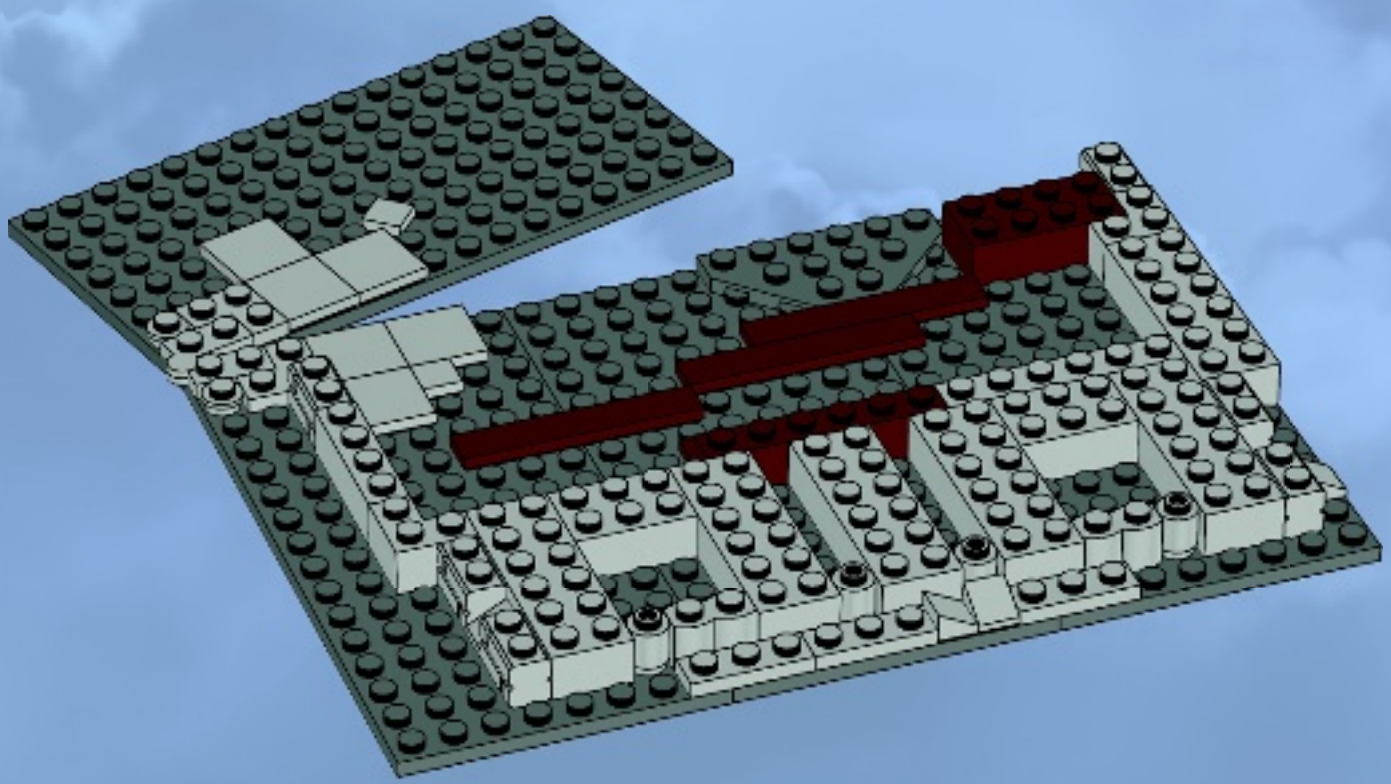



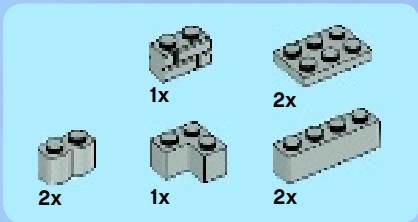

# 11

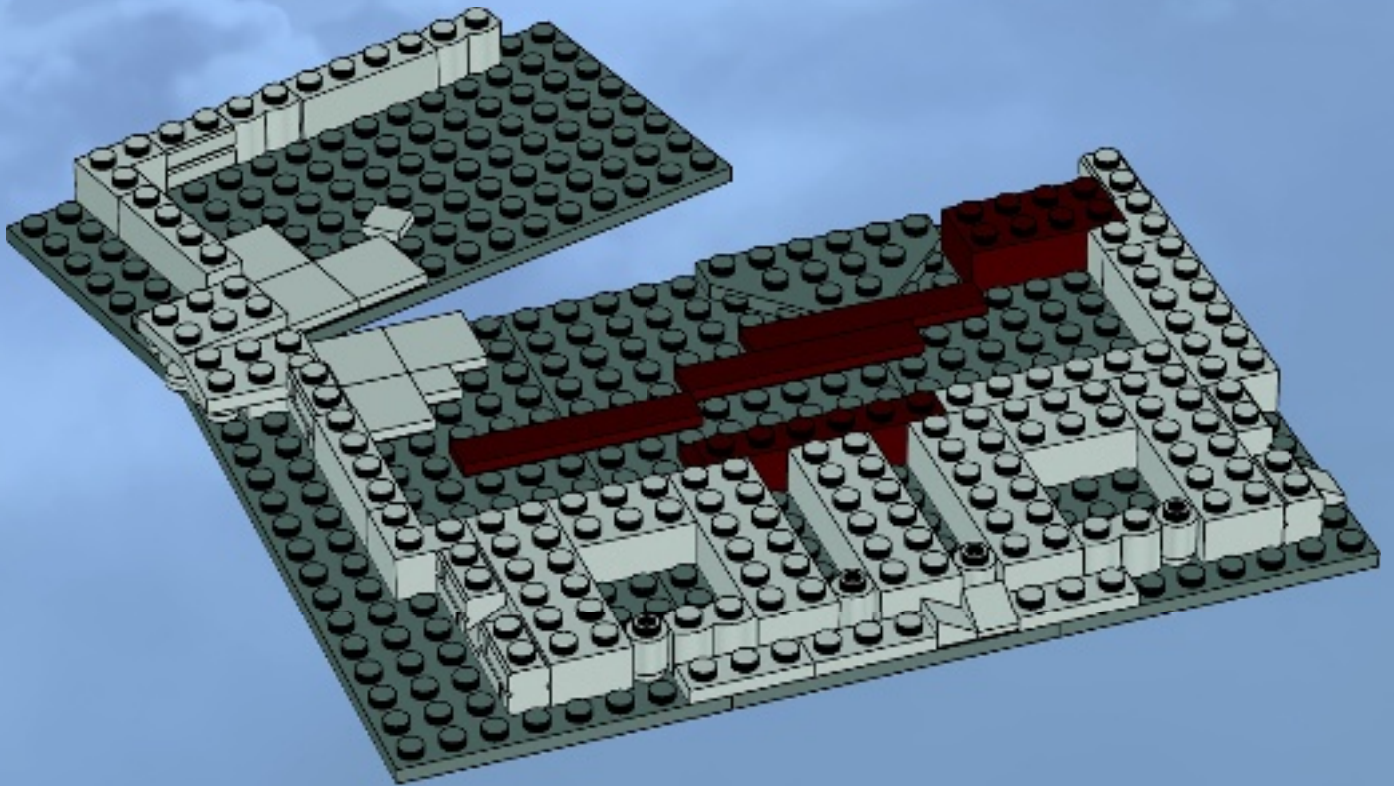

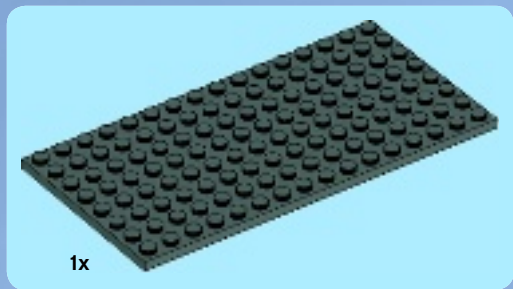

12

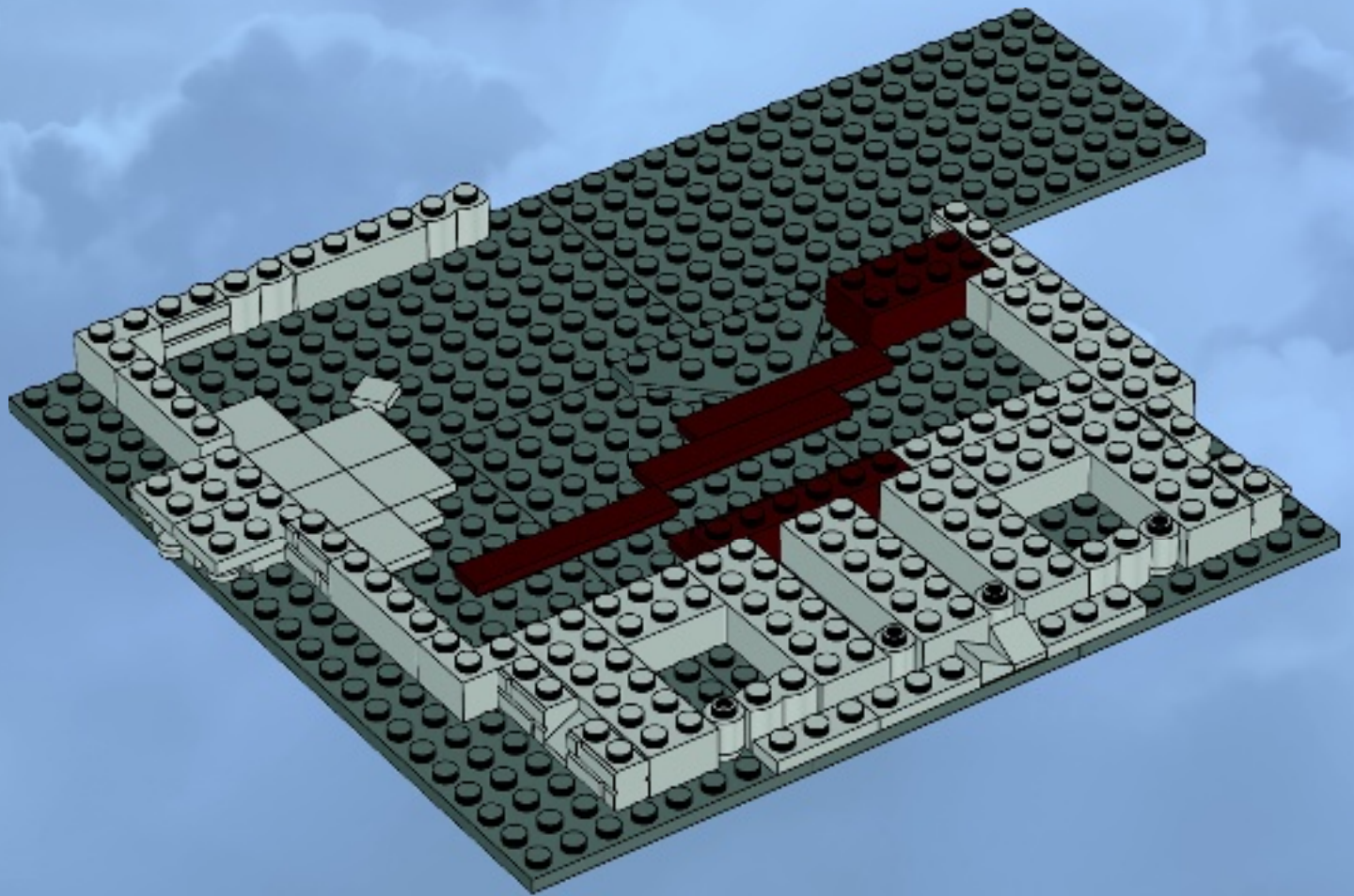

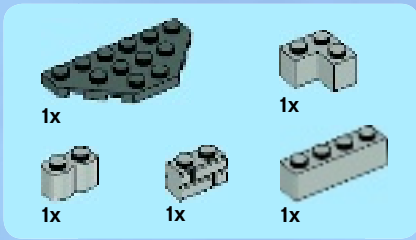

# 13

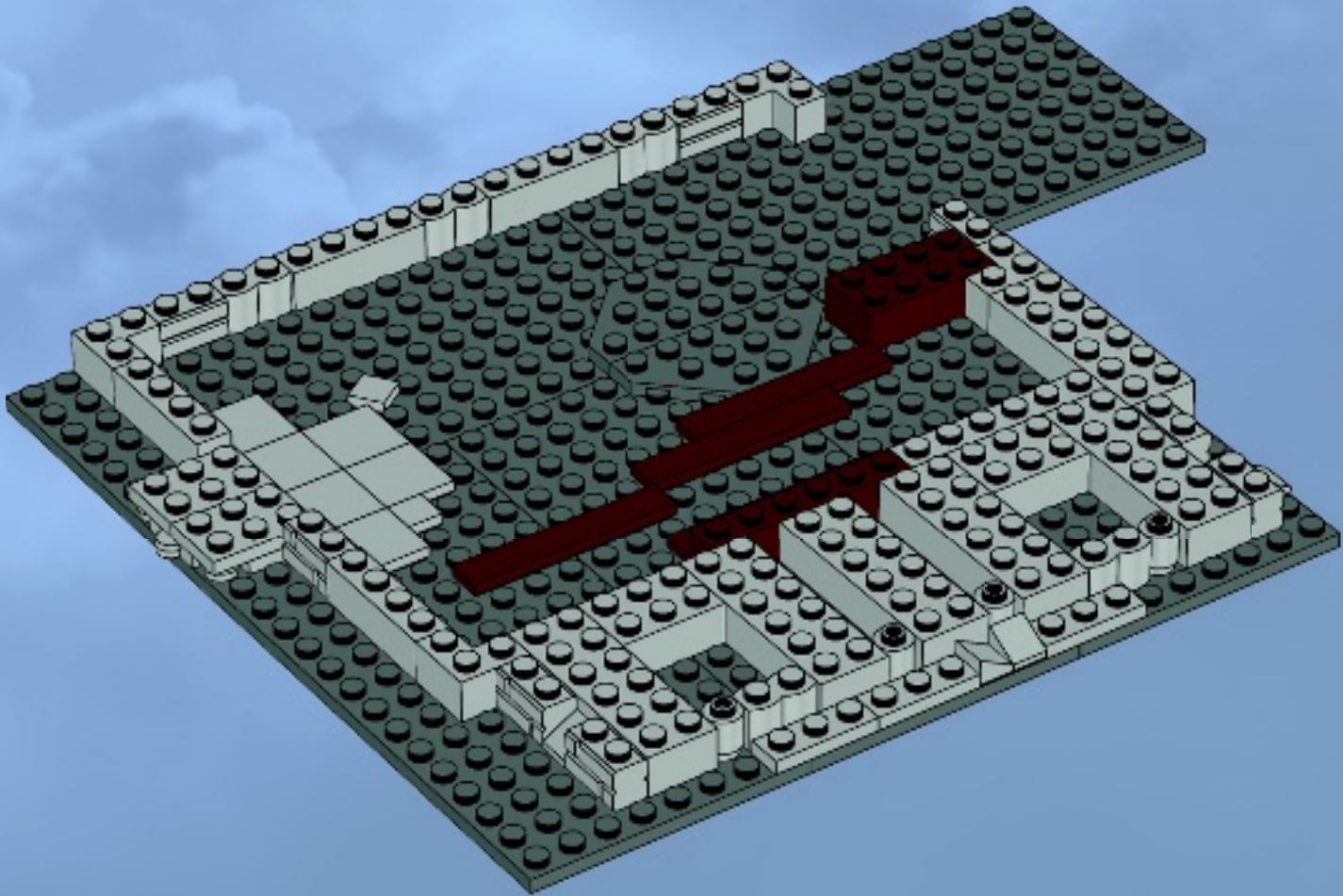



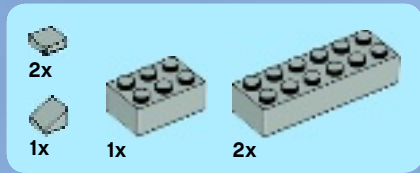

14

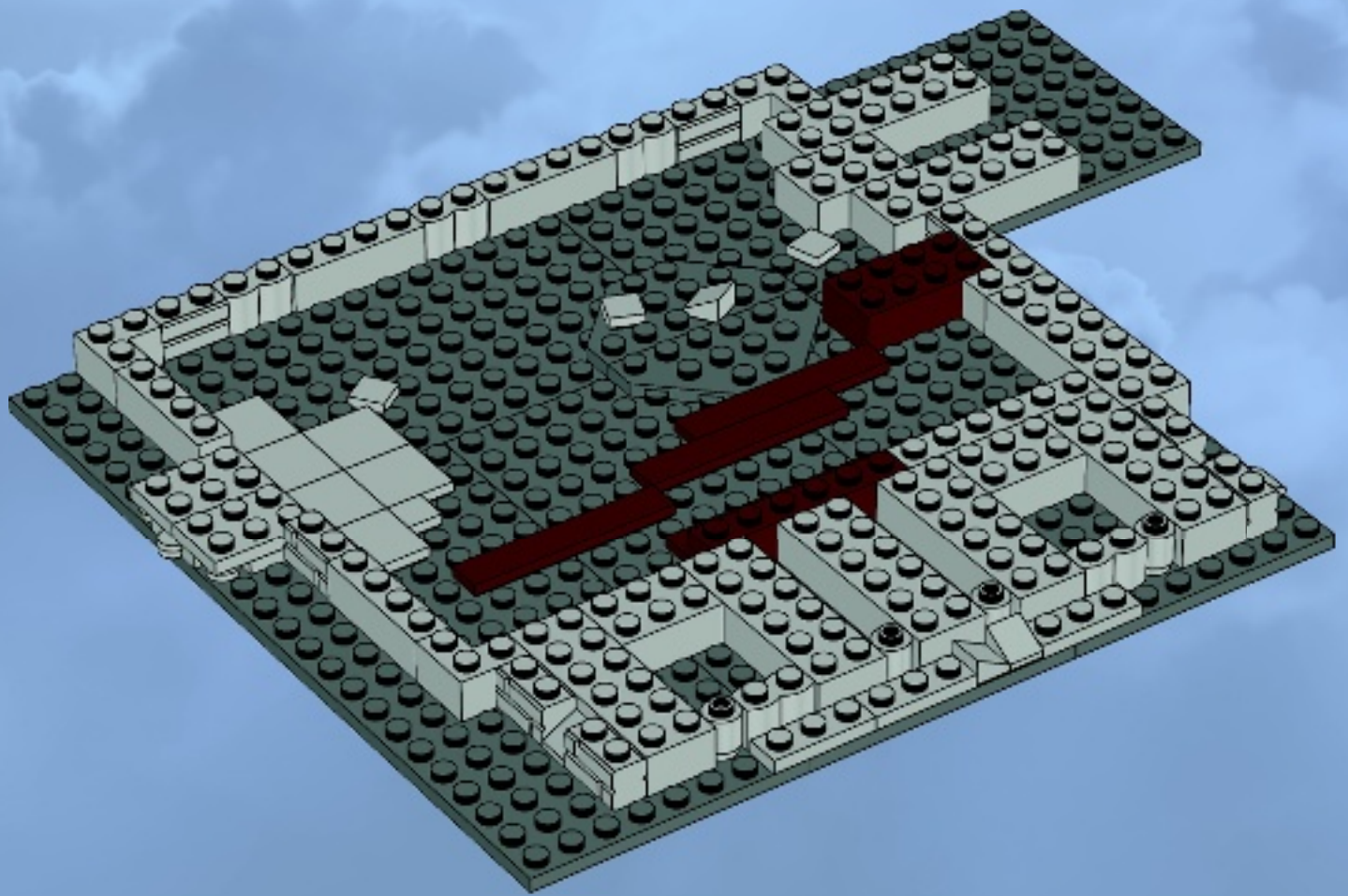



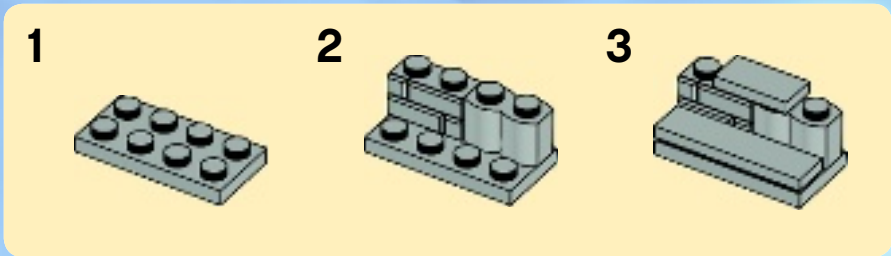
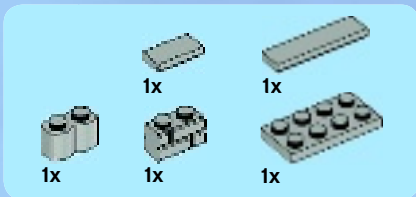

15

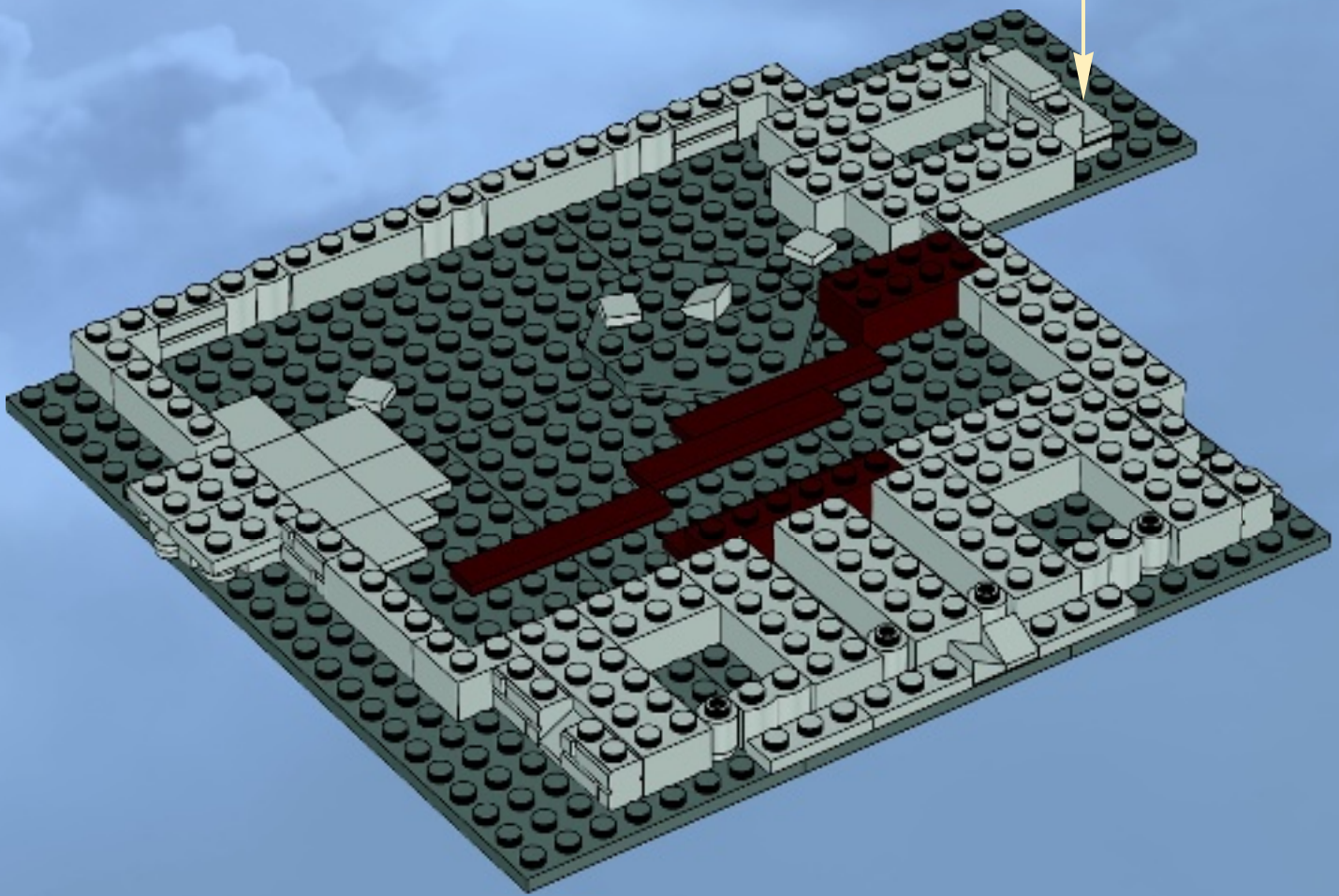

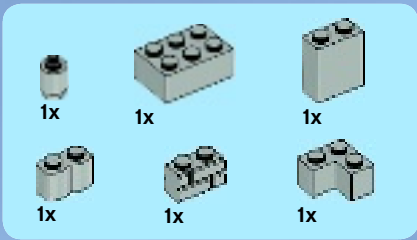

# 16

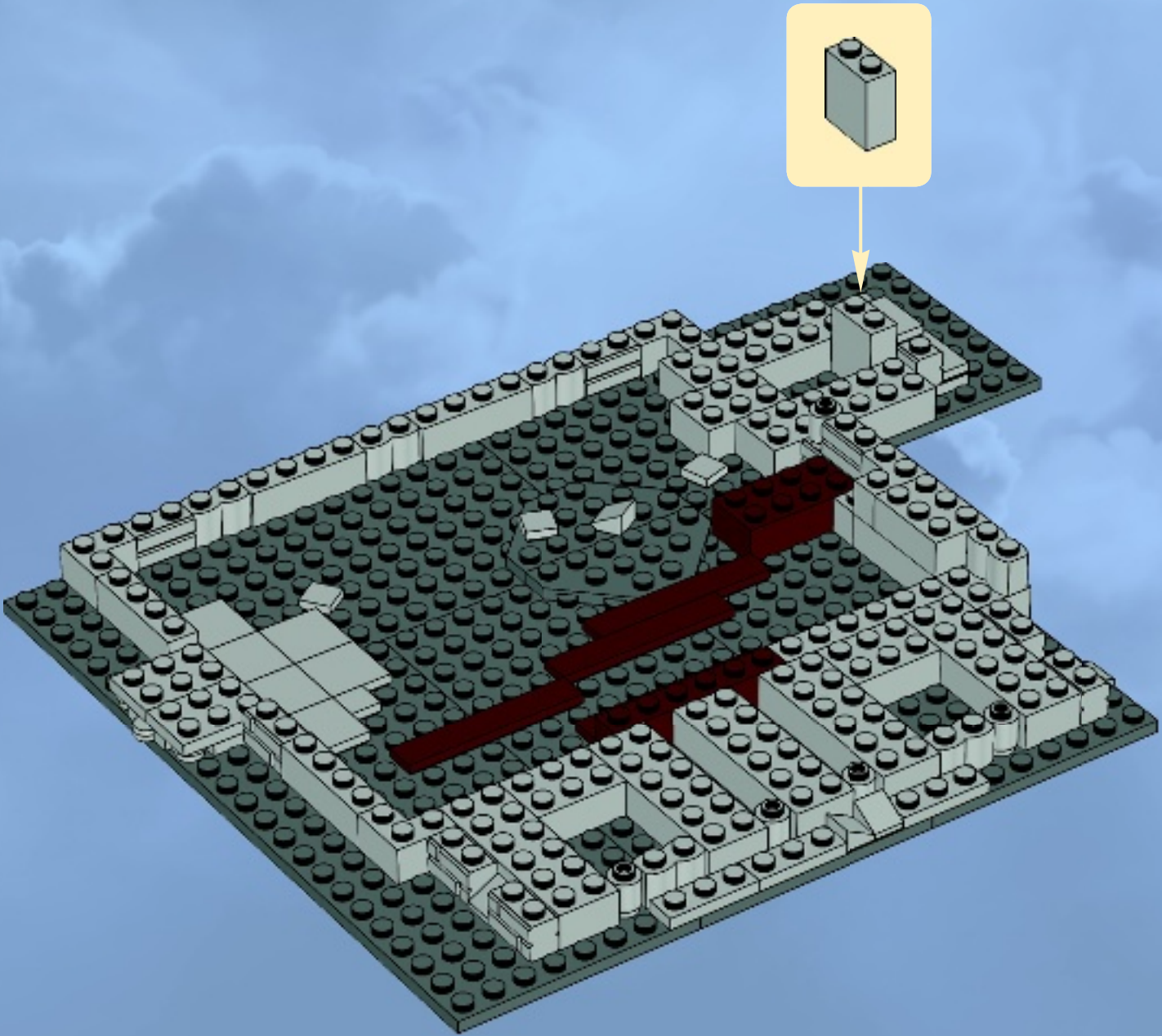



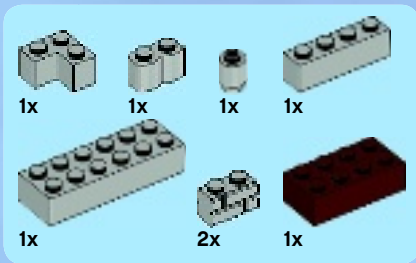

# 17

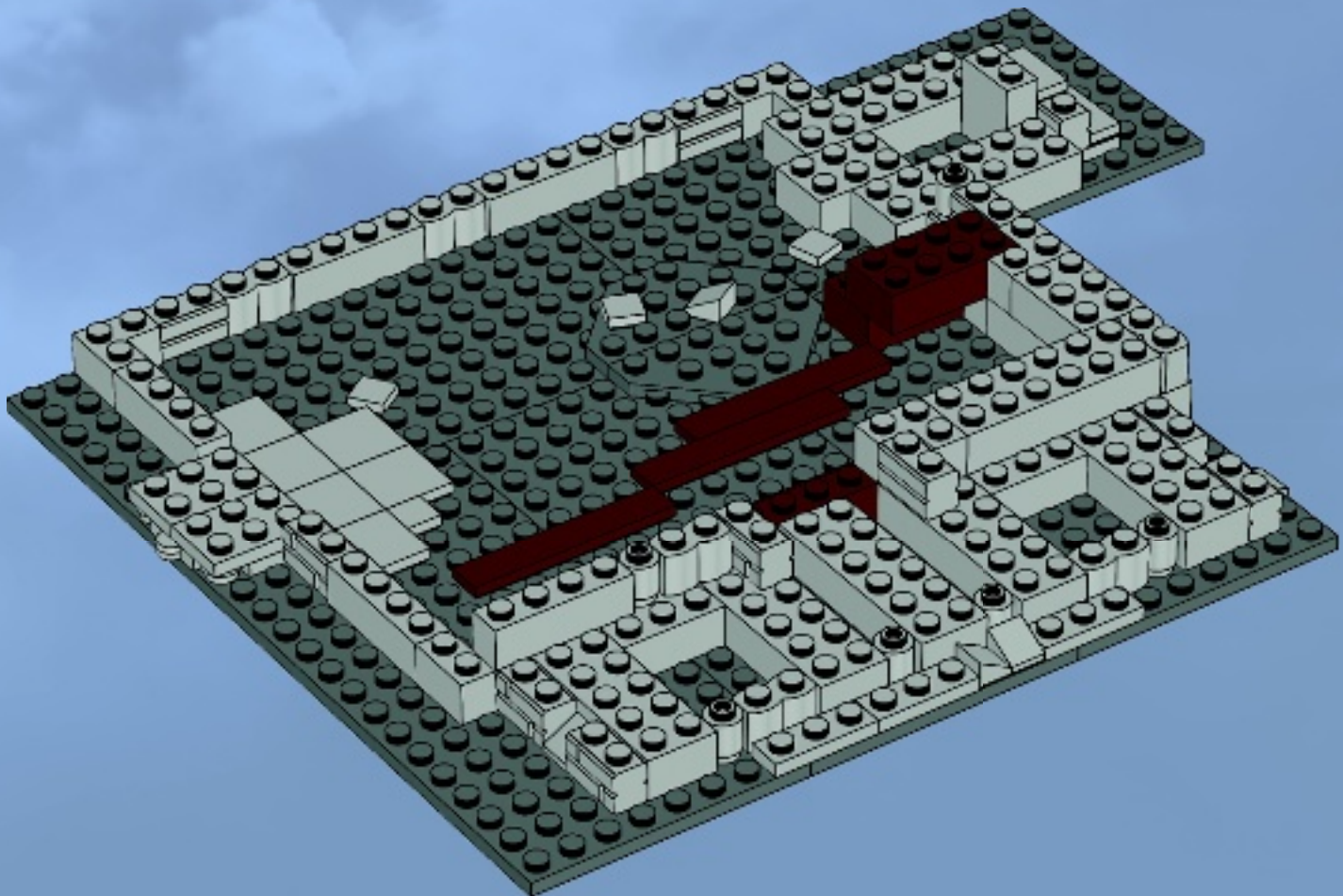

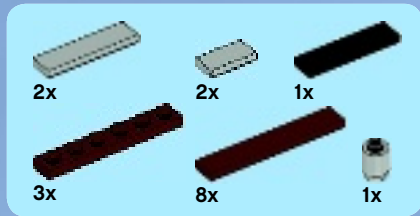

# 18

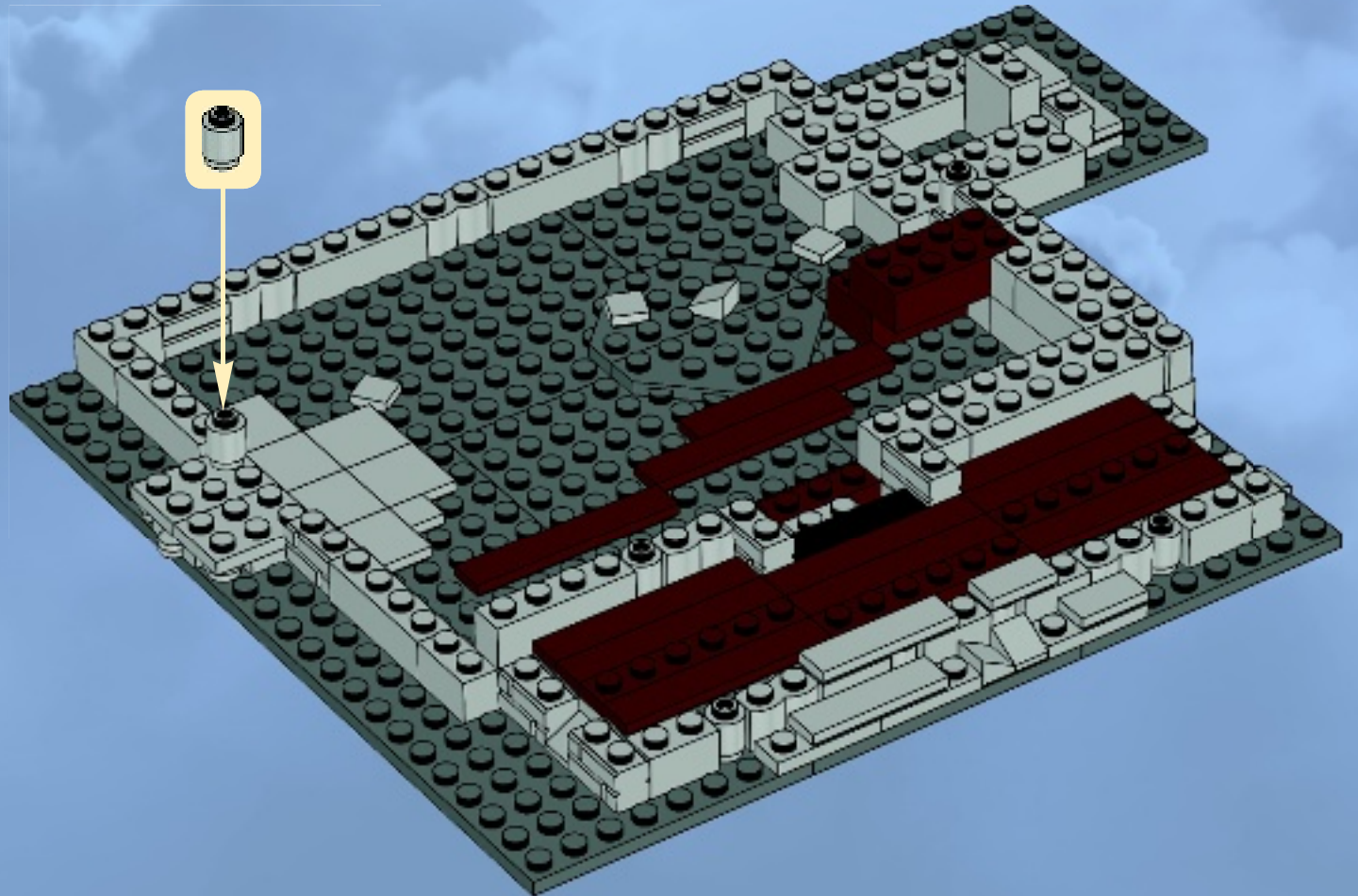





1x

1



1x



1x

2

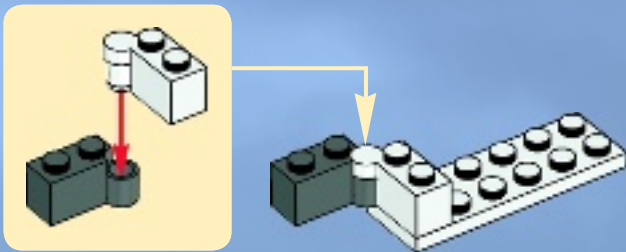

1x



1x



2x

3

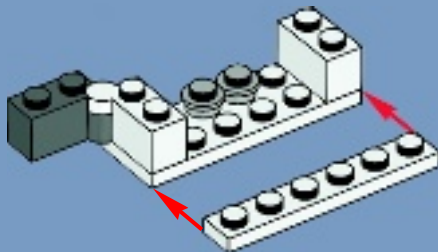

2x



2x

4

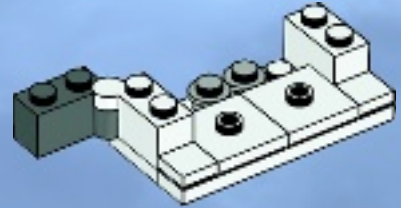

1x



1x

5

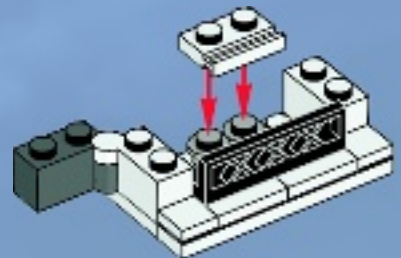

2x

6





2x



1x



2x

# 7

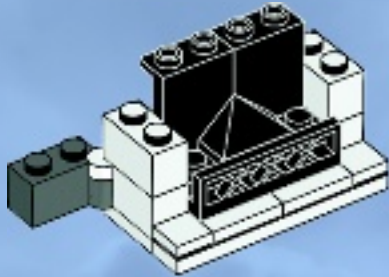

2x



1x

# 8

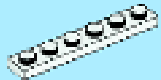
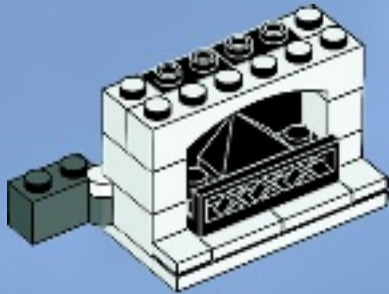

1x



3x

# 9

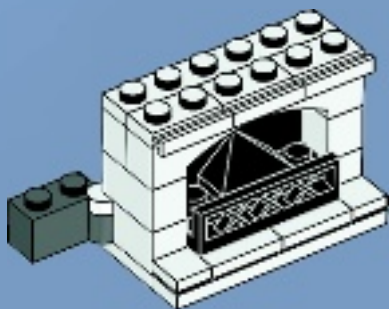

4x

# 10

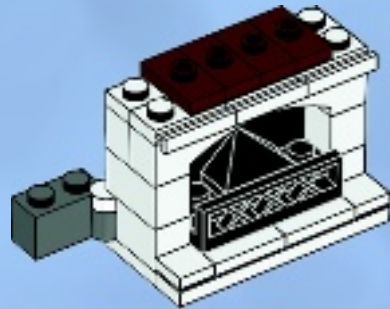

1x



2x

# 11

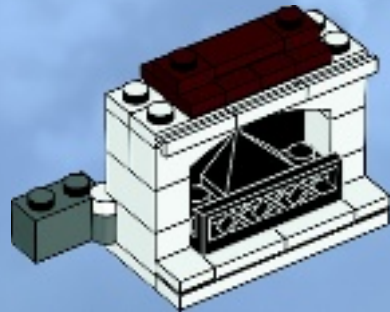

1x



1x

# 12

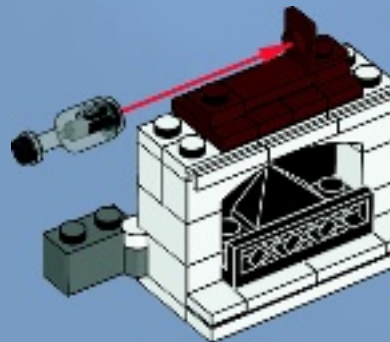

19

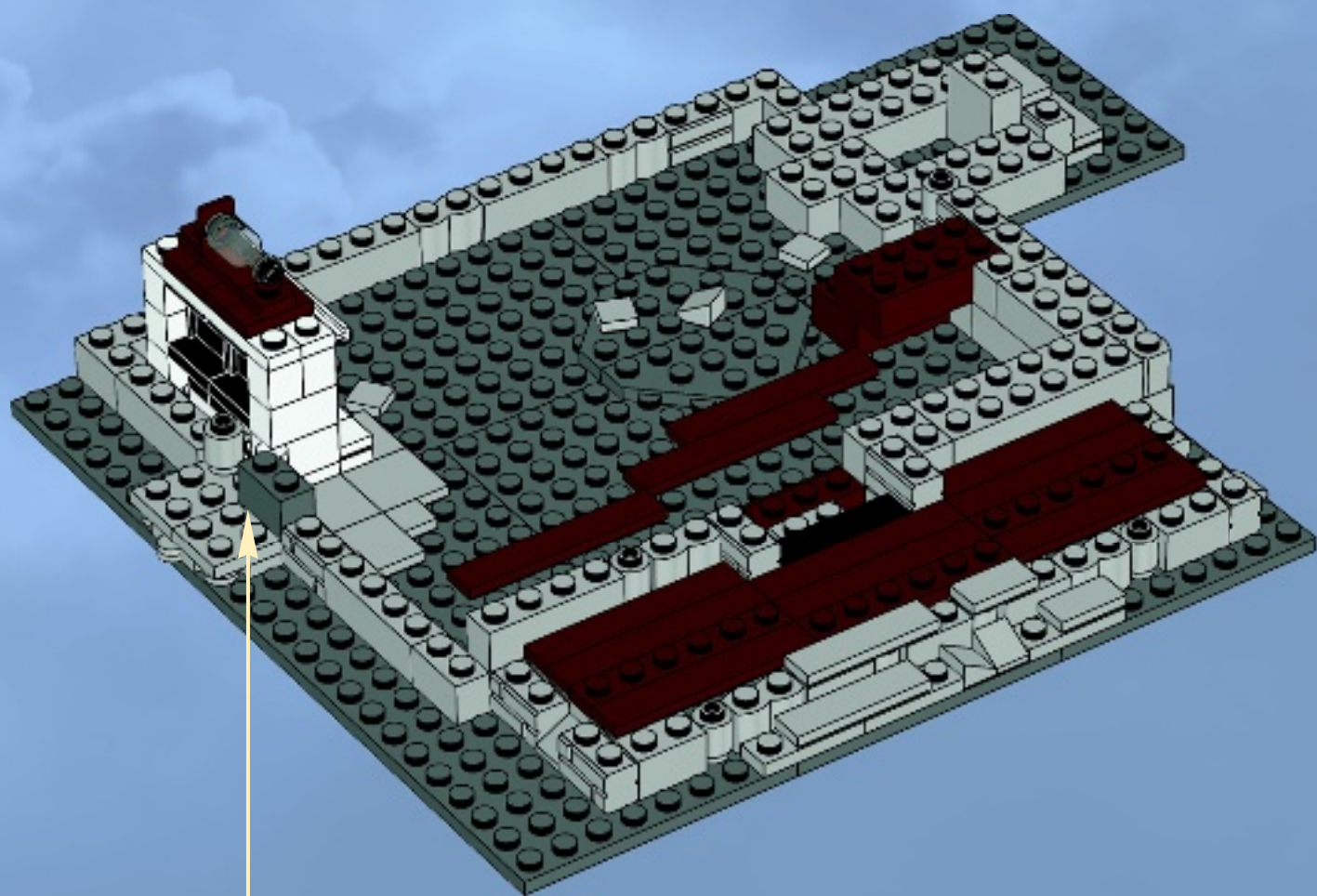



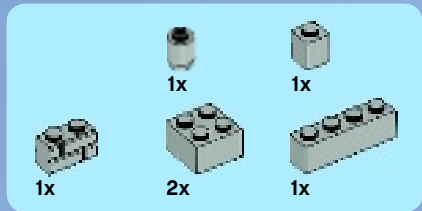

20

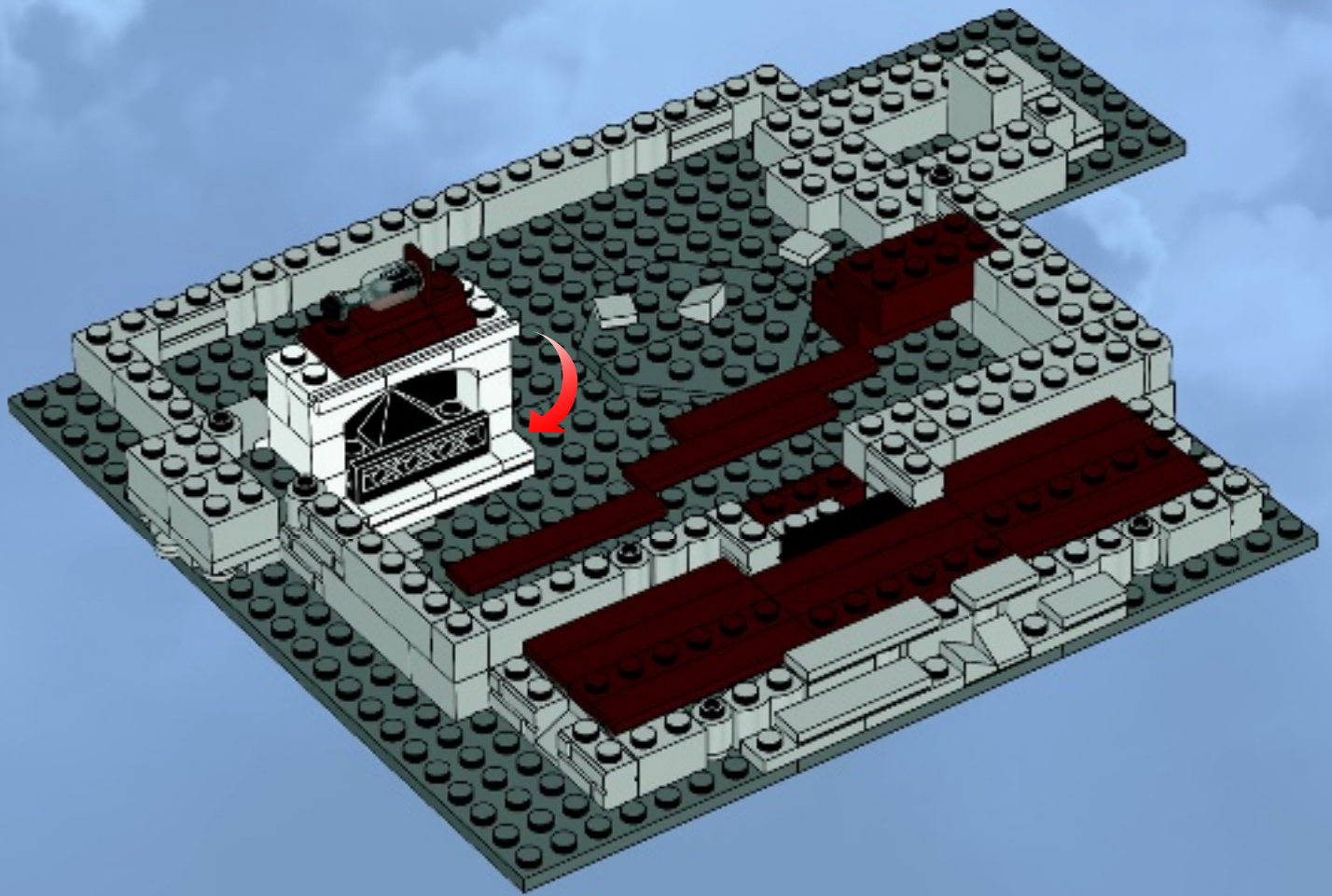

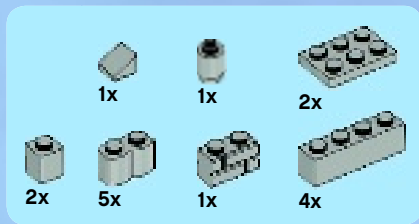

# 21

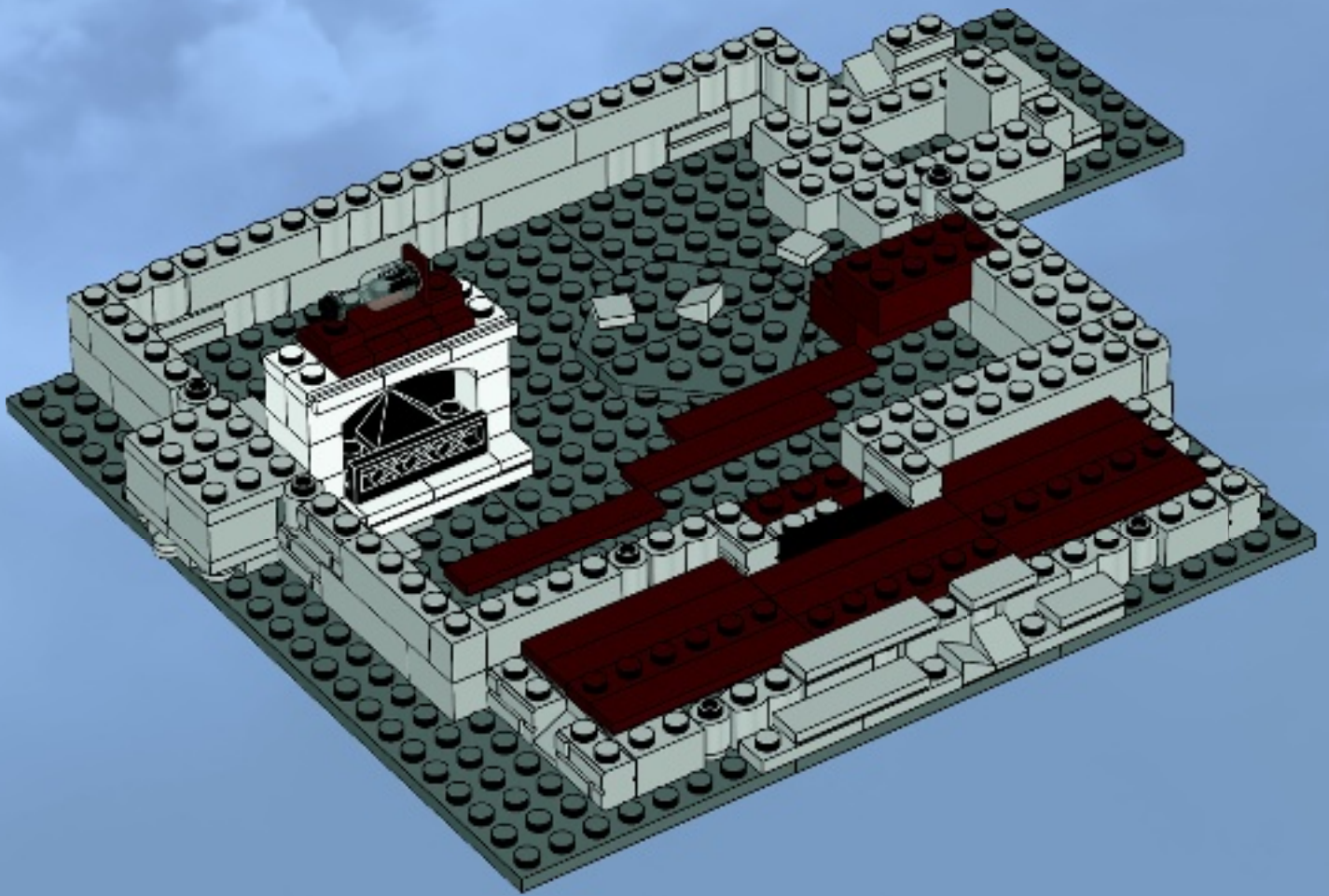

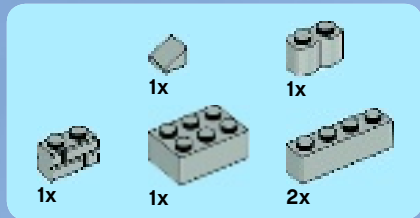

22

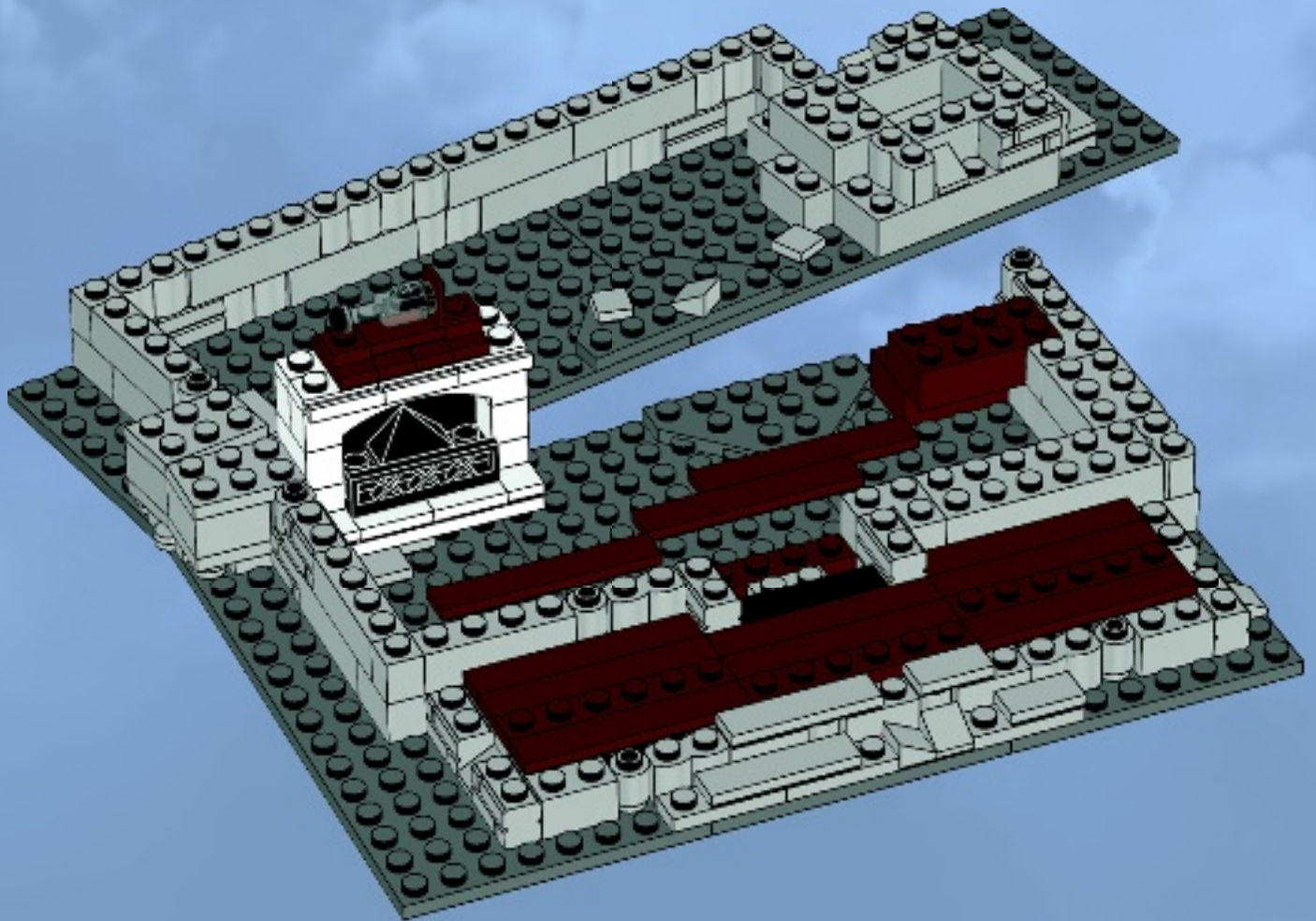



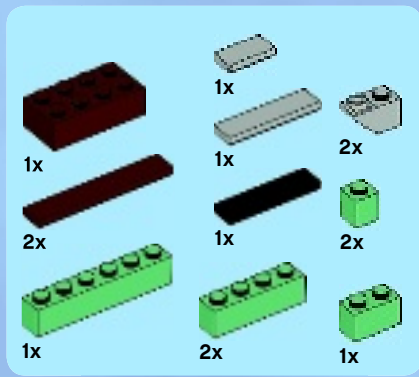

# 23

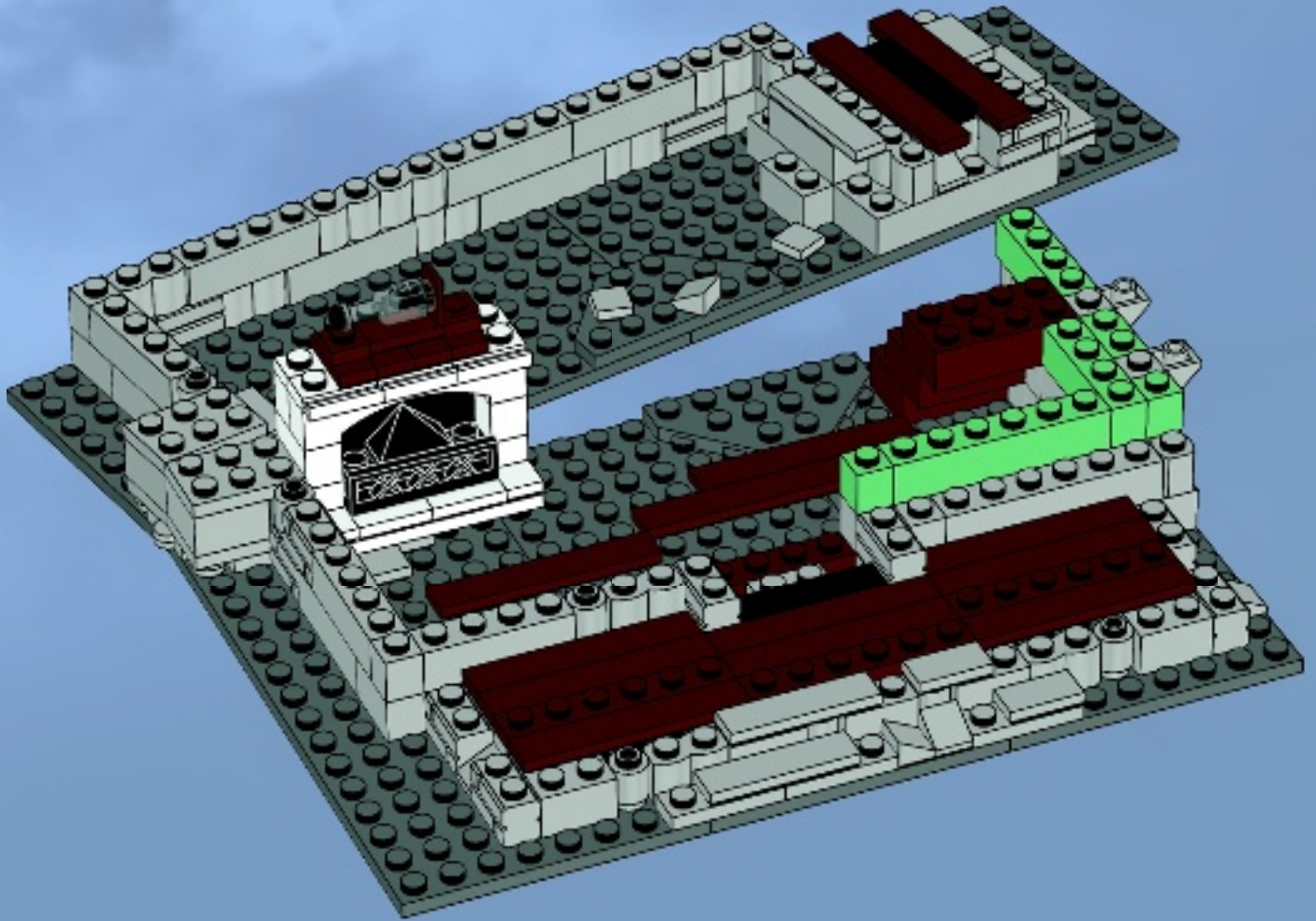

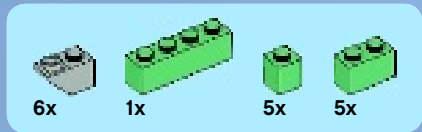

# 24

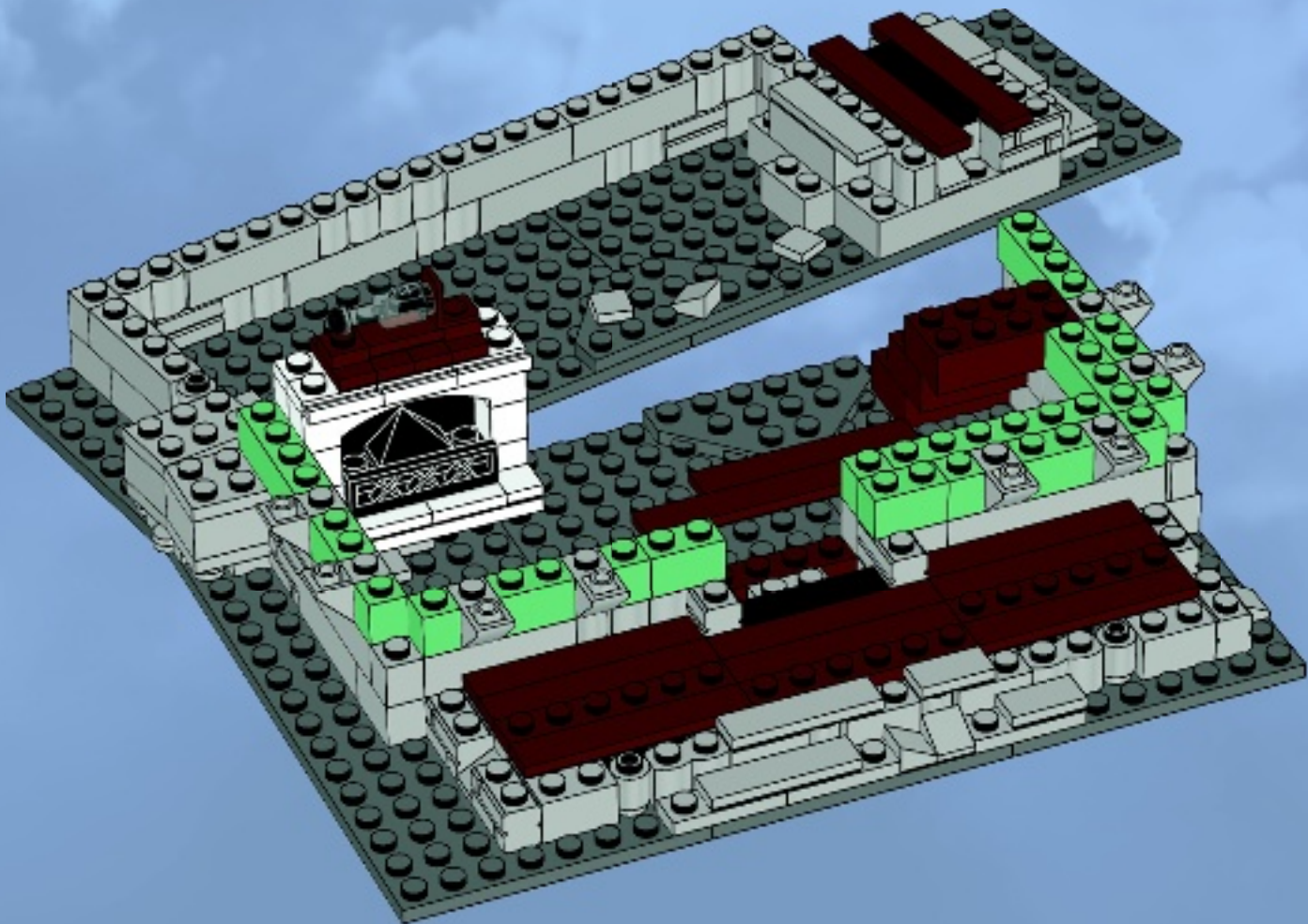

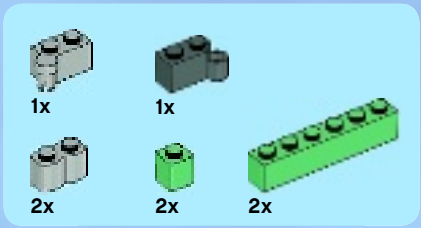

# 25

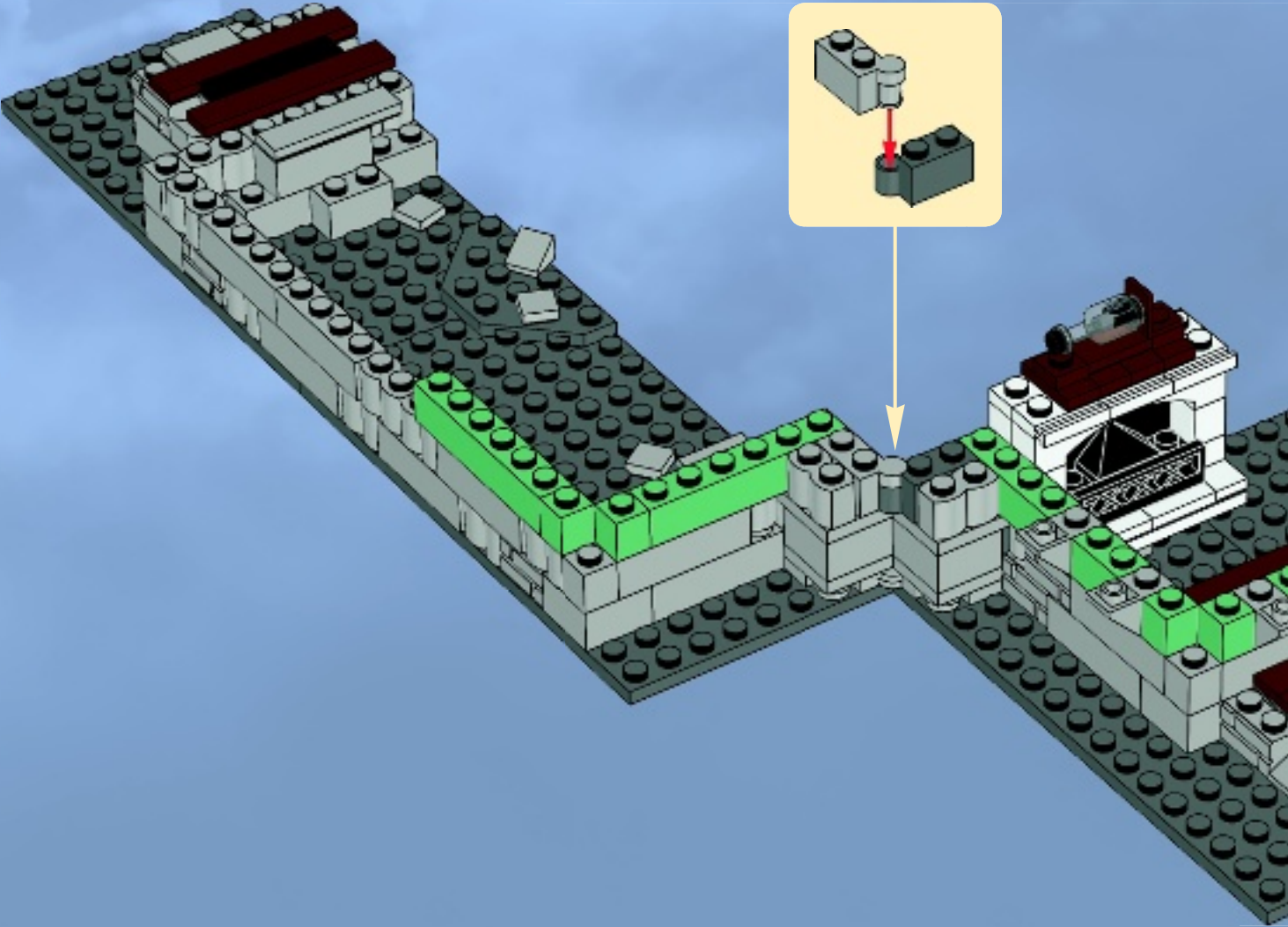



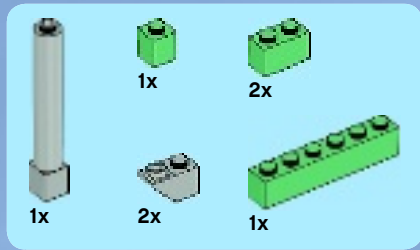

# 26

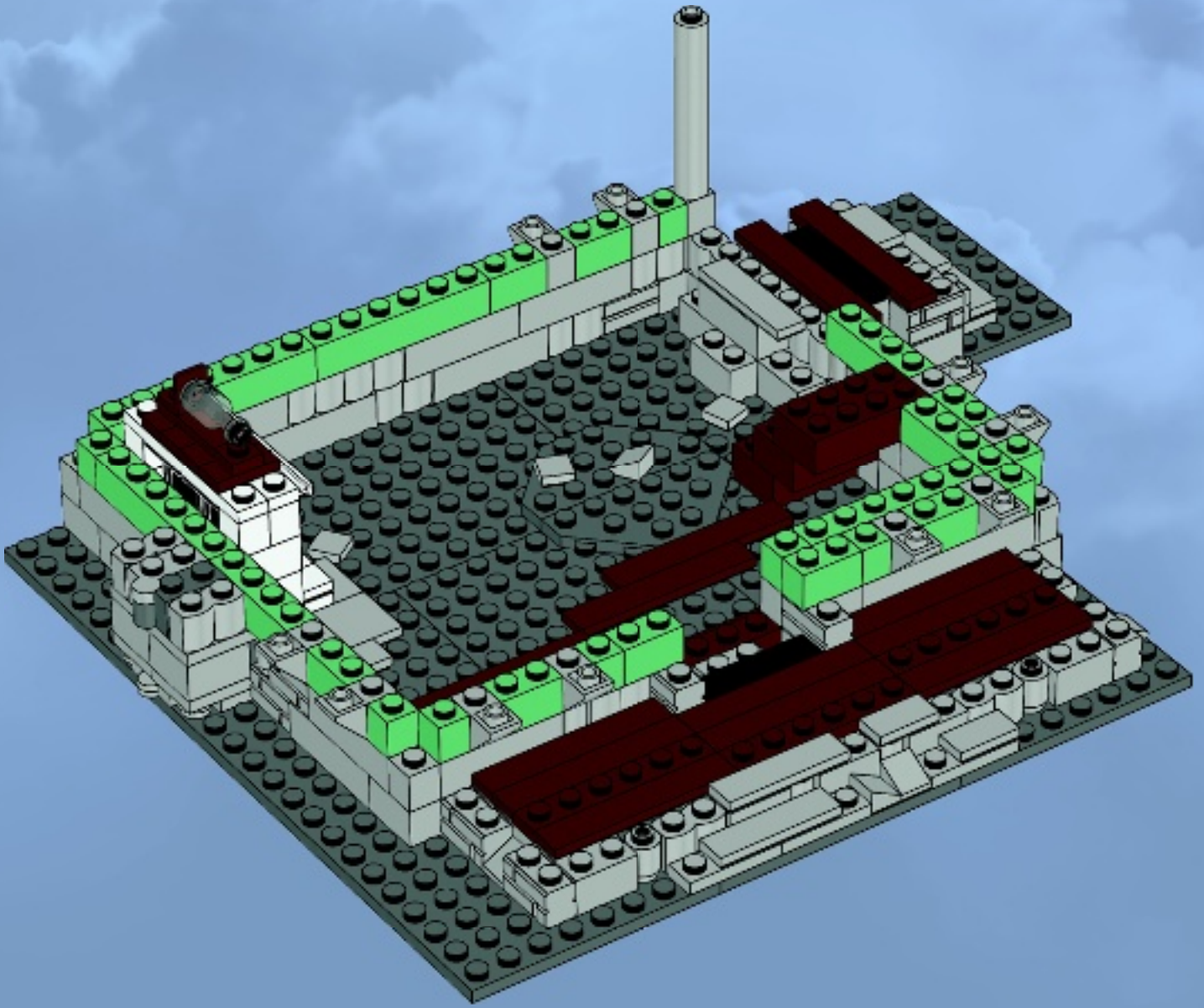

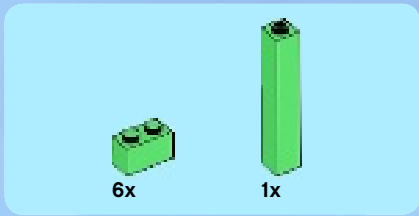

27

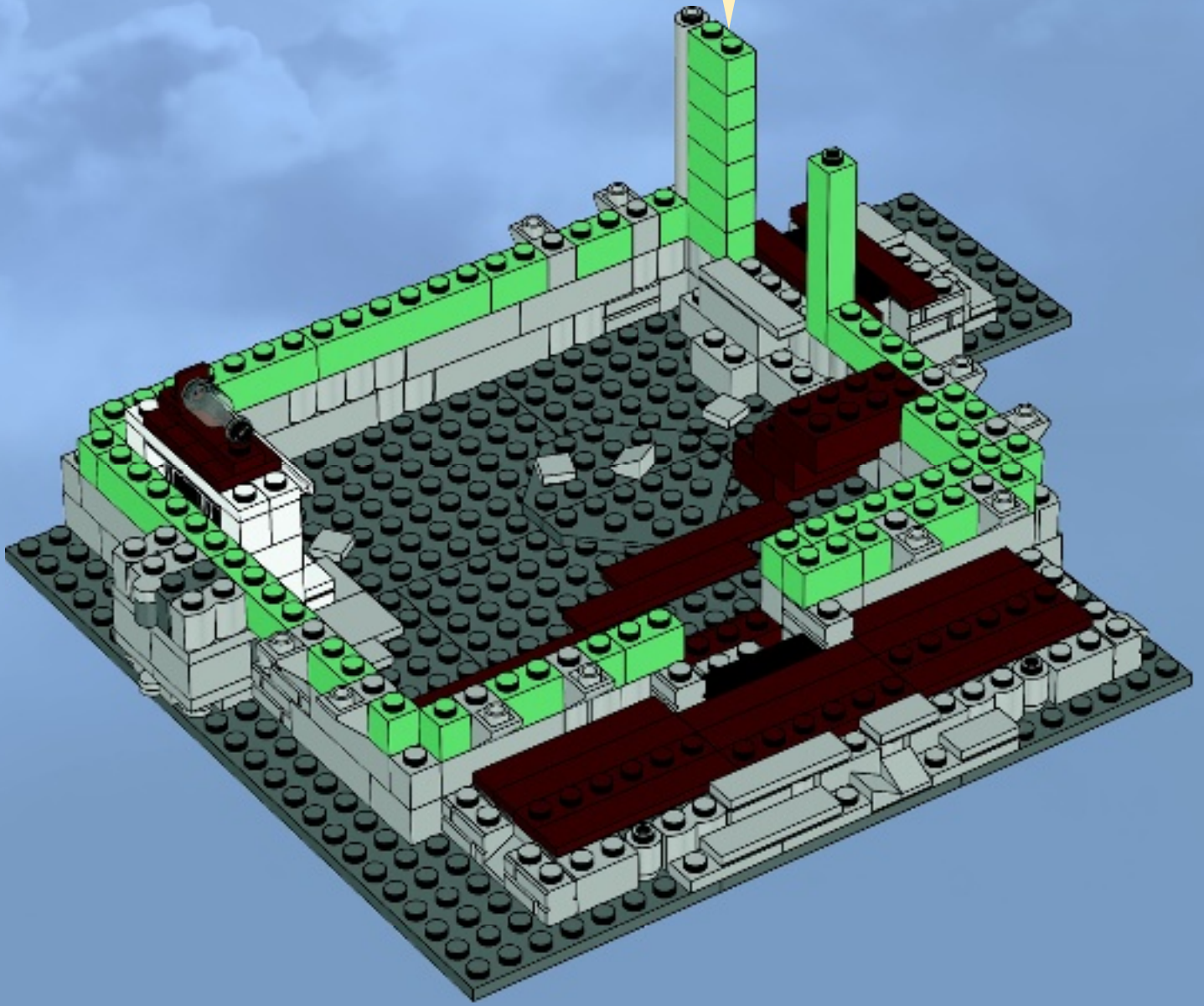
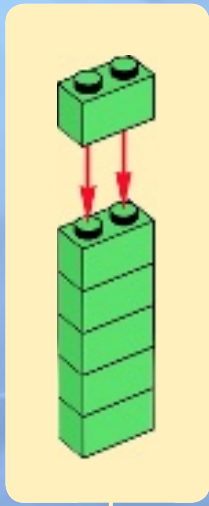



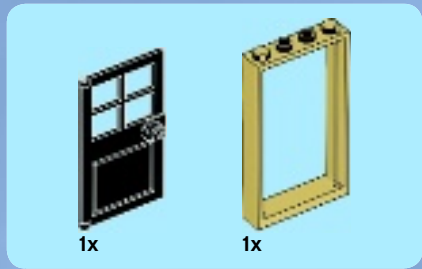

28

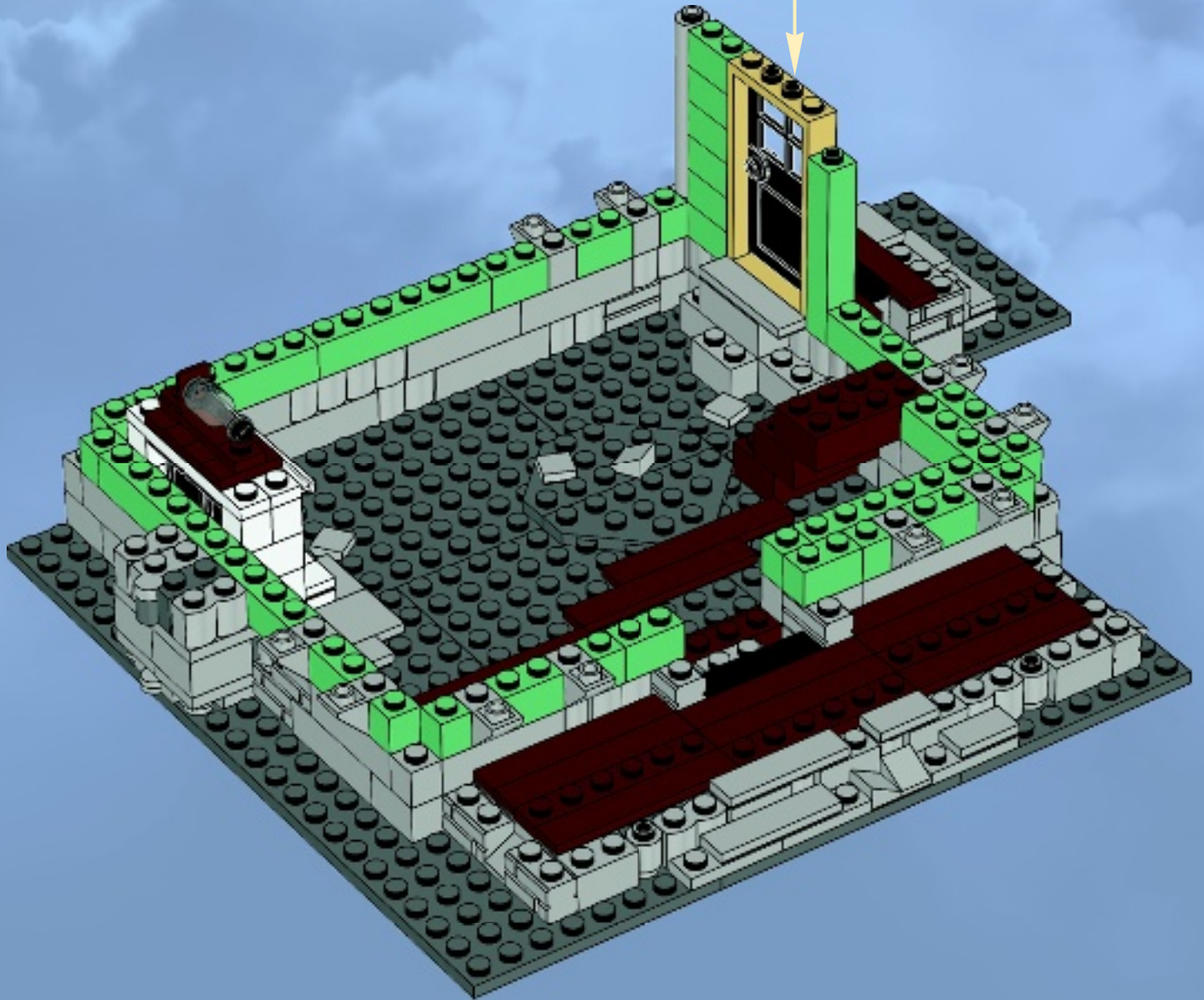
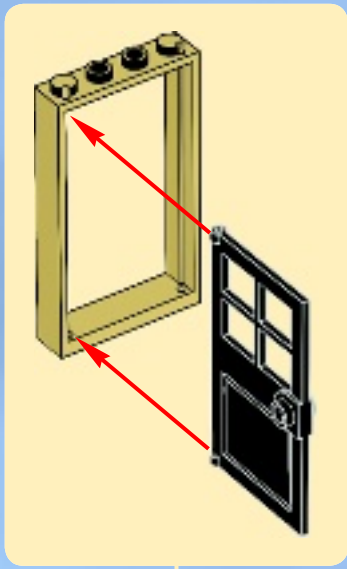





4x

# 29

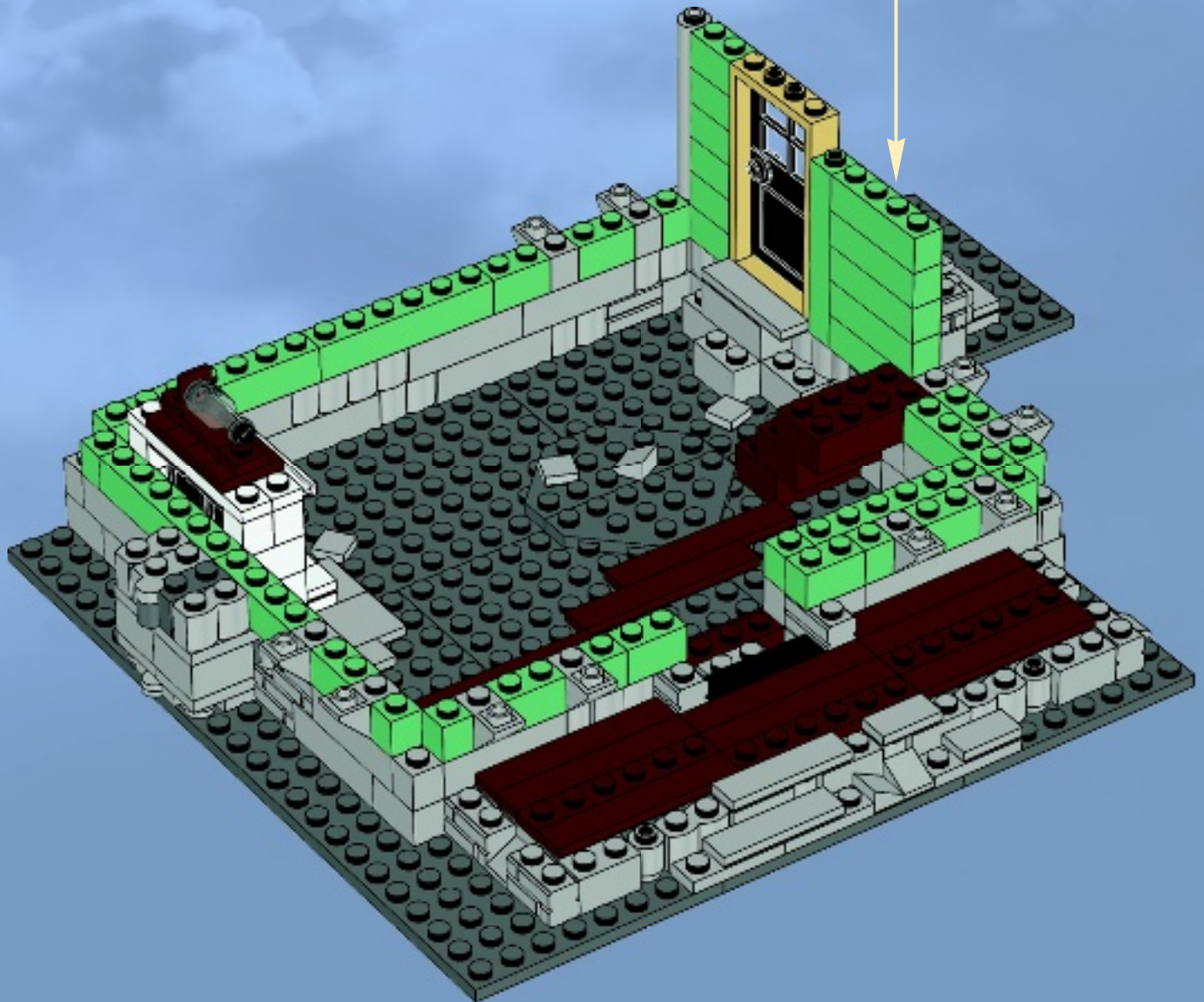
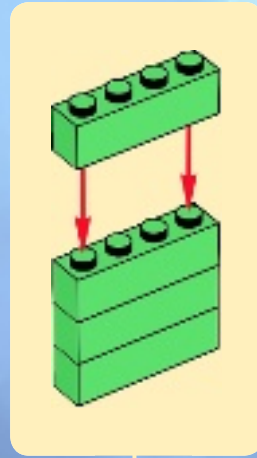

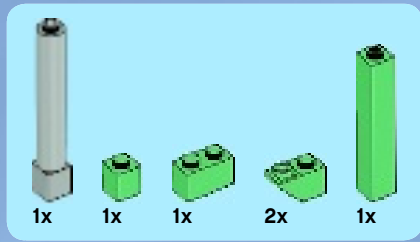

30

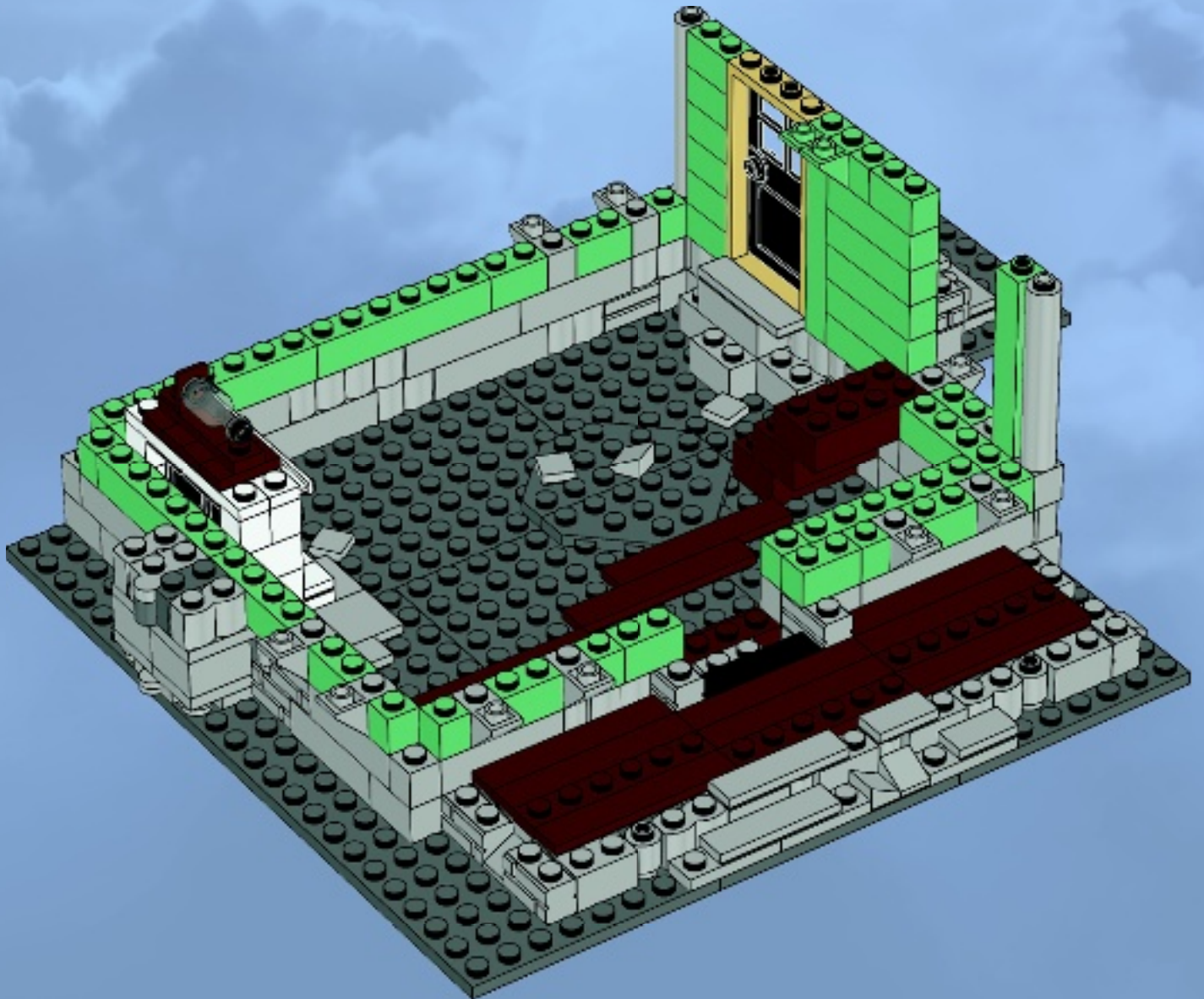



1x

1

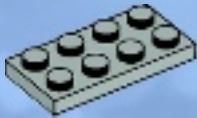

1x



2x

2



1x



2x



1x

3

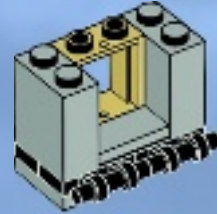

1x



1x



1x



1x

4

1

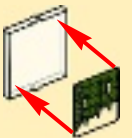

2

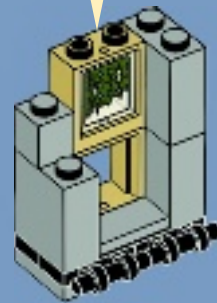





1x

5



1x



2x

7

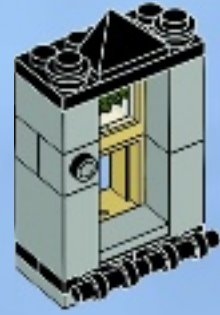

1x



1x

6

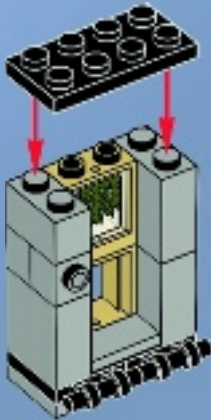

2x



1x

8



31

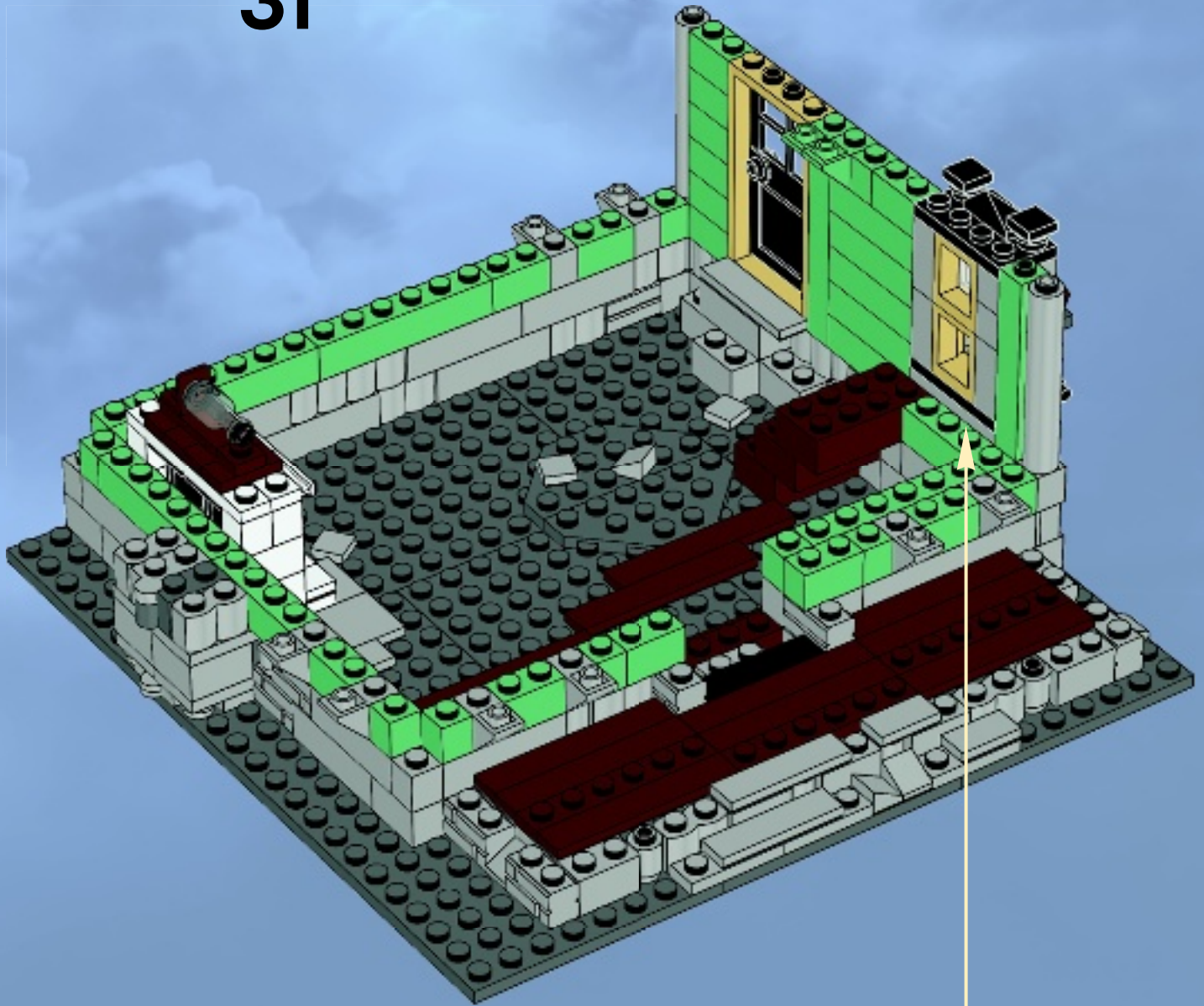

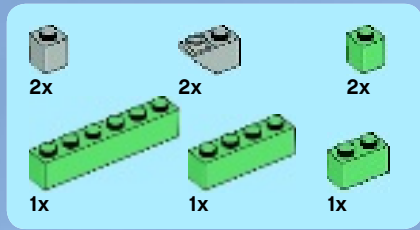

# 32

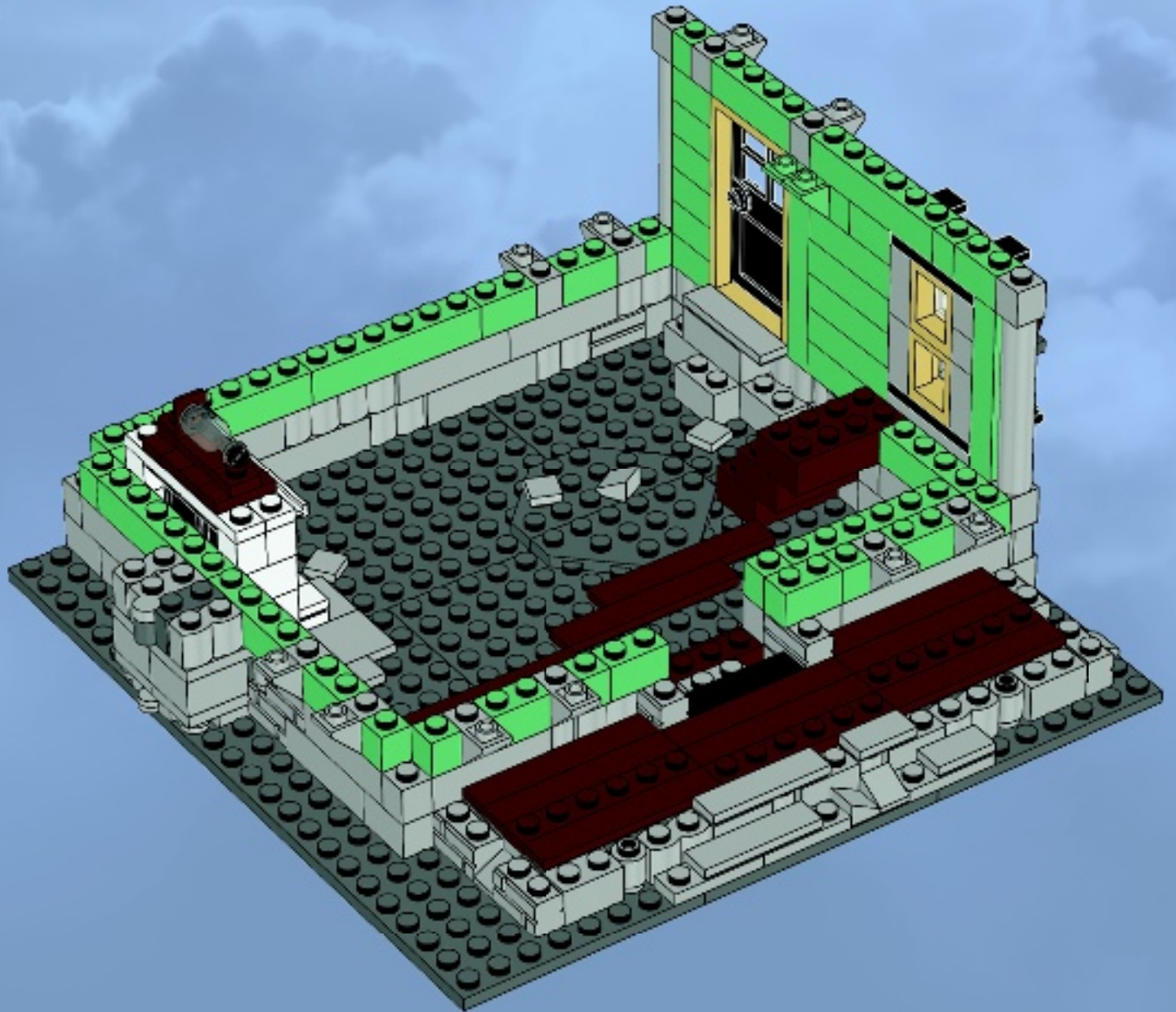



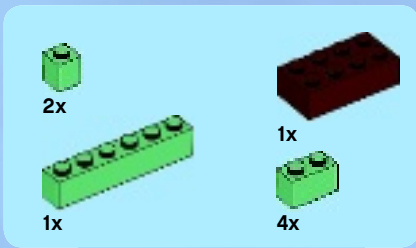

# 33

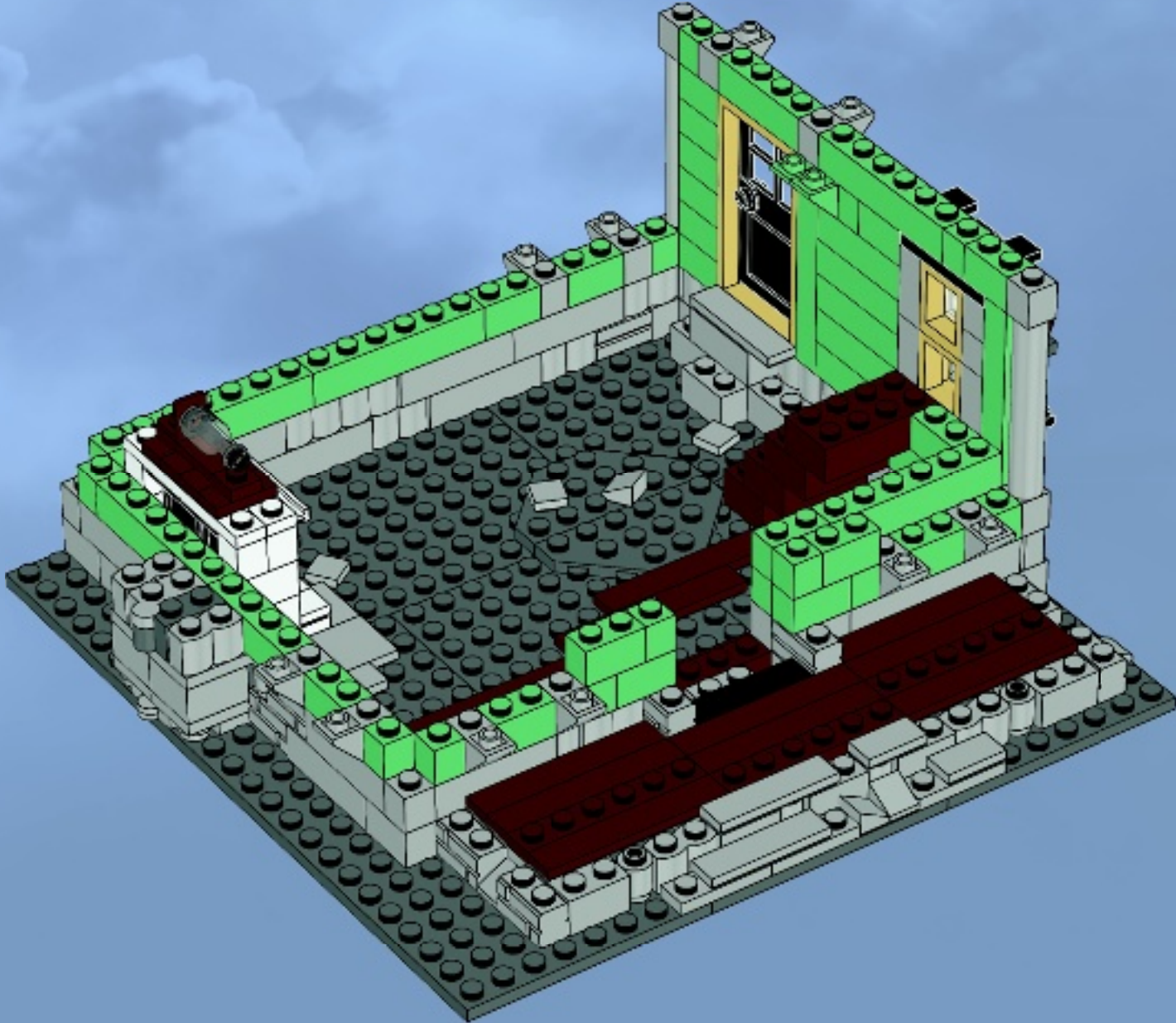

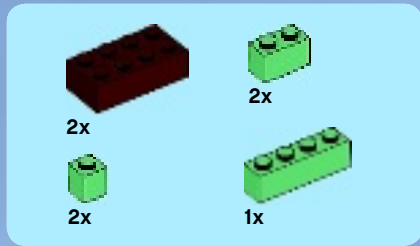

# 34

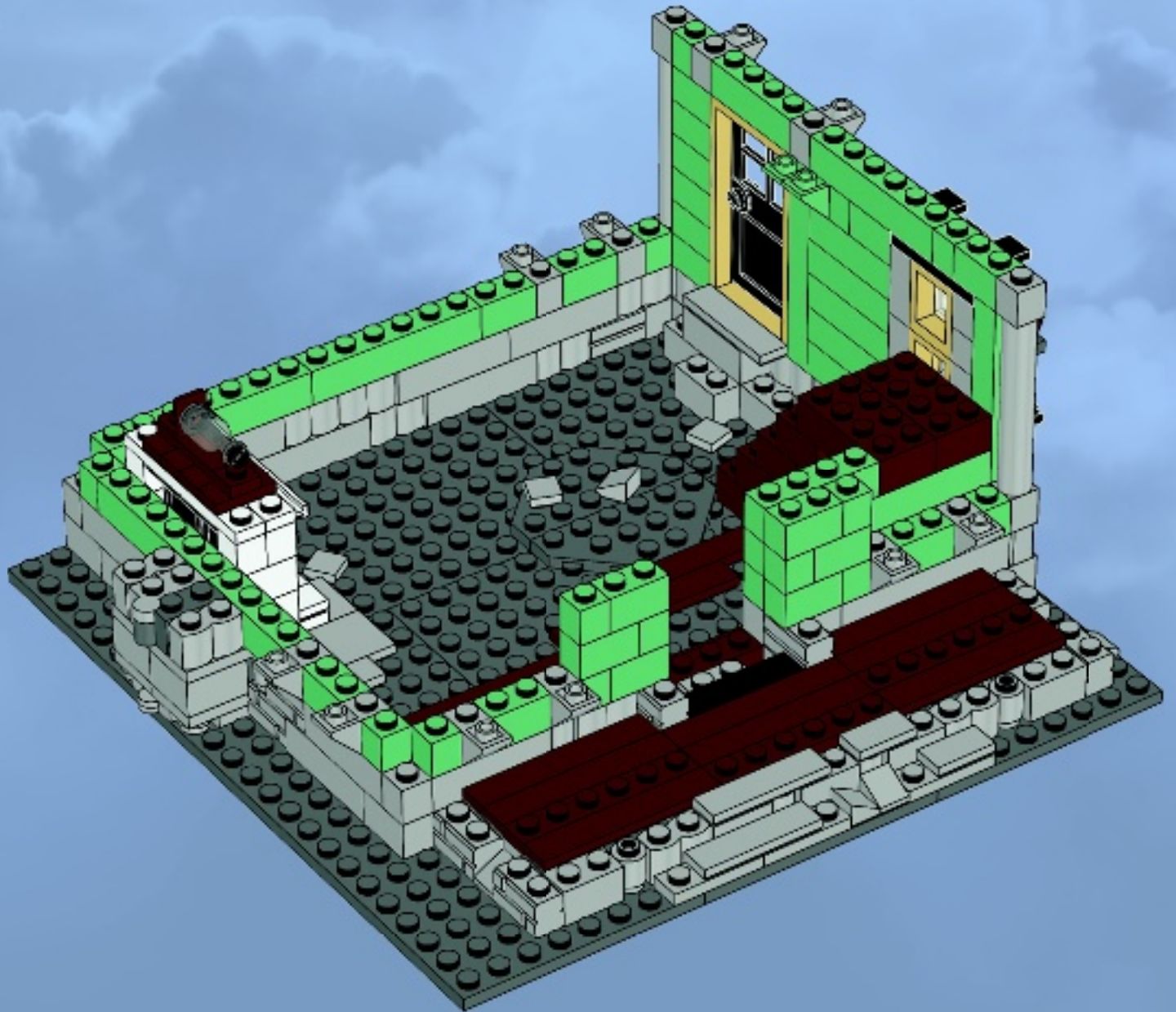





# 35

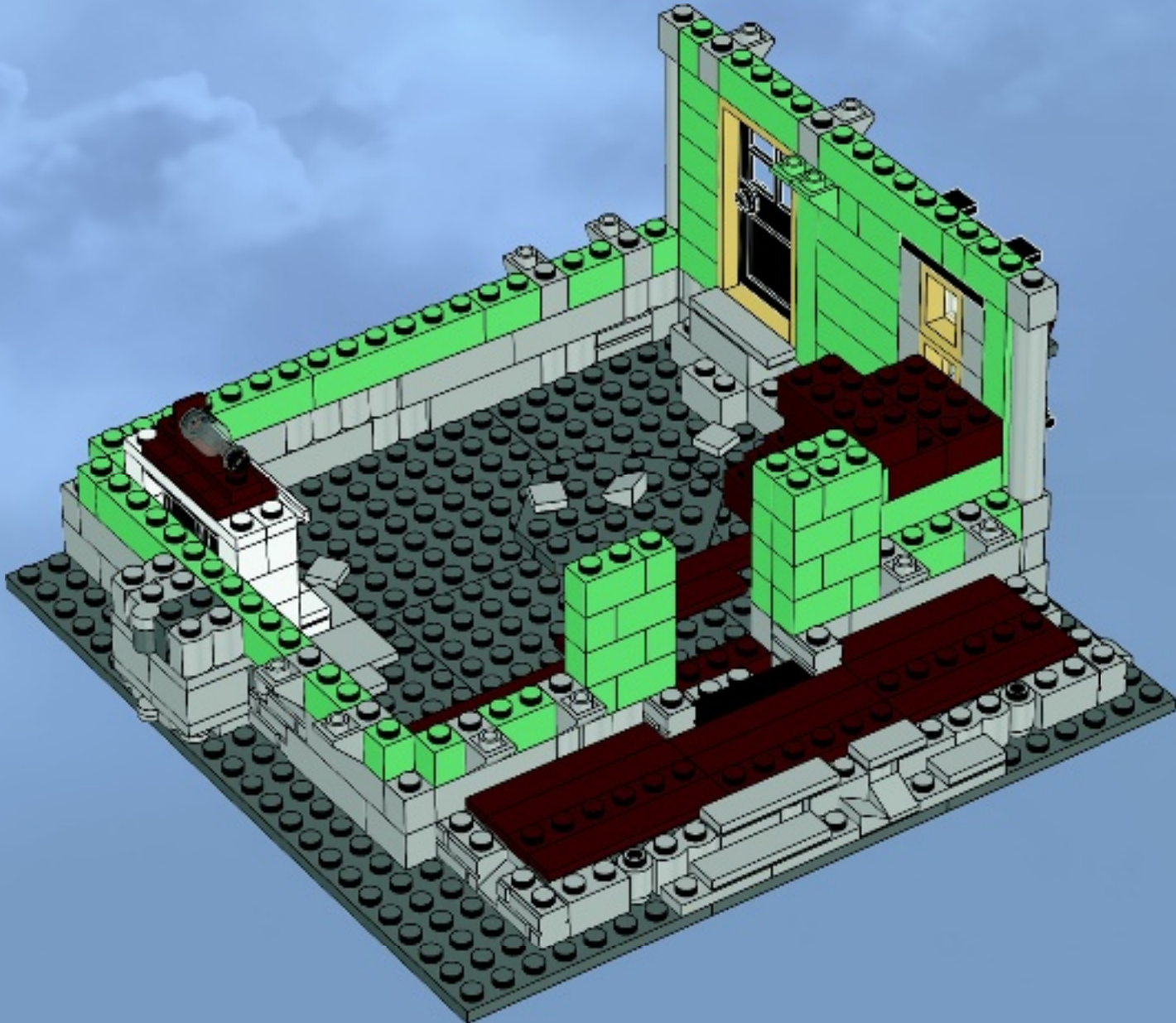



1x  2x  3x 

# 36

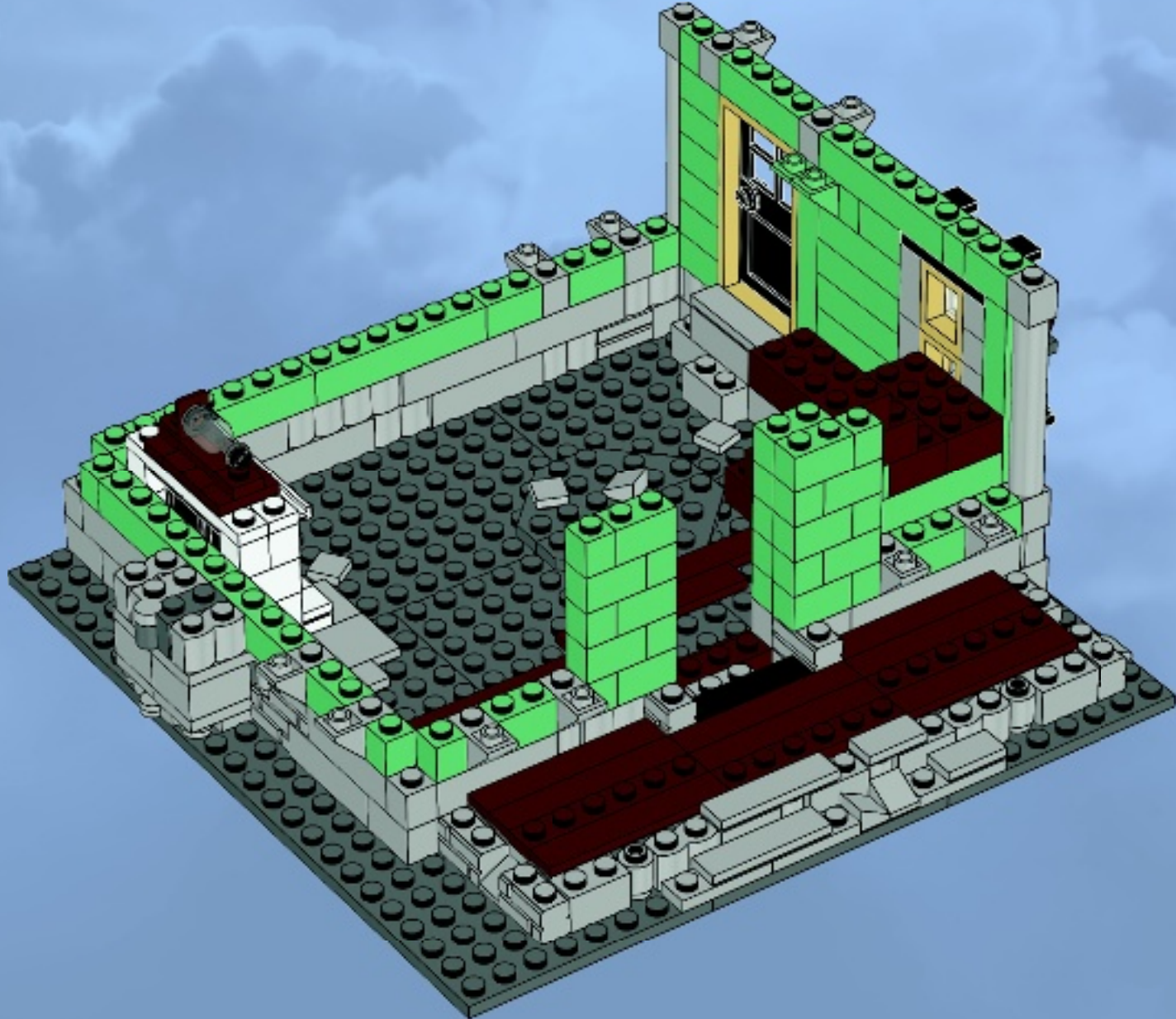



37

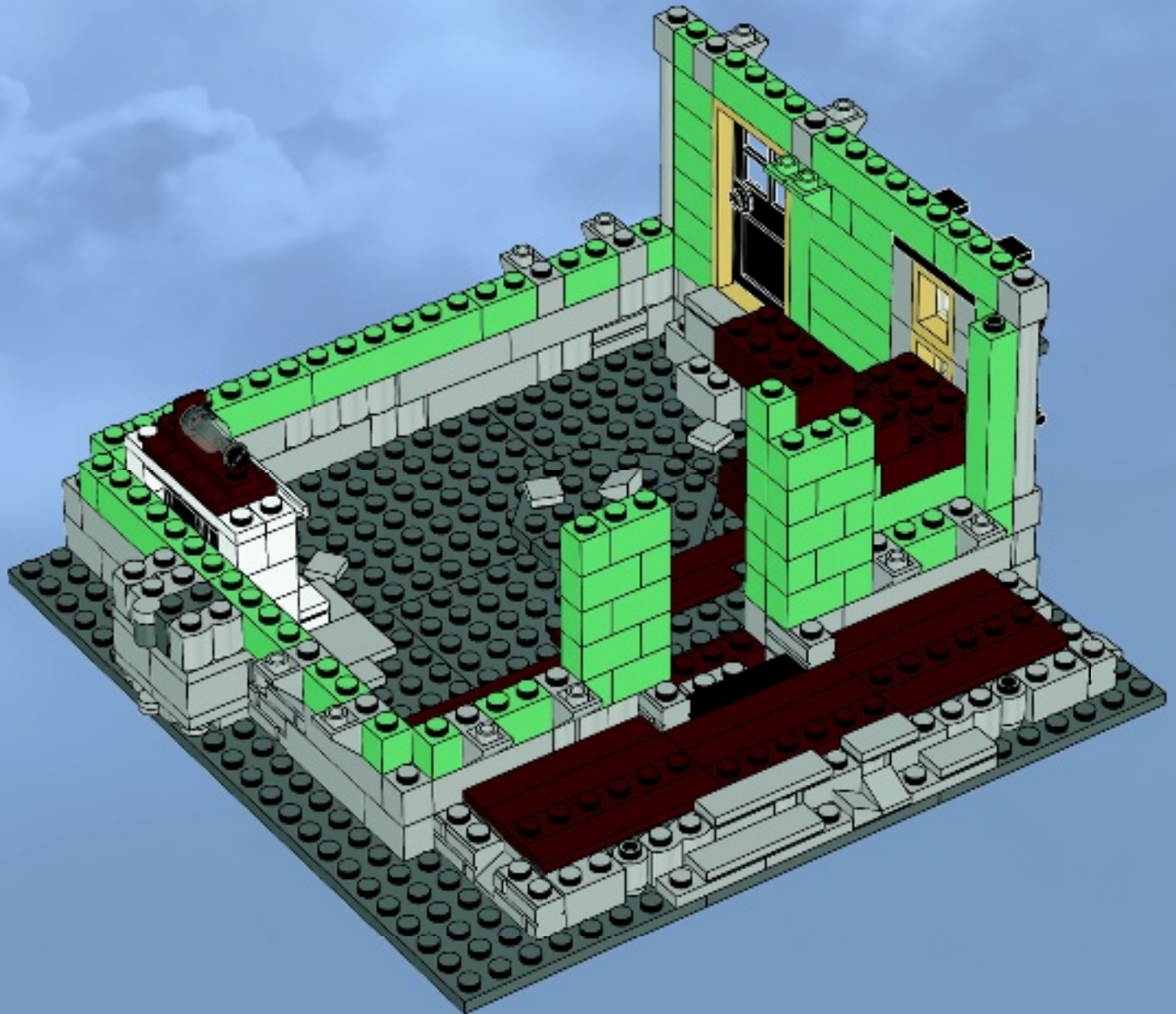



1x

1

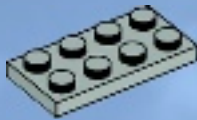

1x



2x

2



1x



2x



1x

3

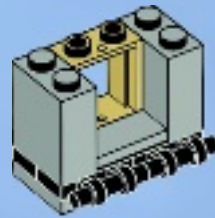

1x



1x

4

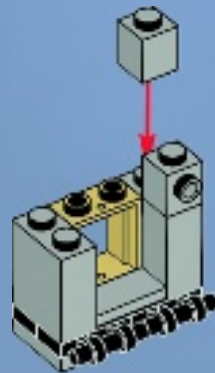





1x



1x

5

1

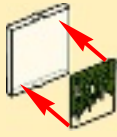

2



1x



2x

7

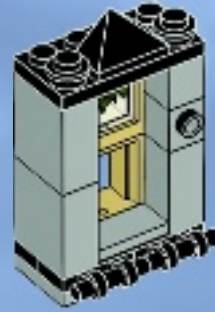

1x



1x



1x

6

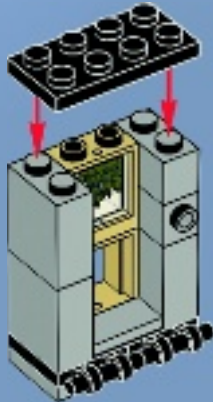

2x



1x

8



38

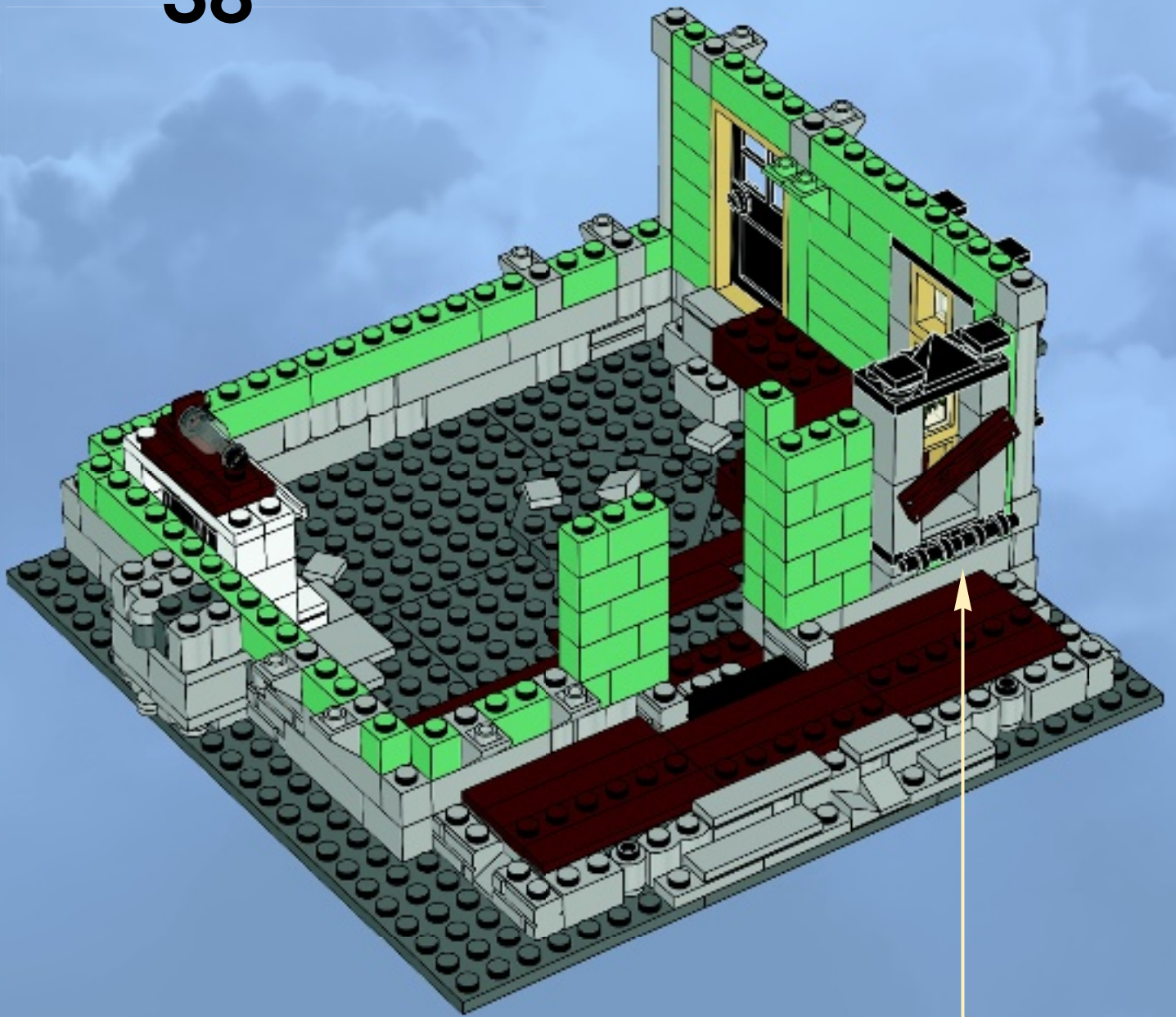

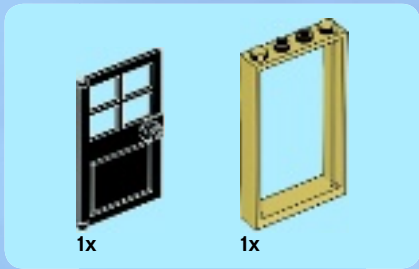

39

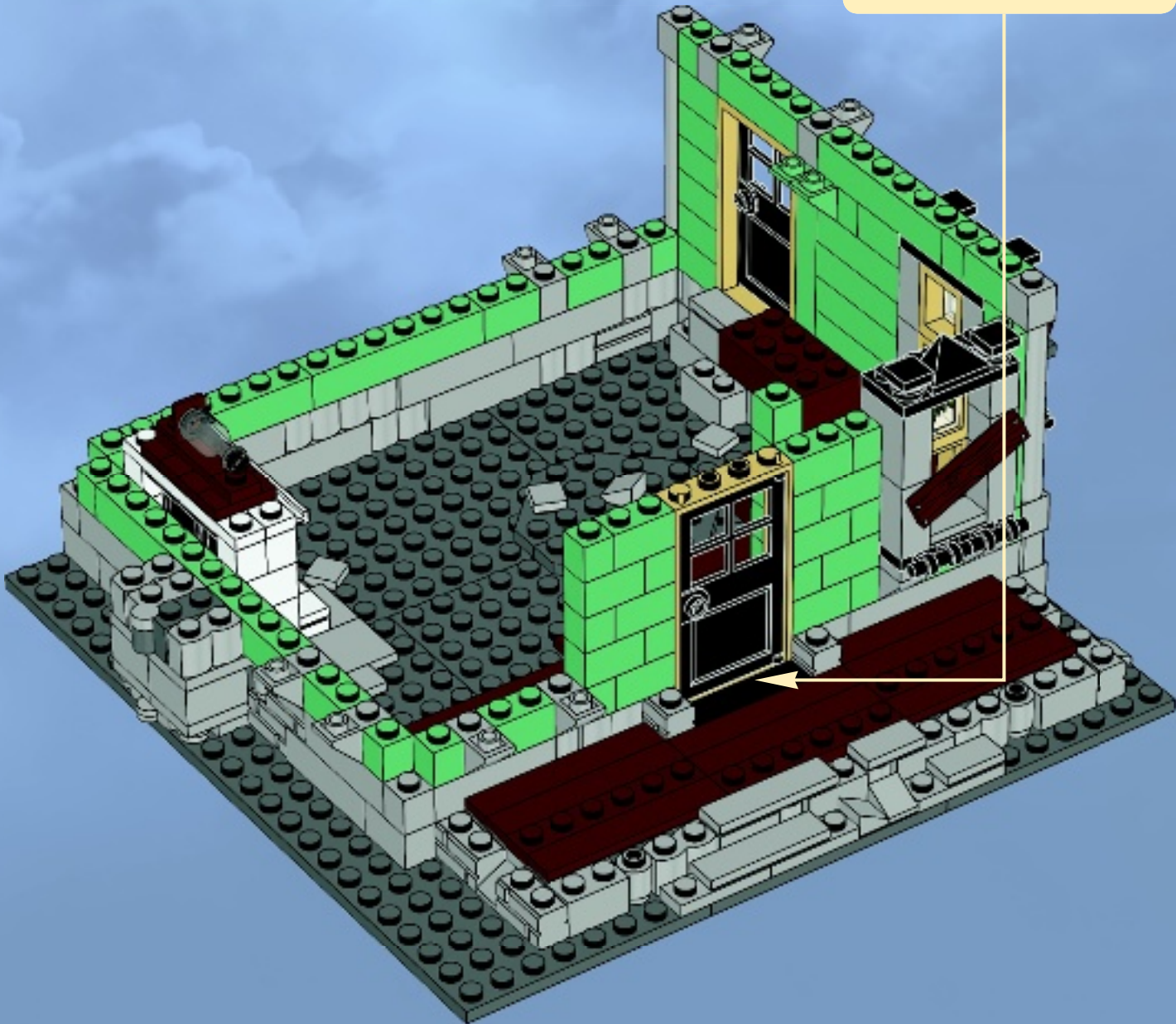
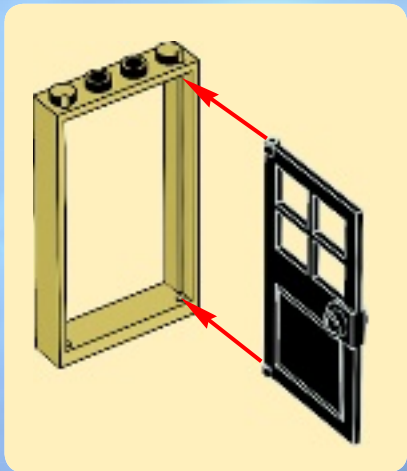



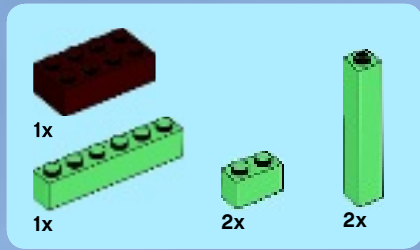

40

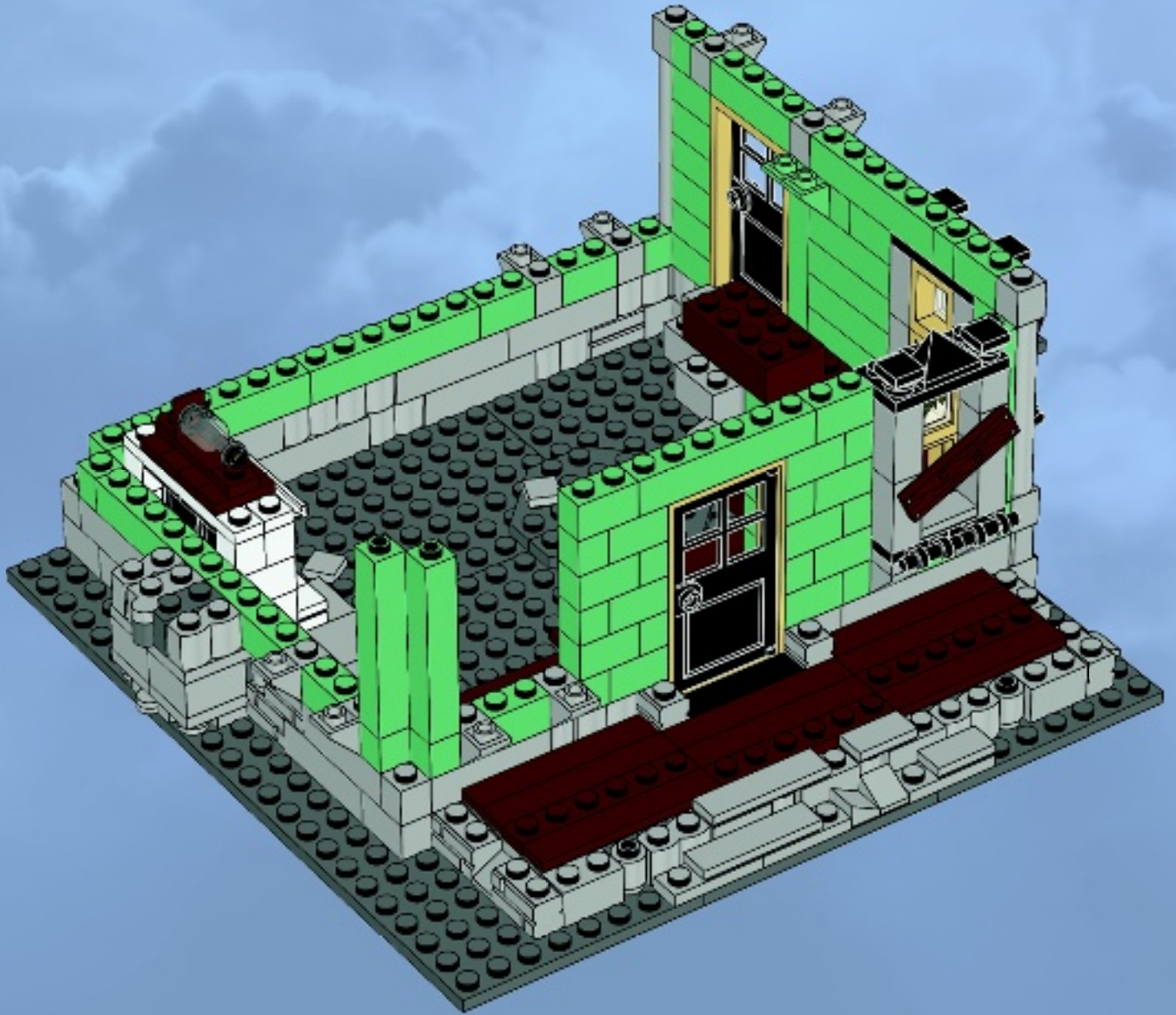



1x

1

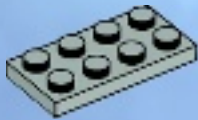

1x



2x

2



1x



2x

3



1x



1x



1x

4

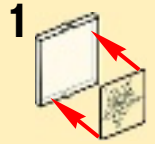
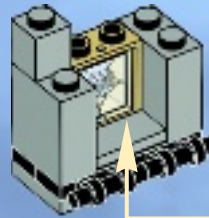

1



2



1x



1x



1x

5



1x



1x

6

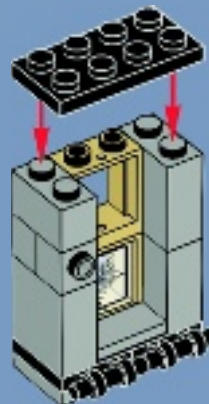



1x



2x

7



2x



1x

8



41

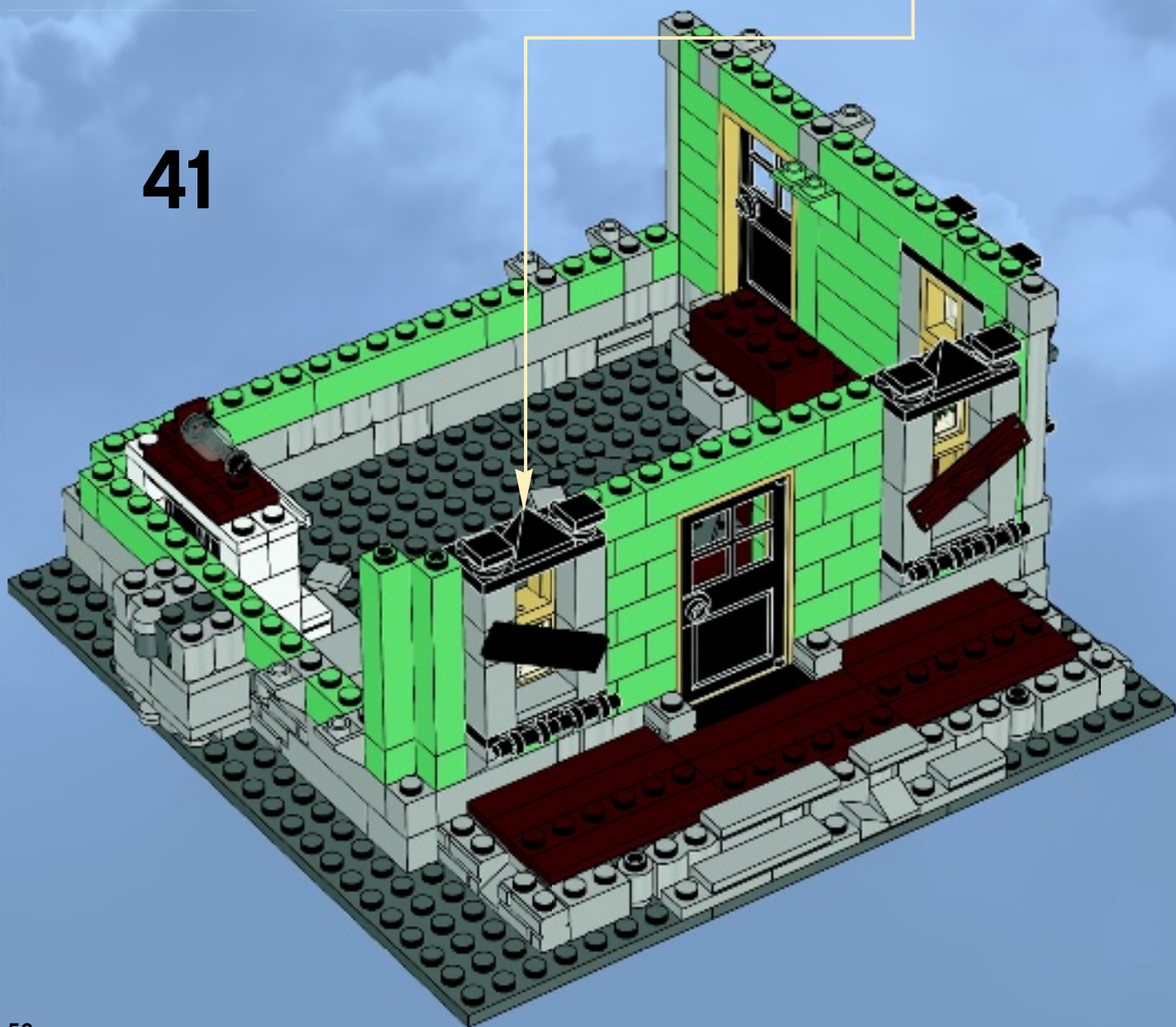



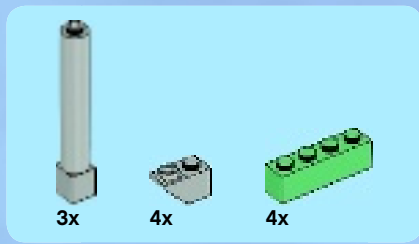

42

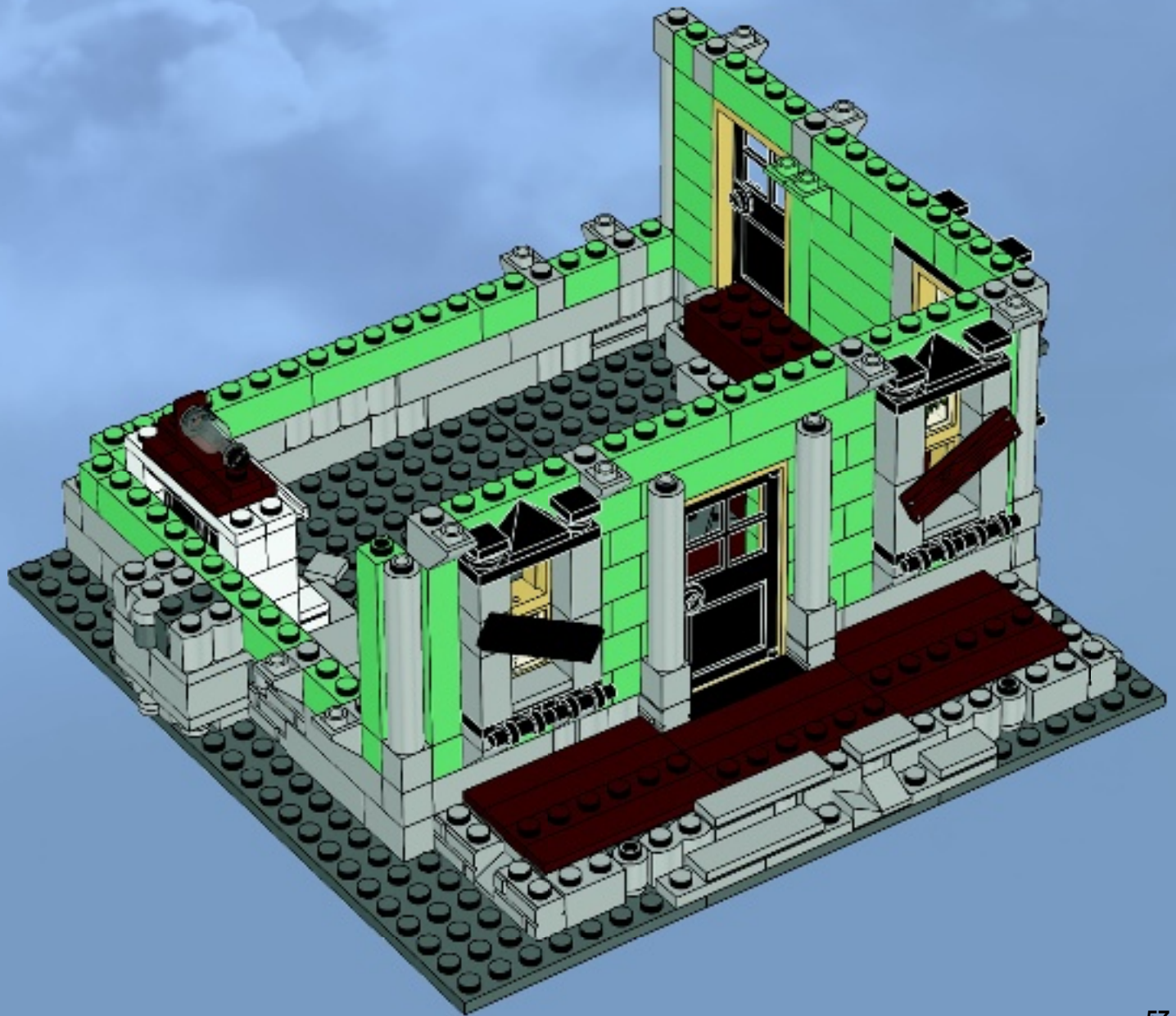



1x

1

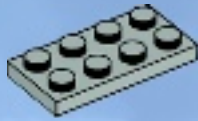

1x



2x

2



1x



2x

3



1x



1x



1x

4

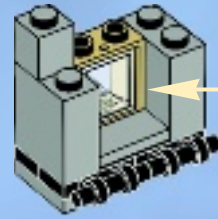

1

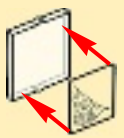

2



1x



1x



1x

5

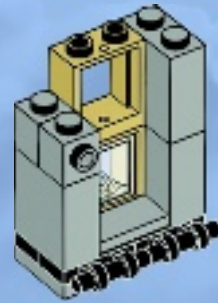

1x



1x

6

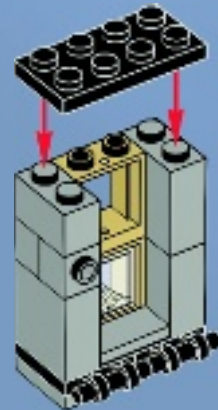



1x



2x

7

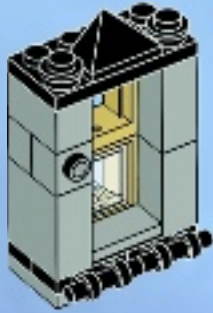

2x



1x

8



43

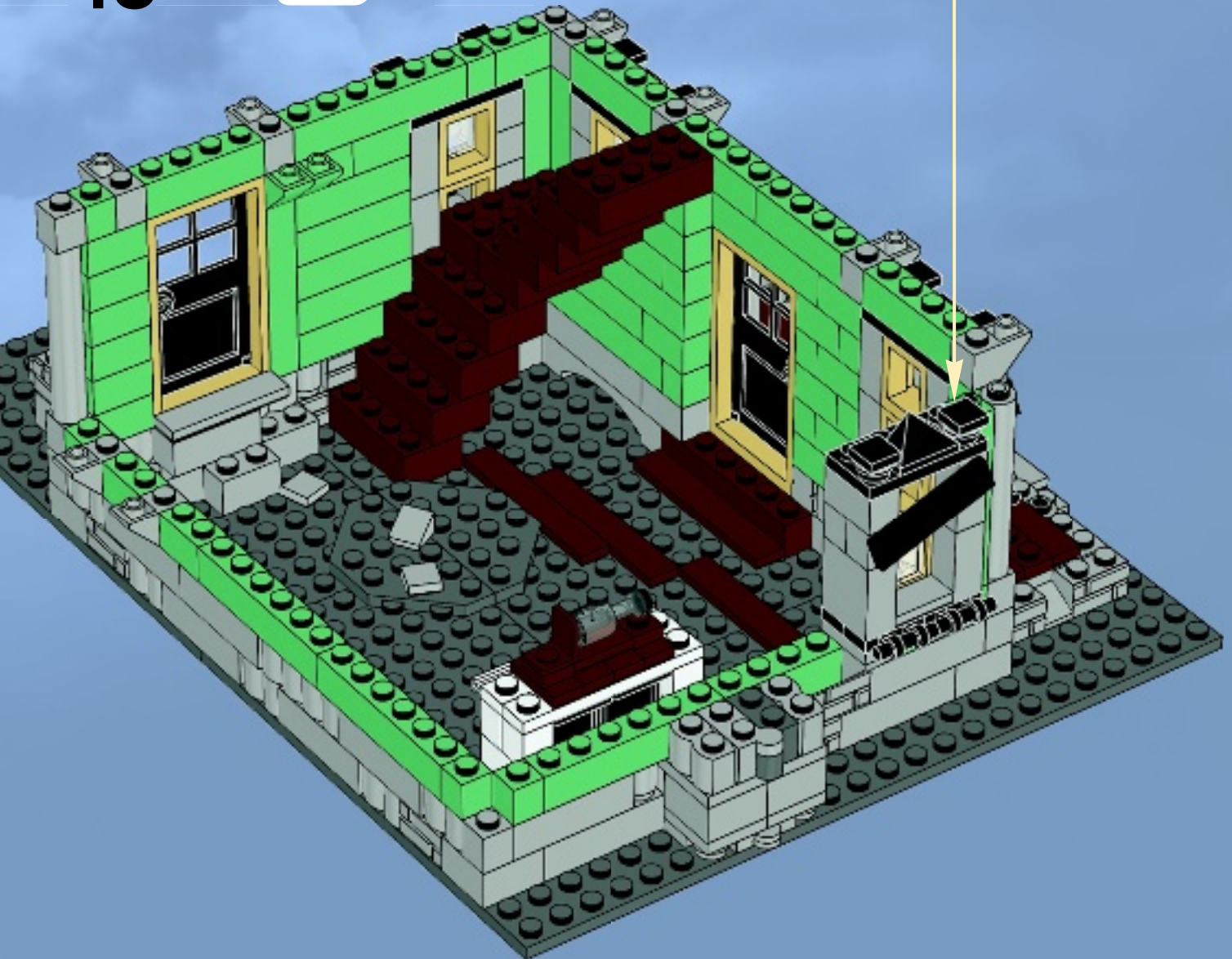



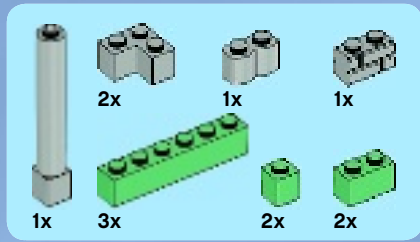

44

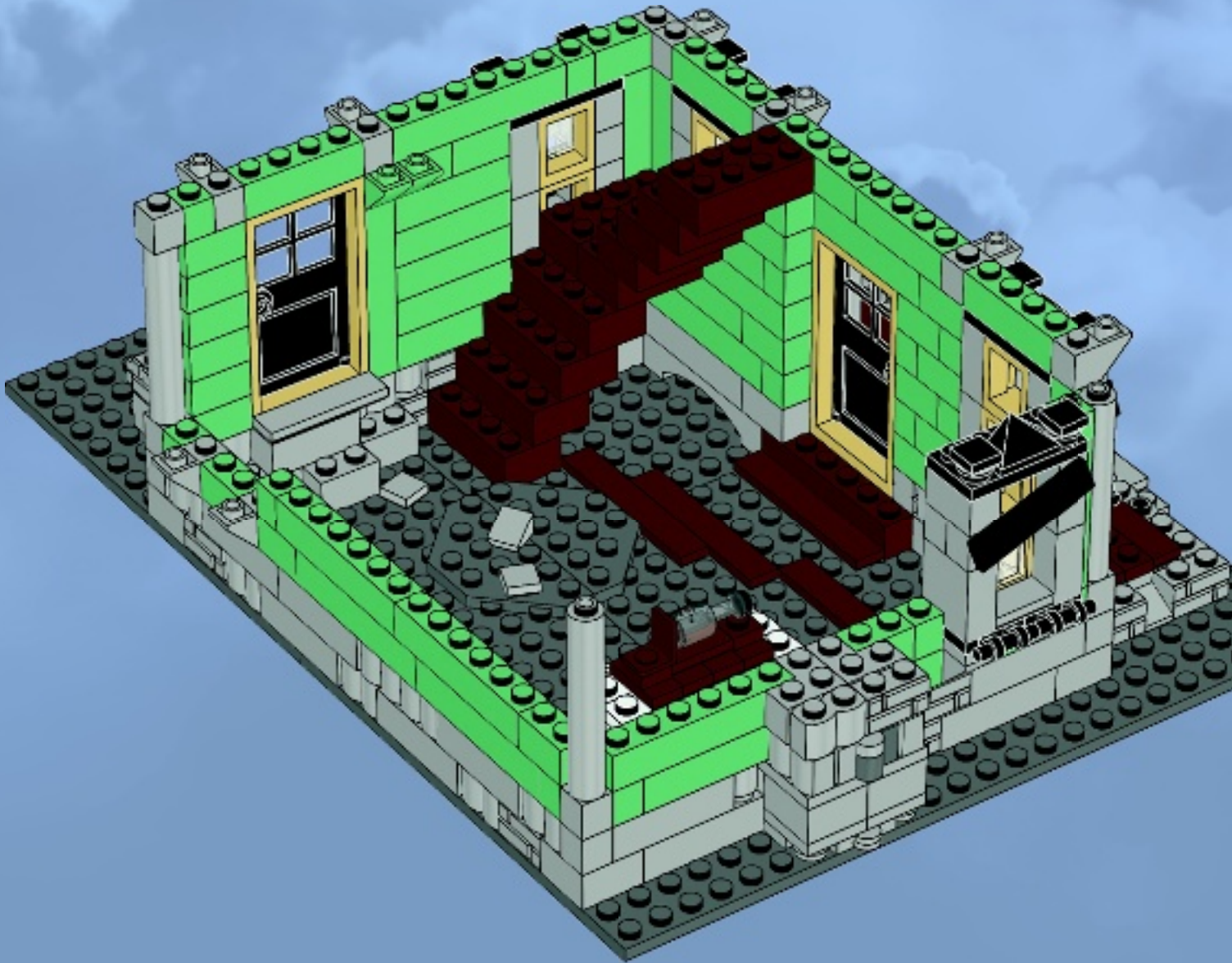

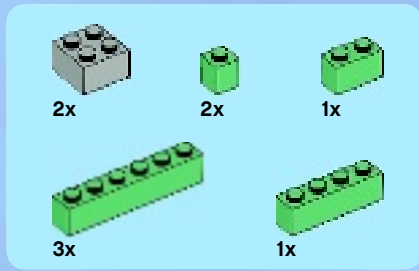

45

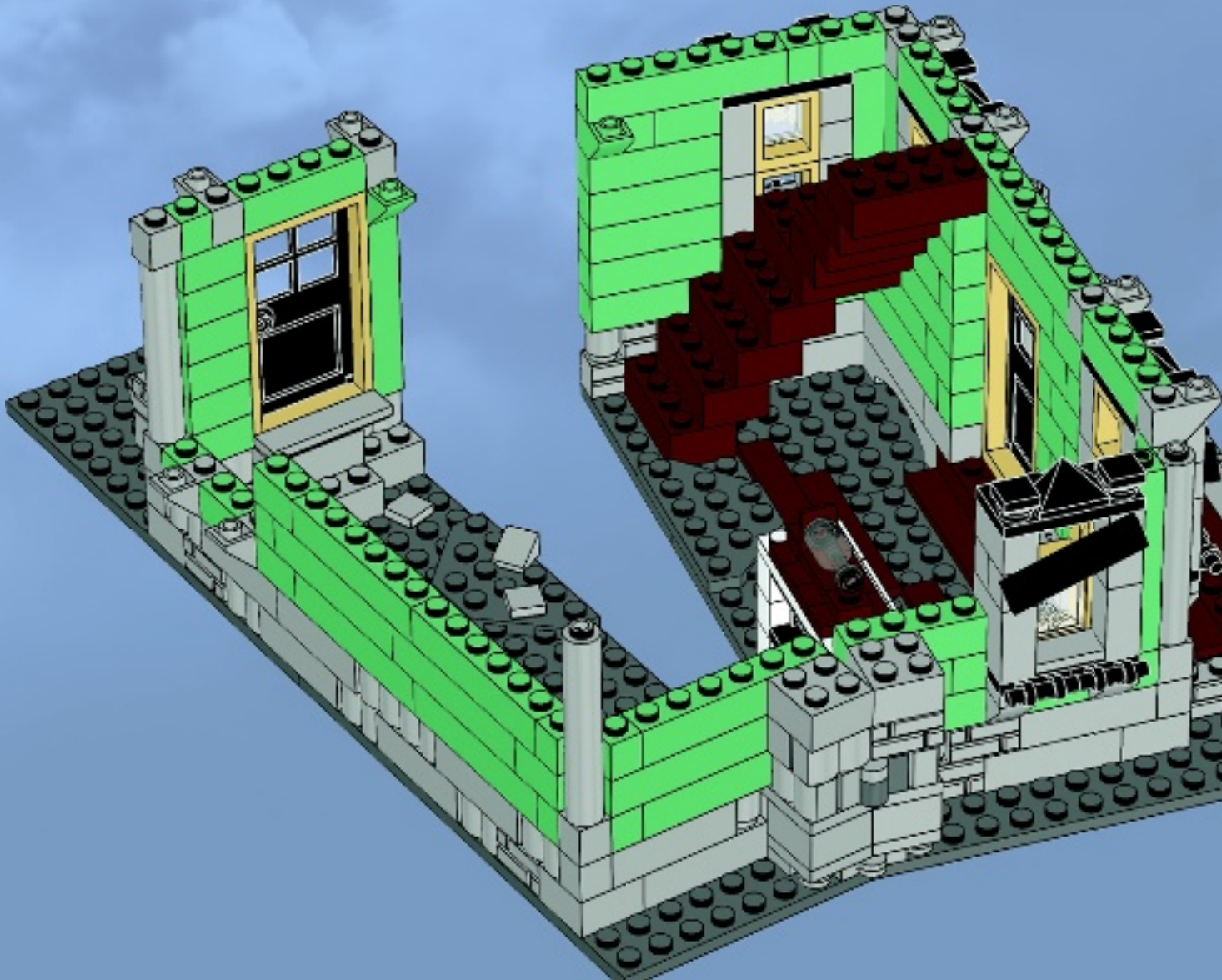



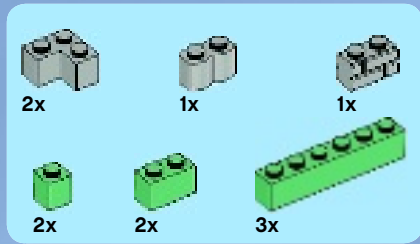

# 46

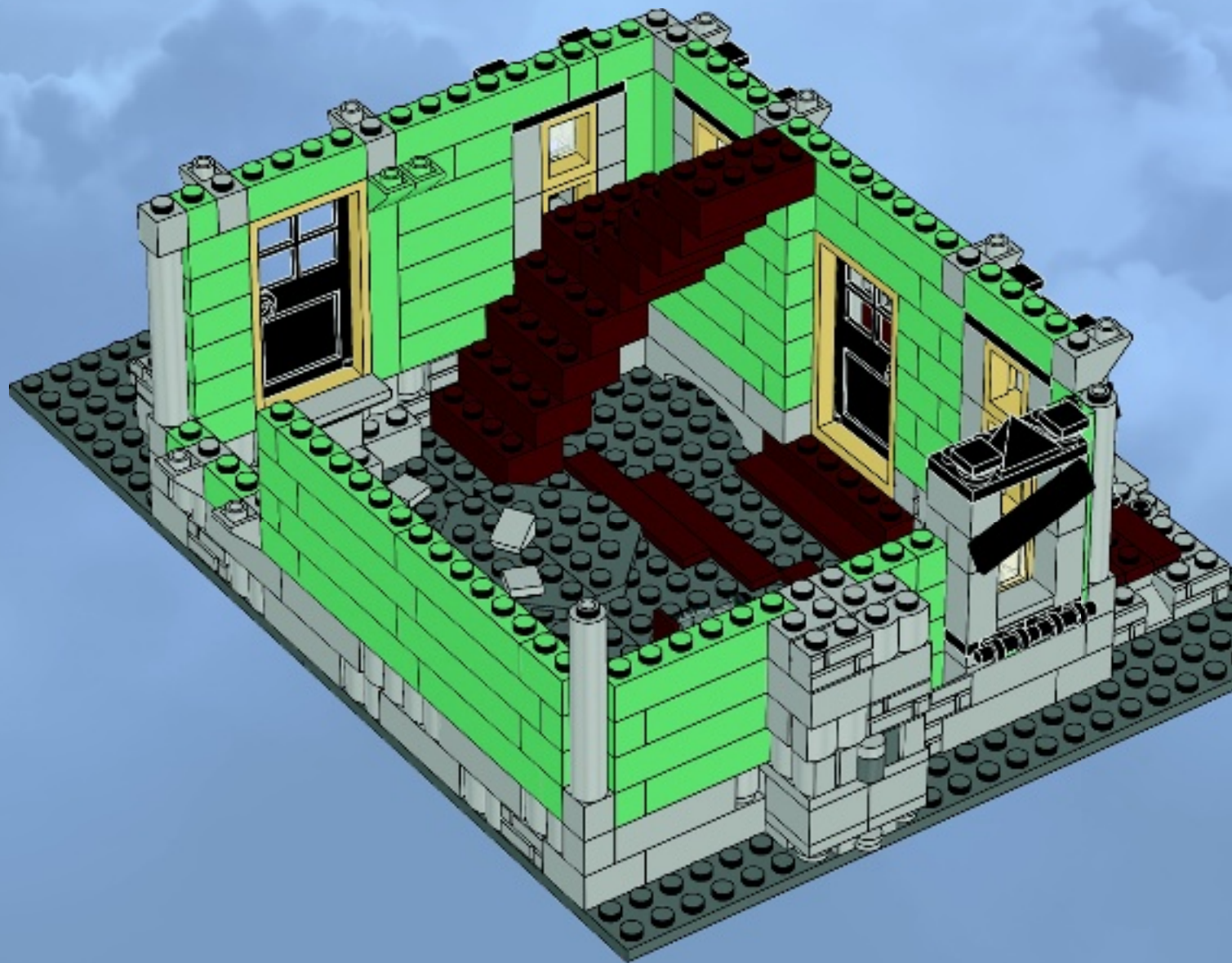



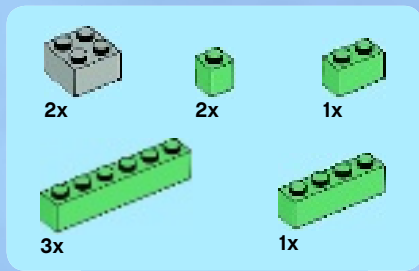

47

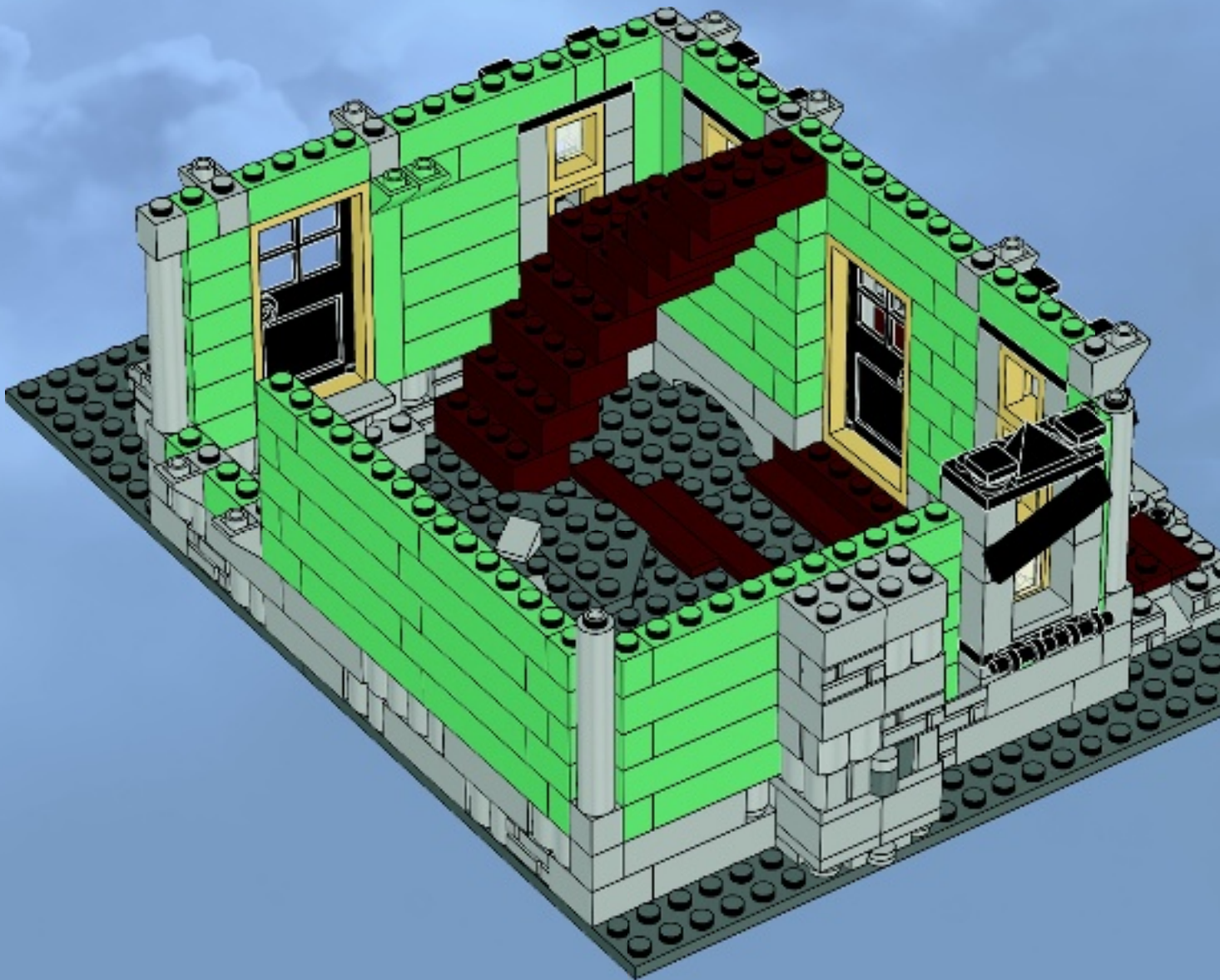

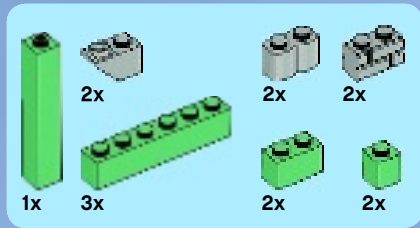

# 48

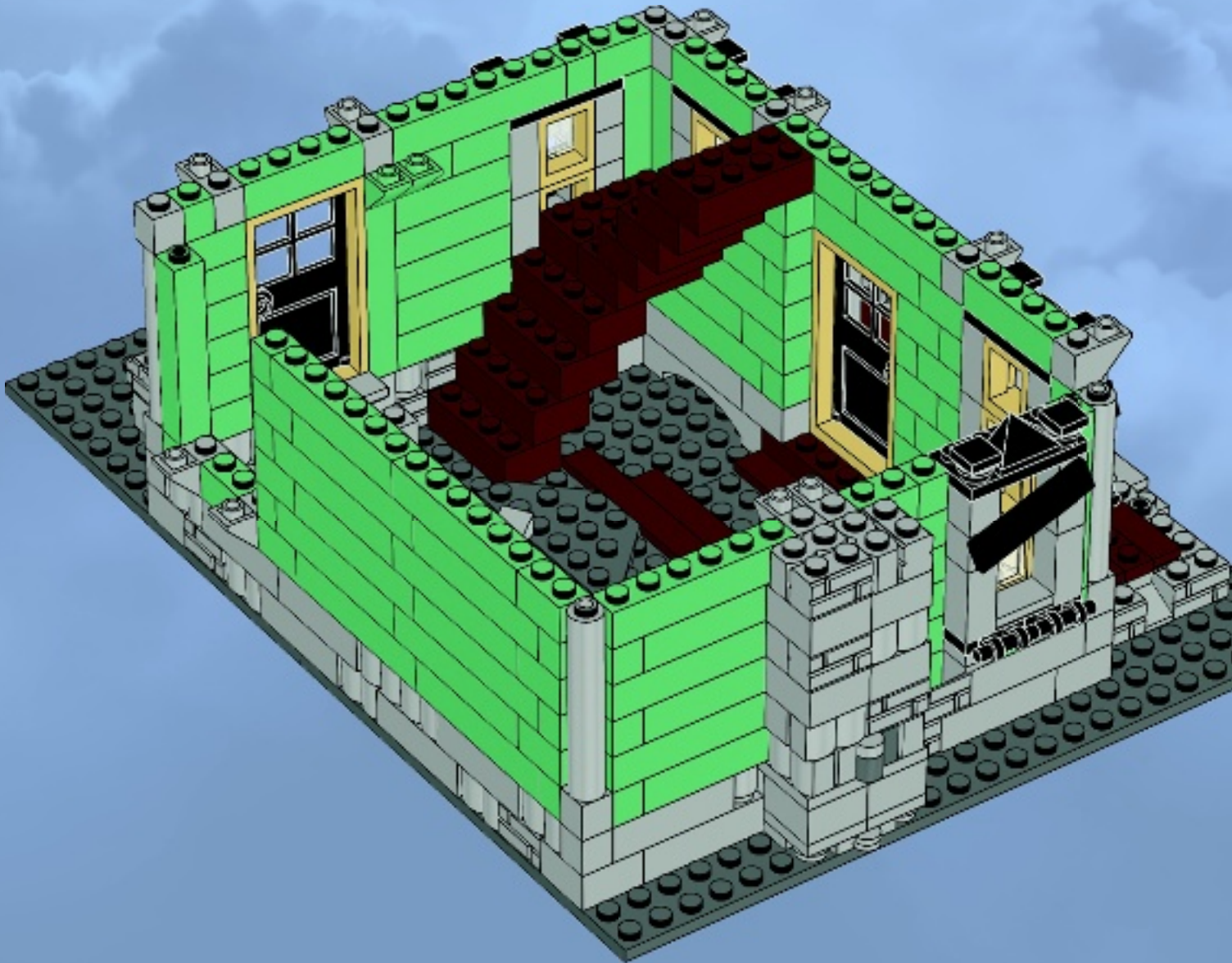



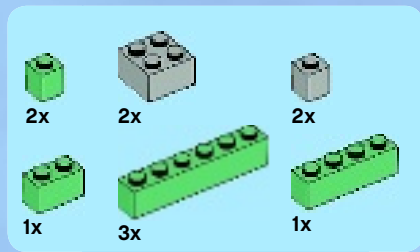

49

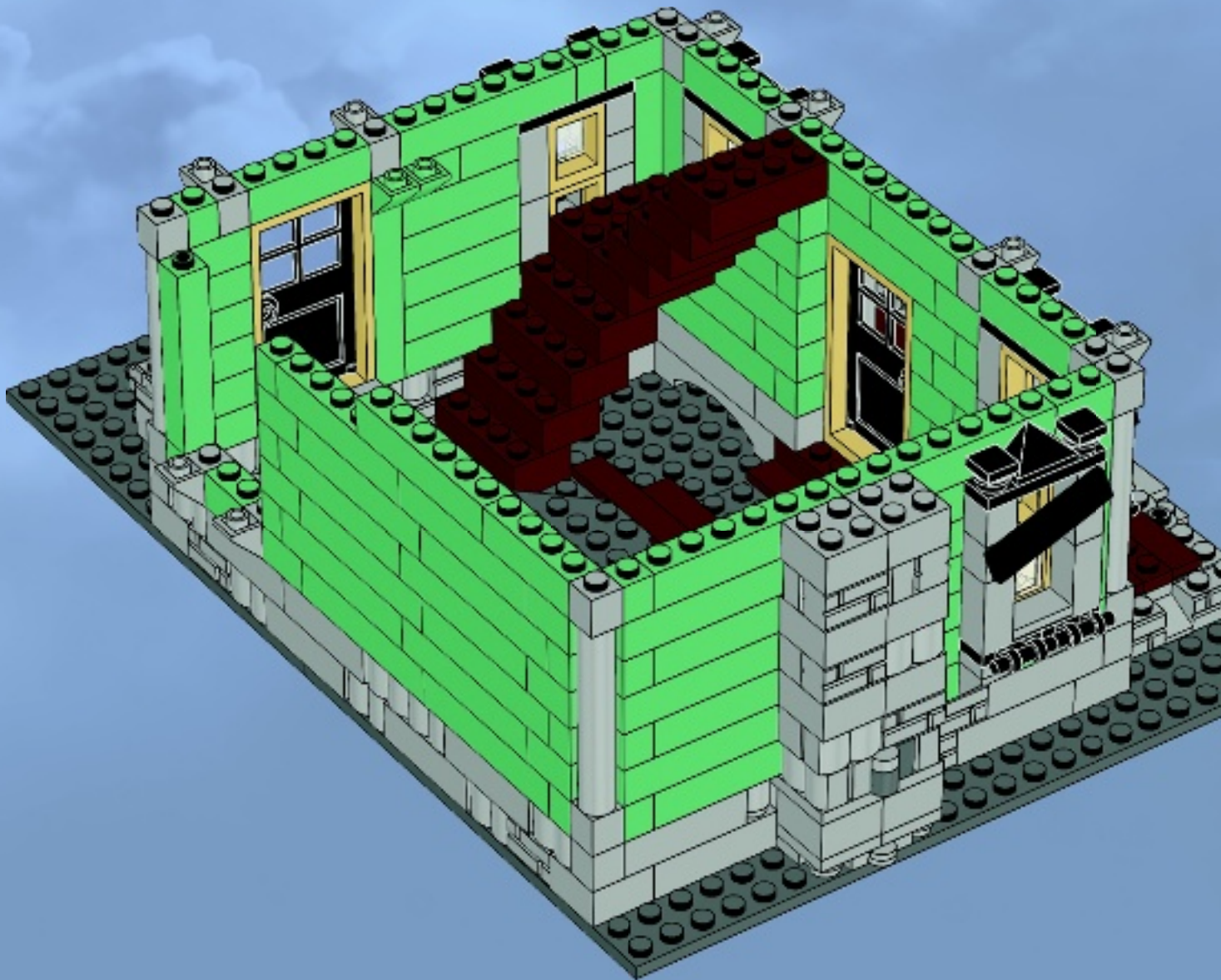





1x

1

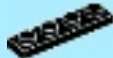
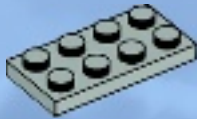

1x



2x

2



1x



2x



1x

3



2x



1x

4

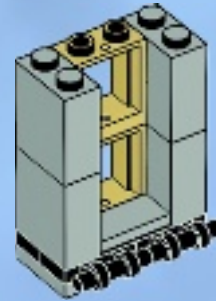

1x

5



1x



2x

6

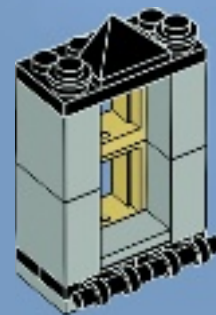

2x

7

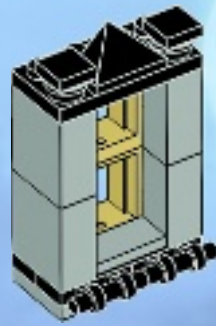

50

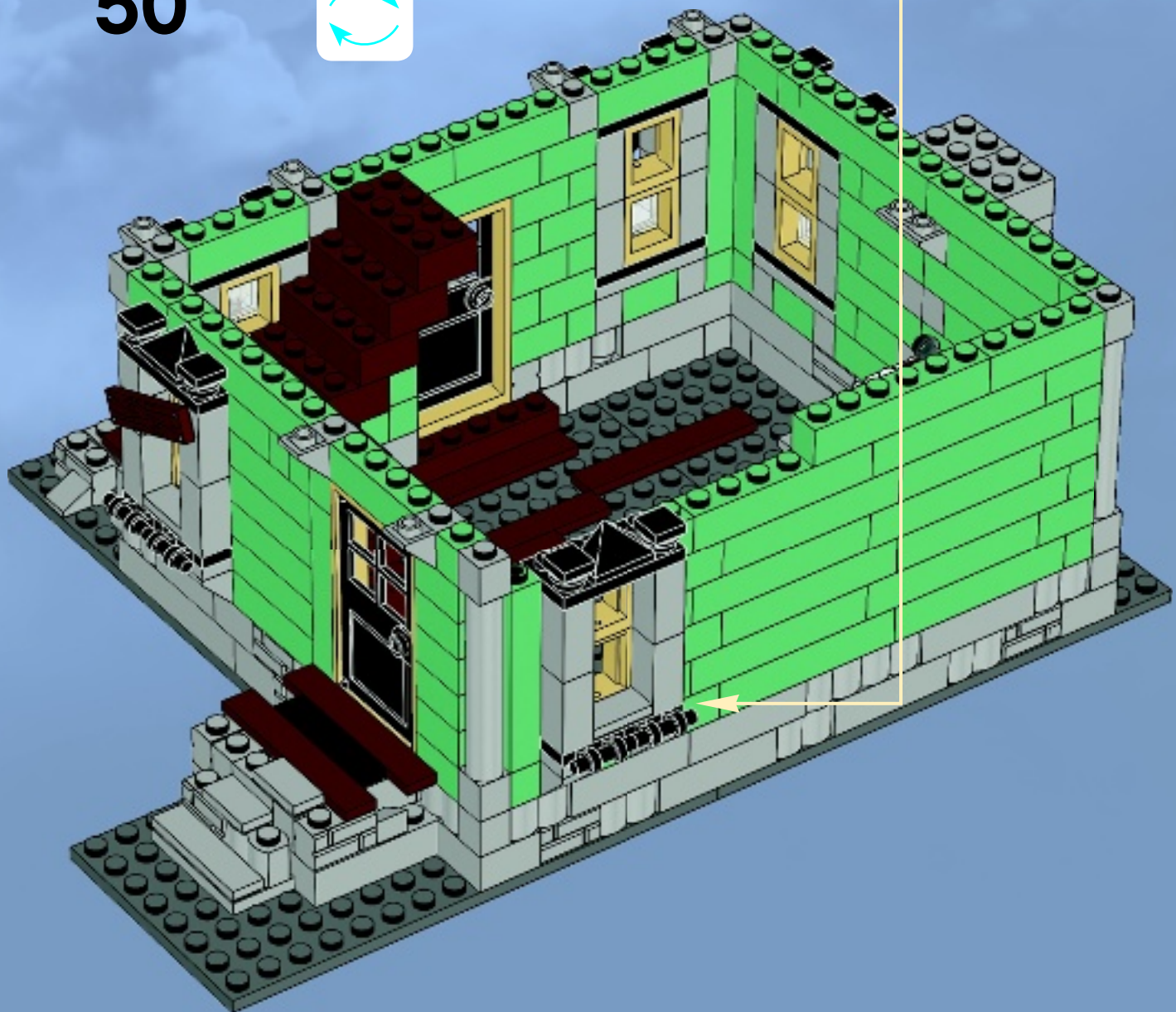



1x



1x

# 51

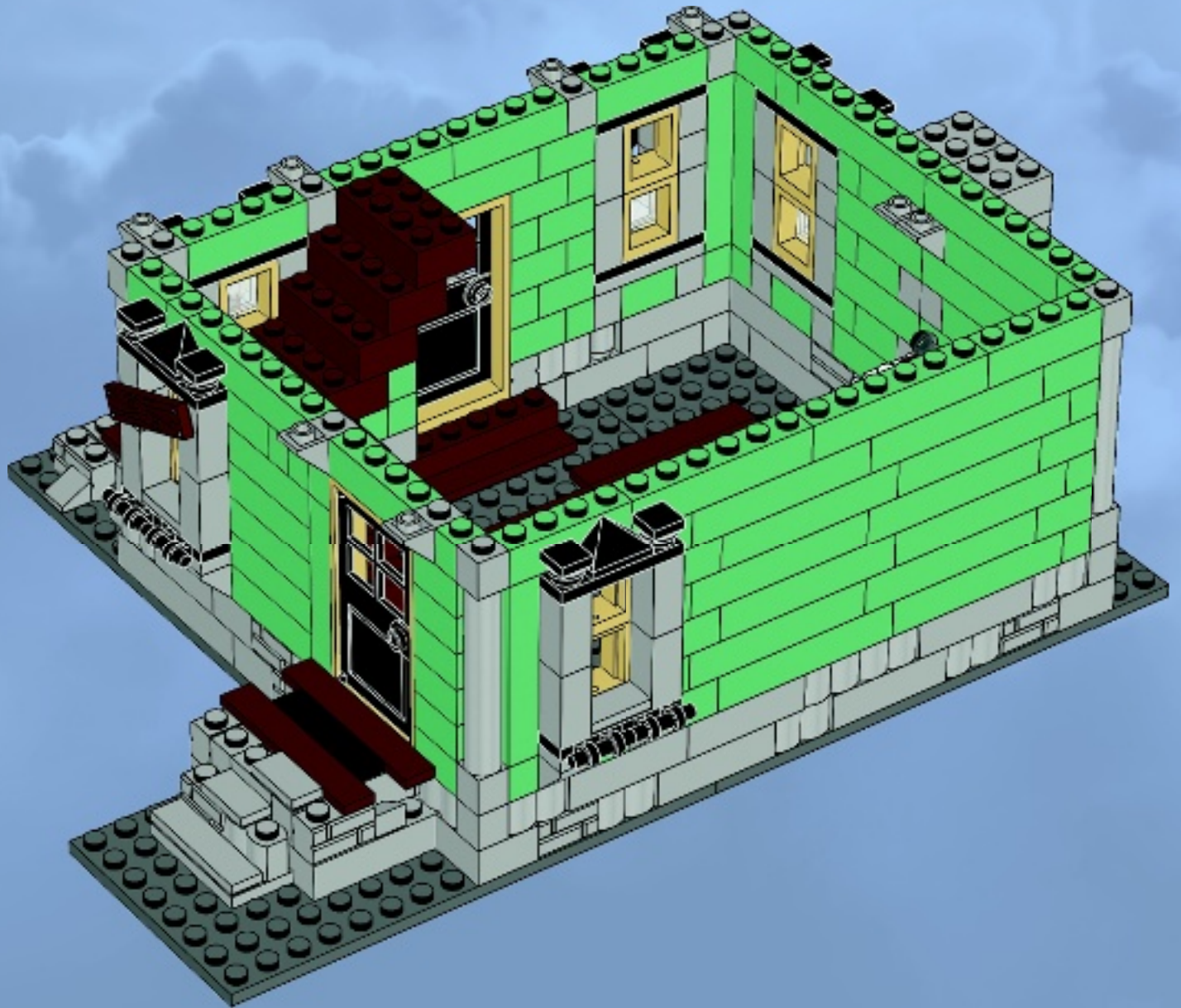



52

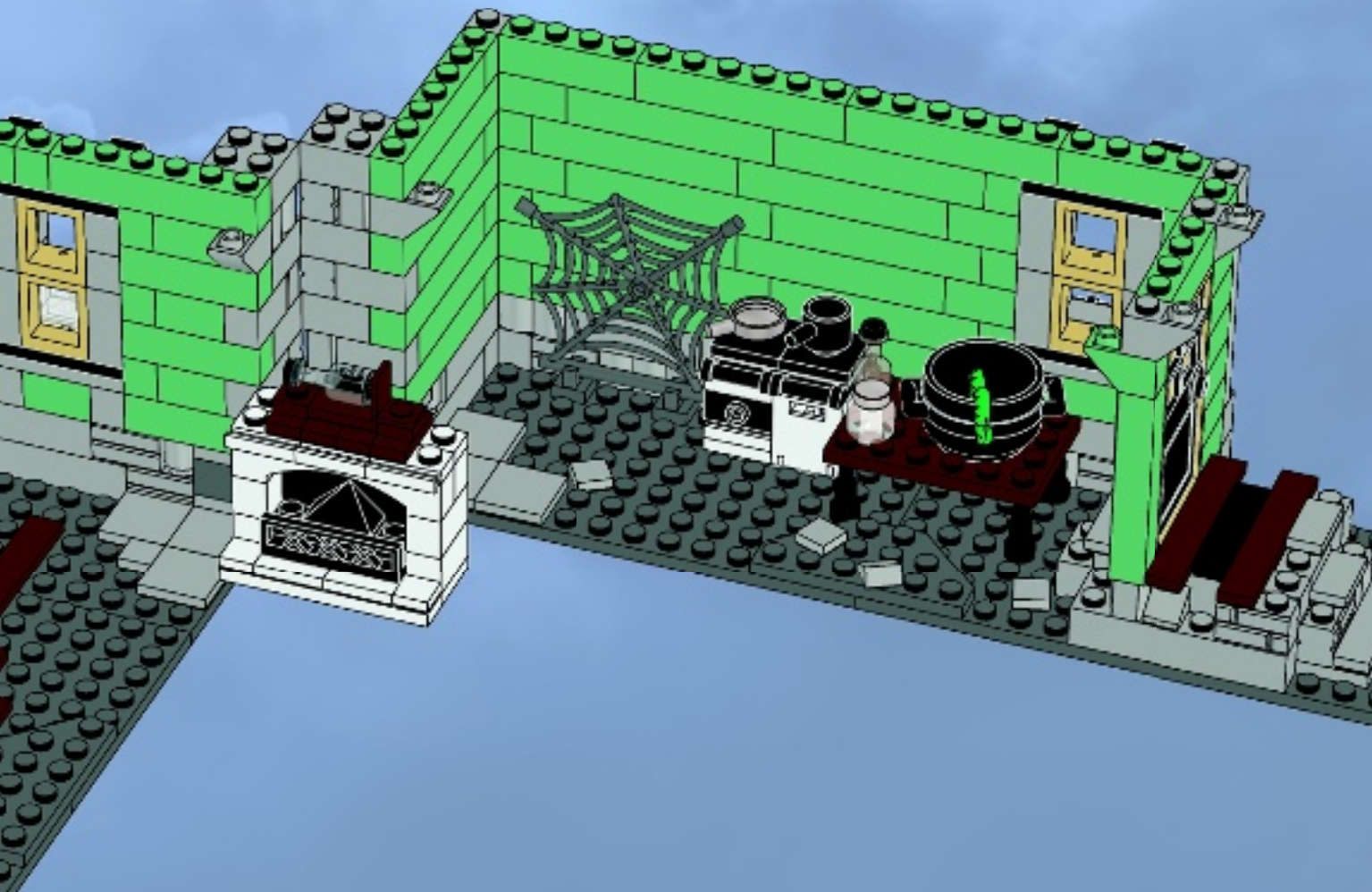

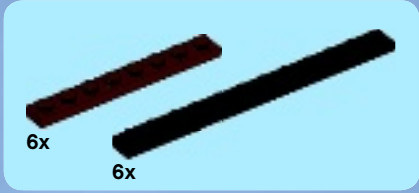

1

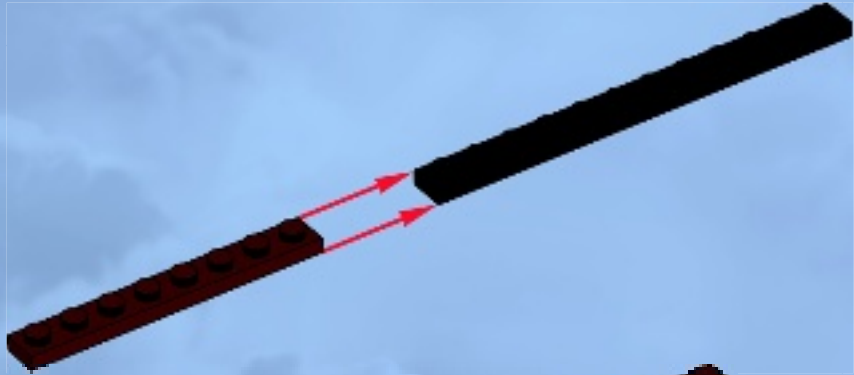

2



3



2x

53

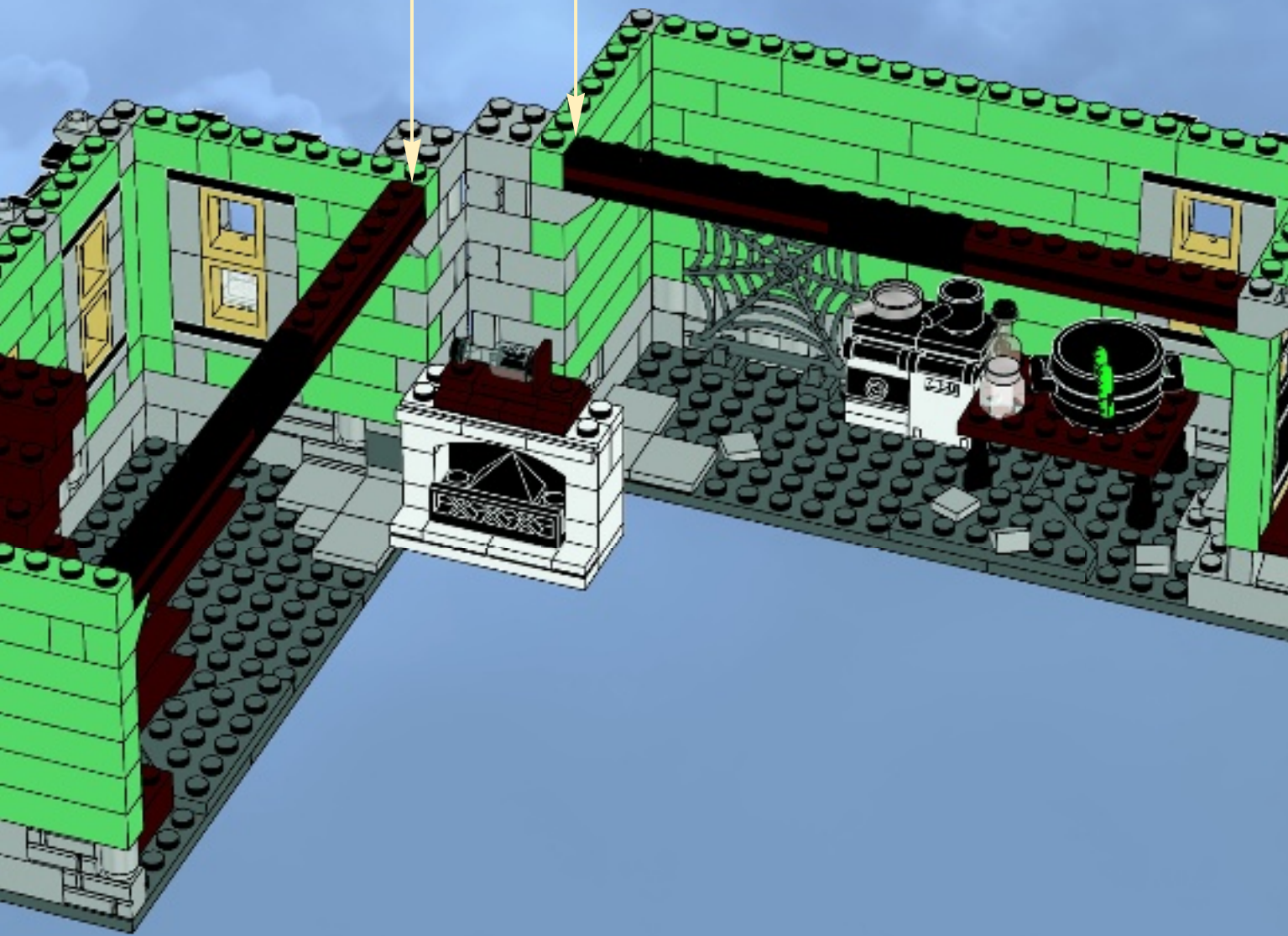



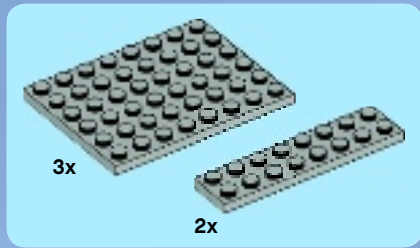

54

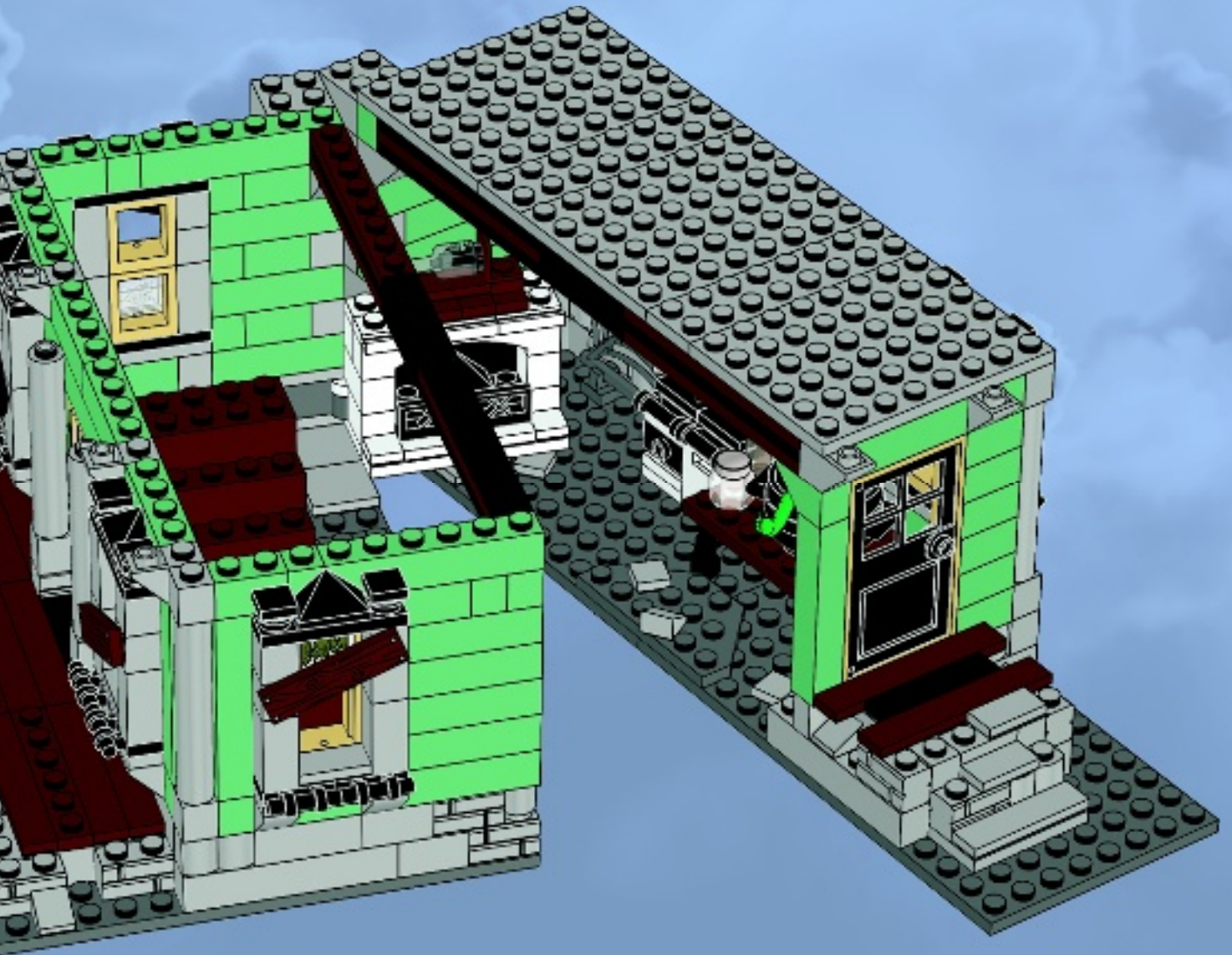

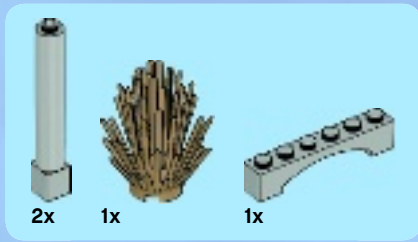

55

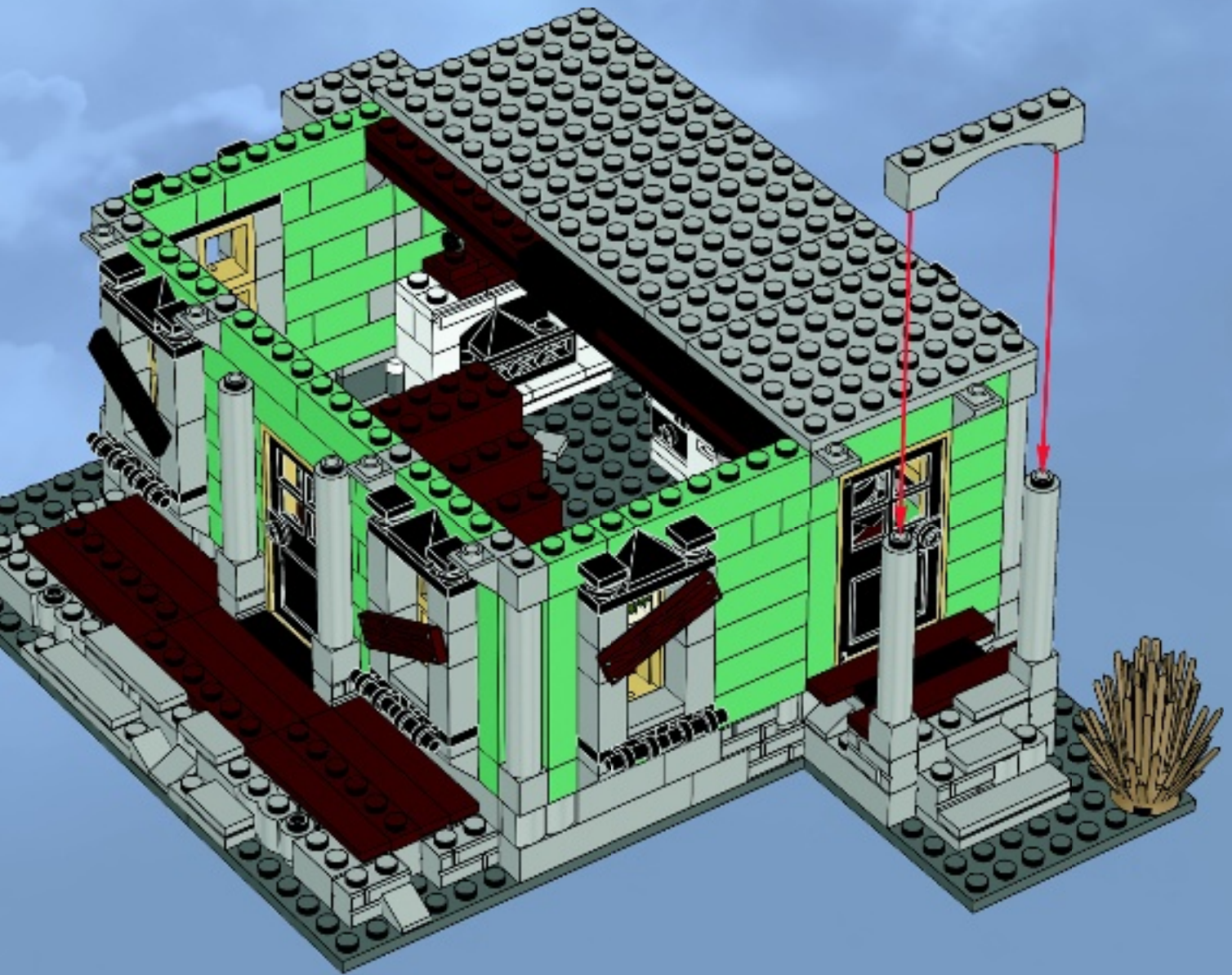



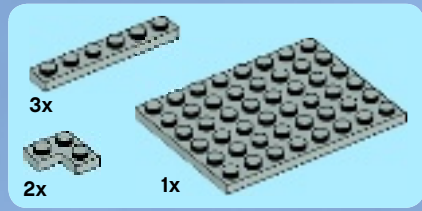

# 56

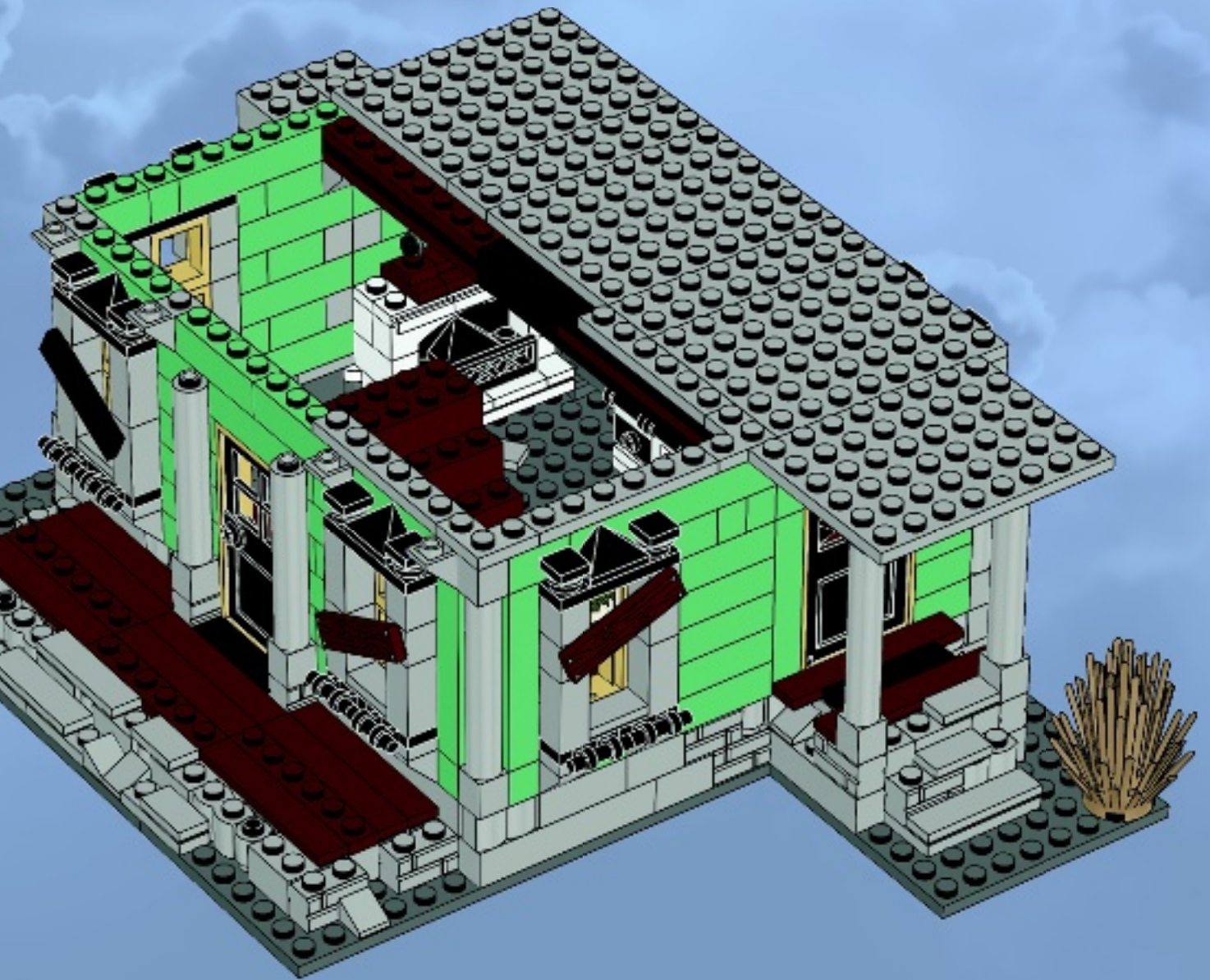



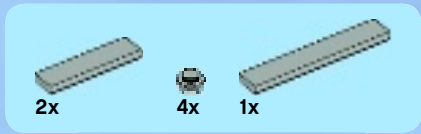

57

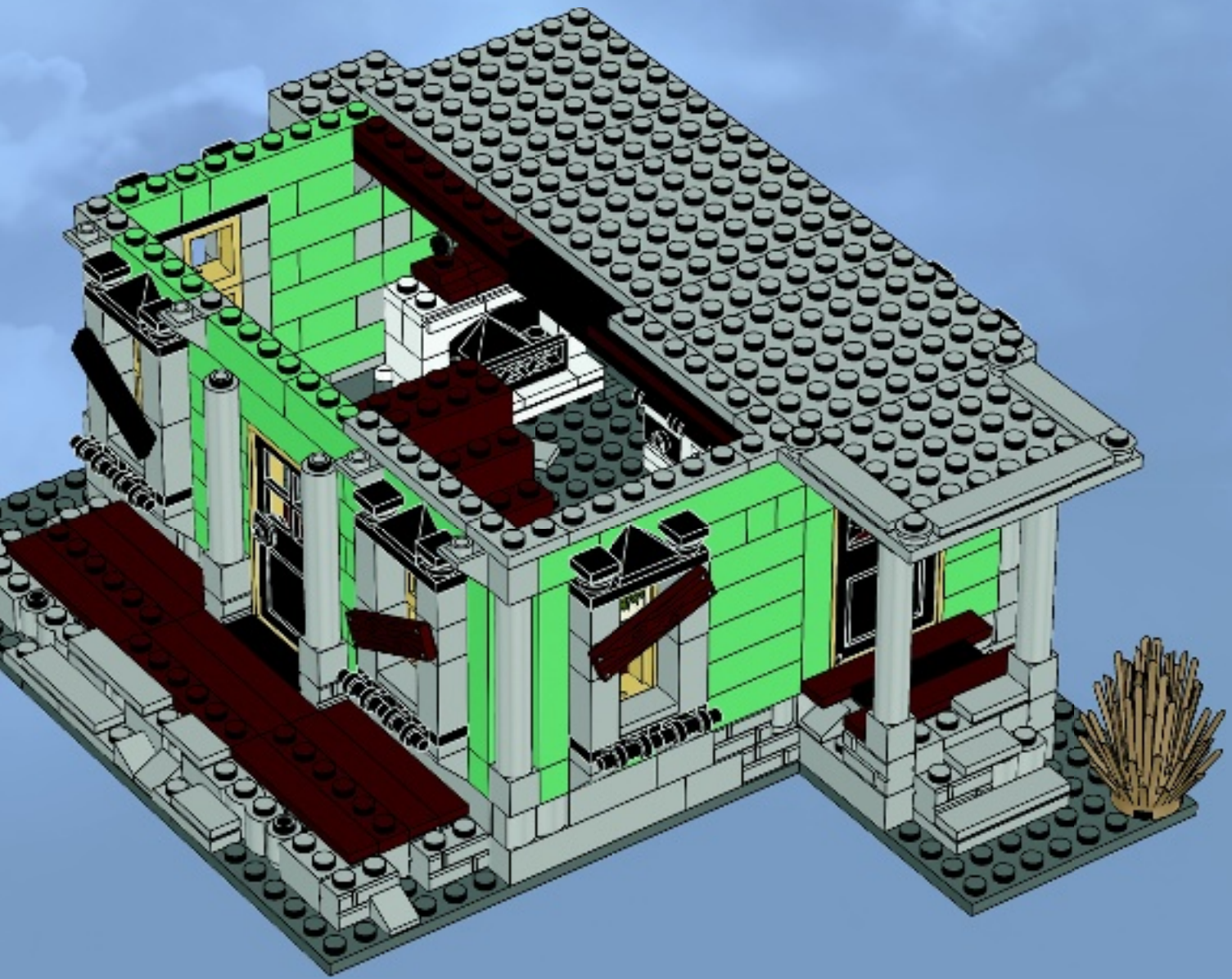

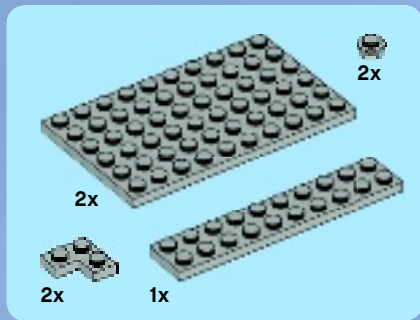

58

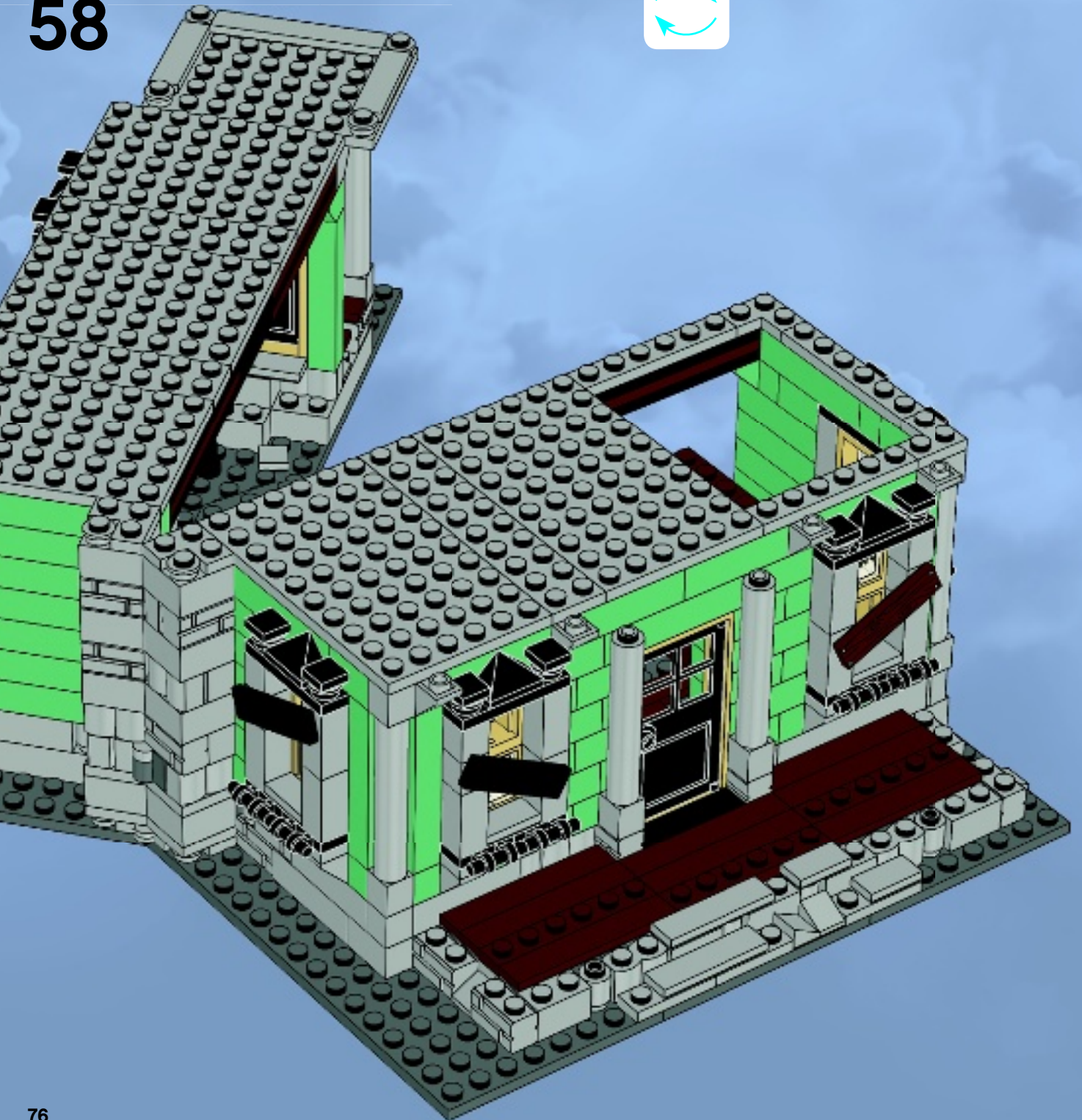





4x



4x

# 59

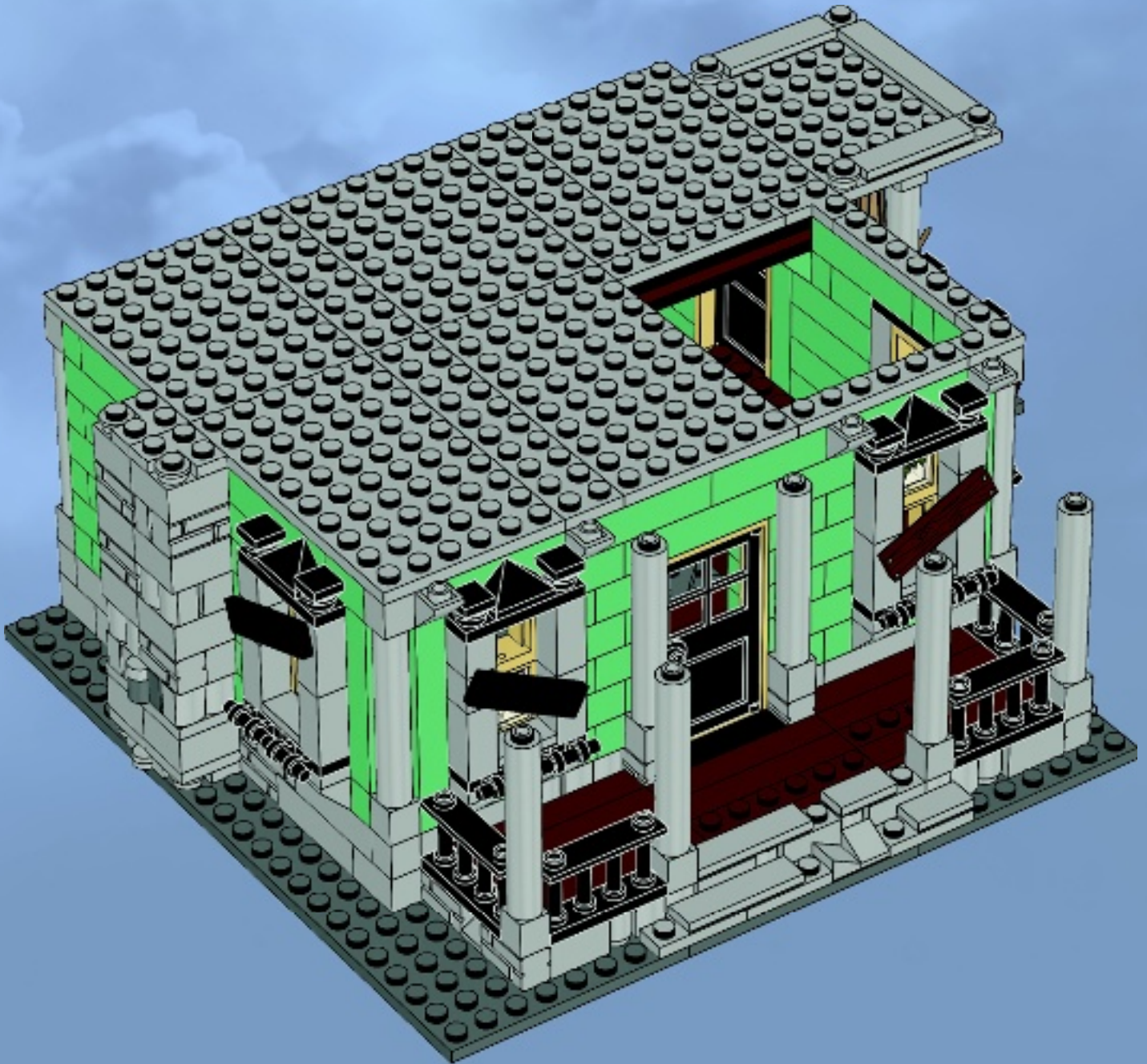



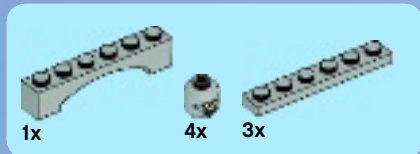

60

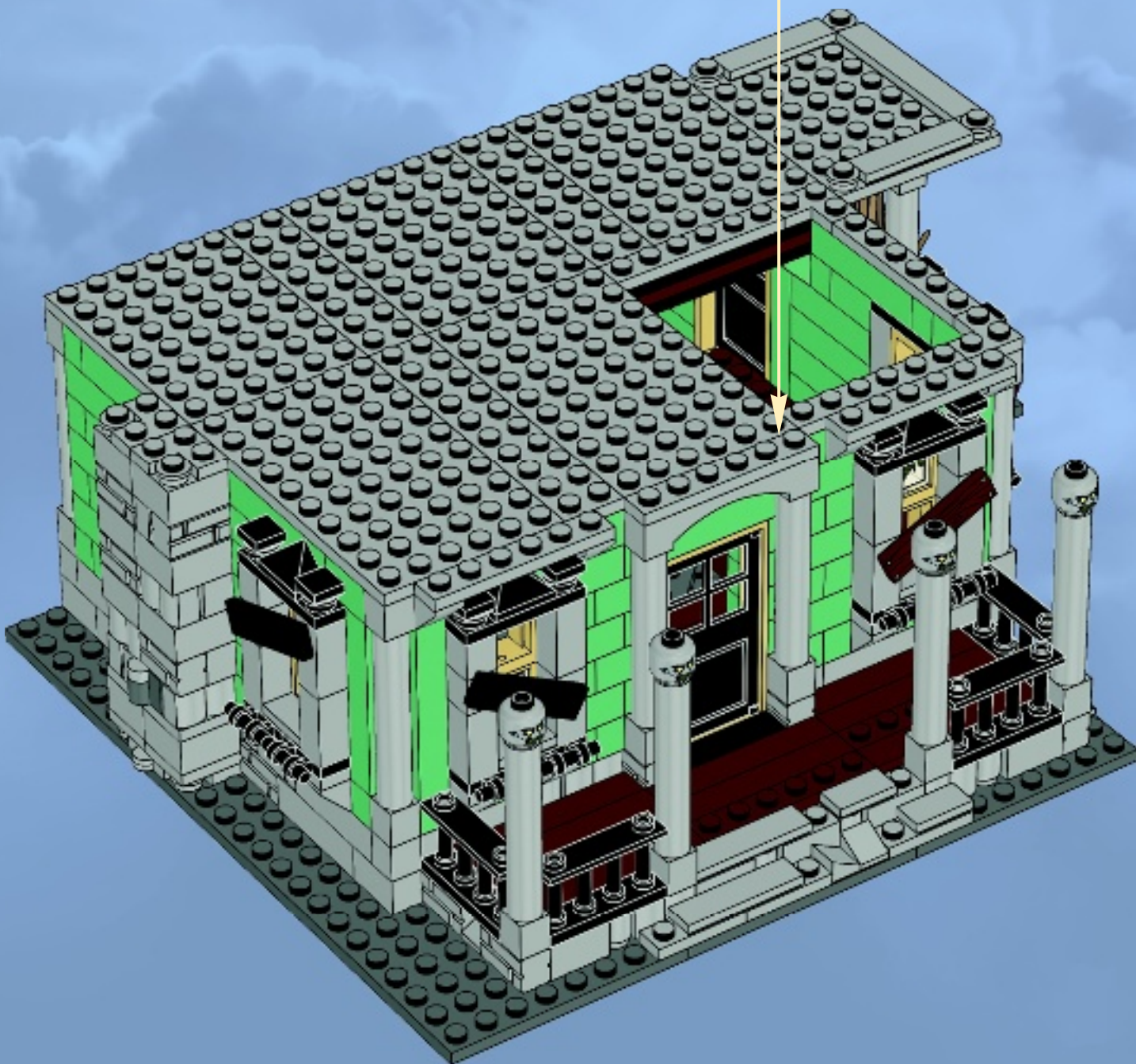
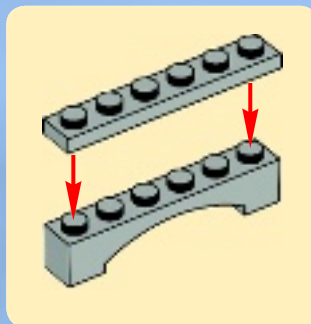





2x



4x



2x



2x

# 61

1

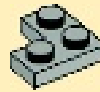

2

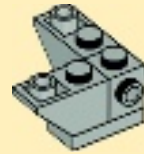

3

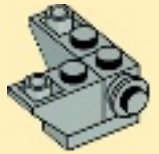

1



2

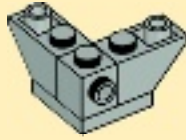

3

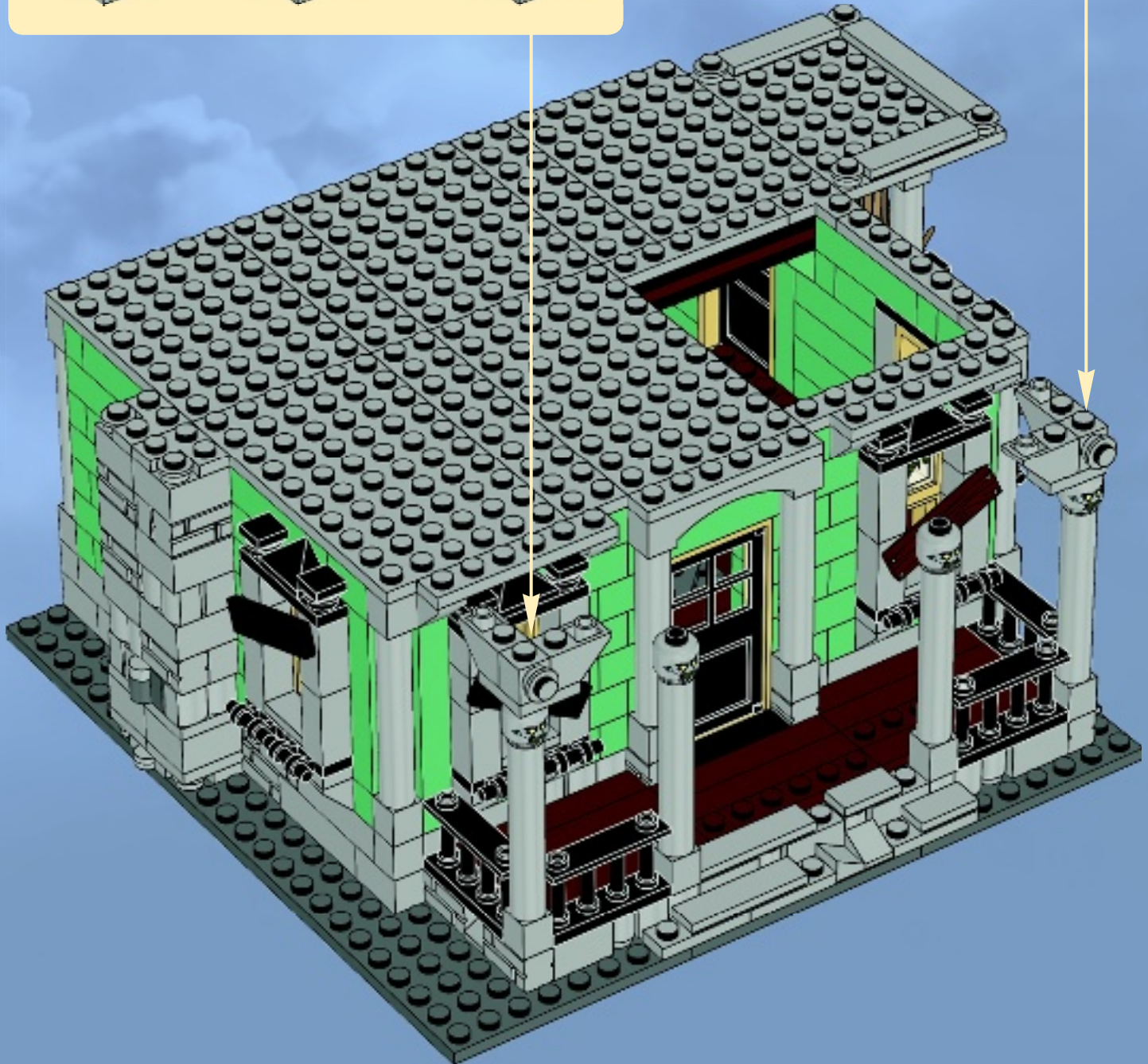
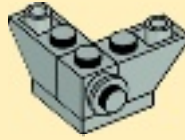



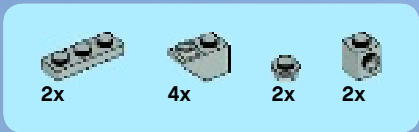

62

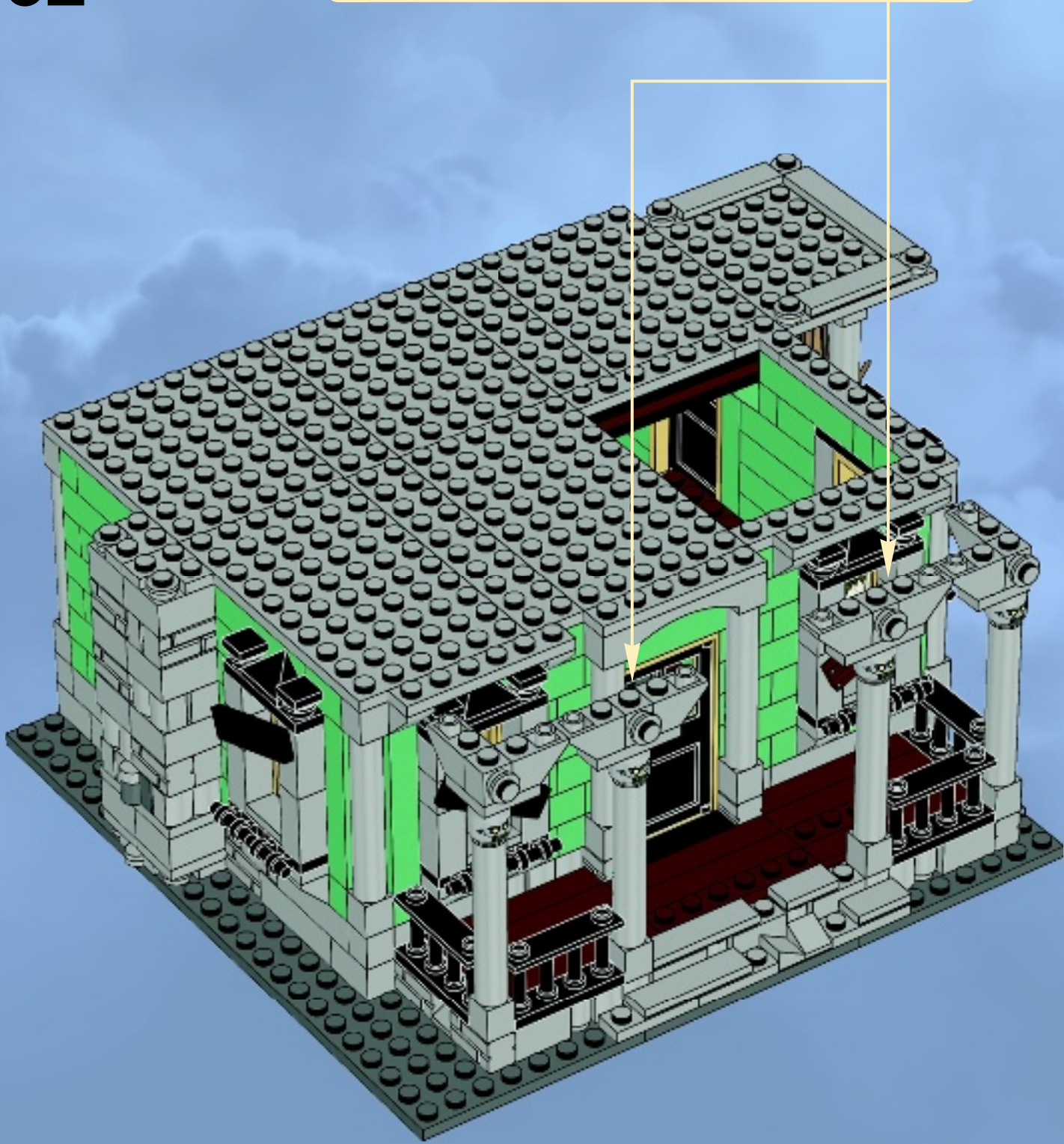
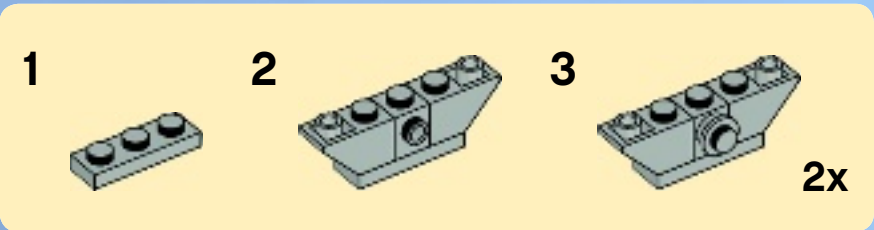



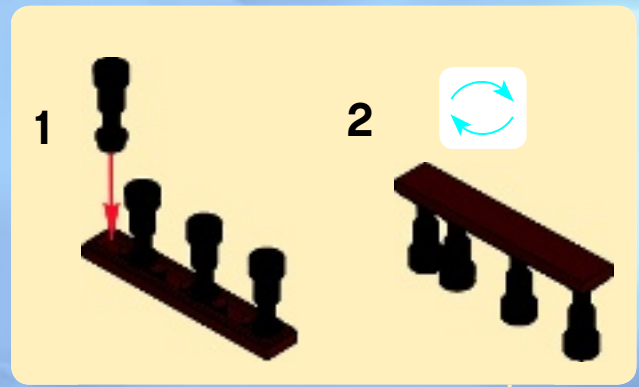
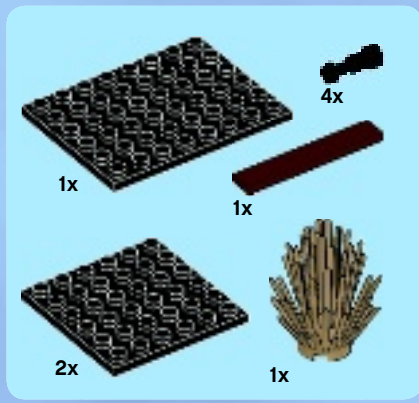

63

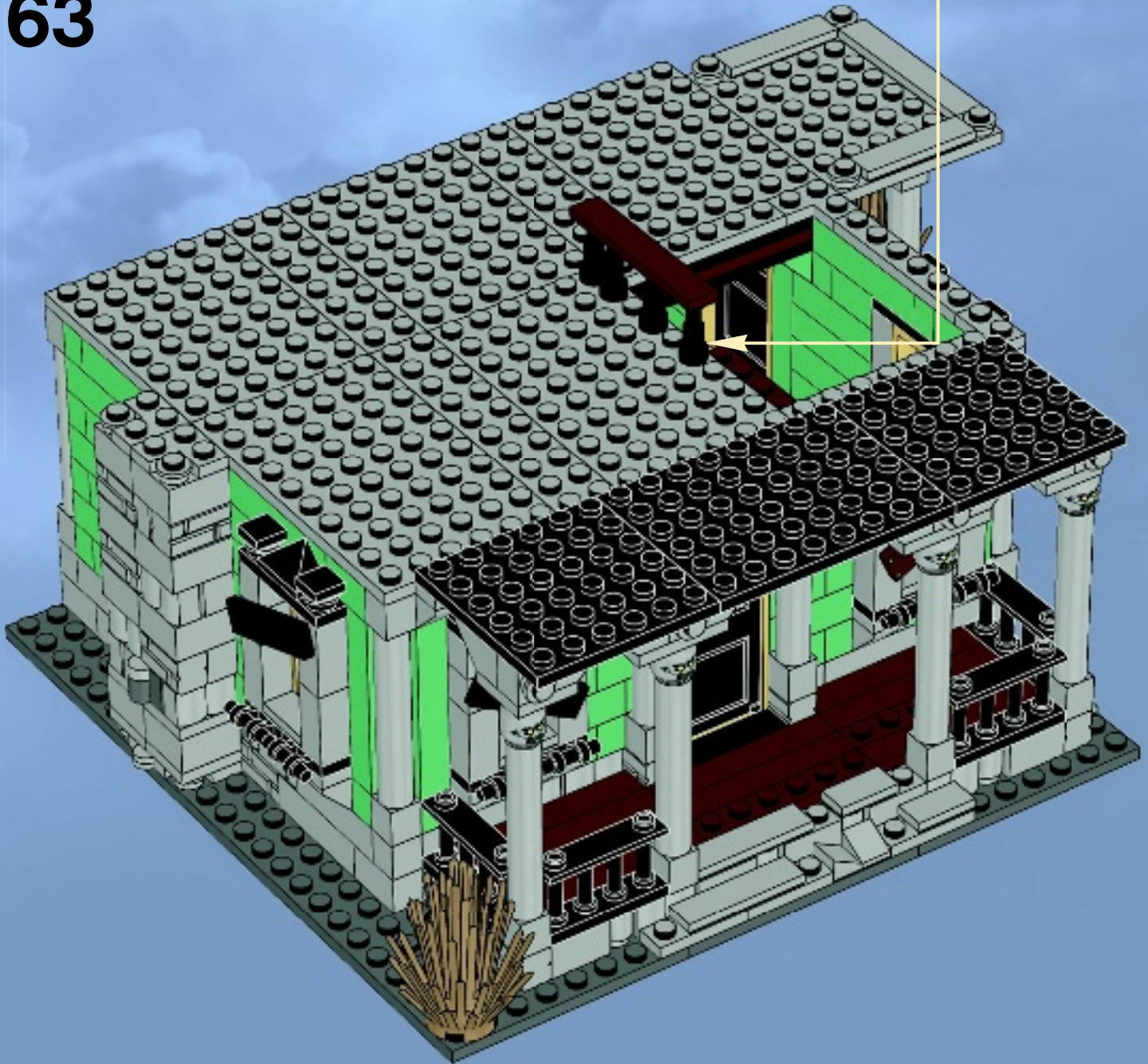





10x



6x

# 64

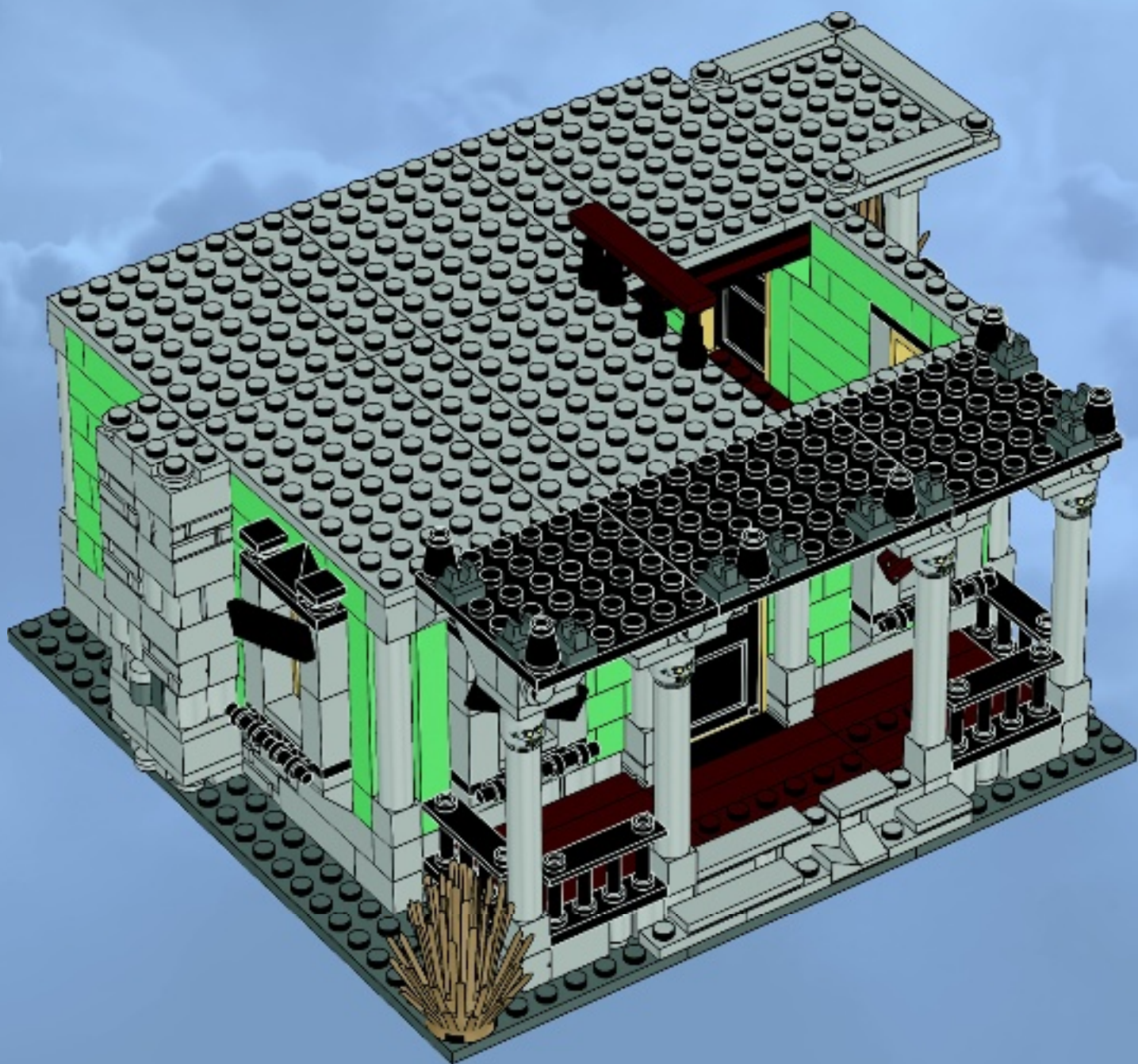



6x



3x



2x

# 65

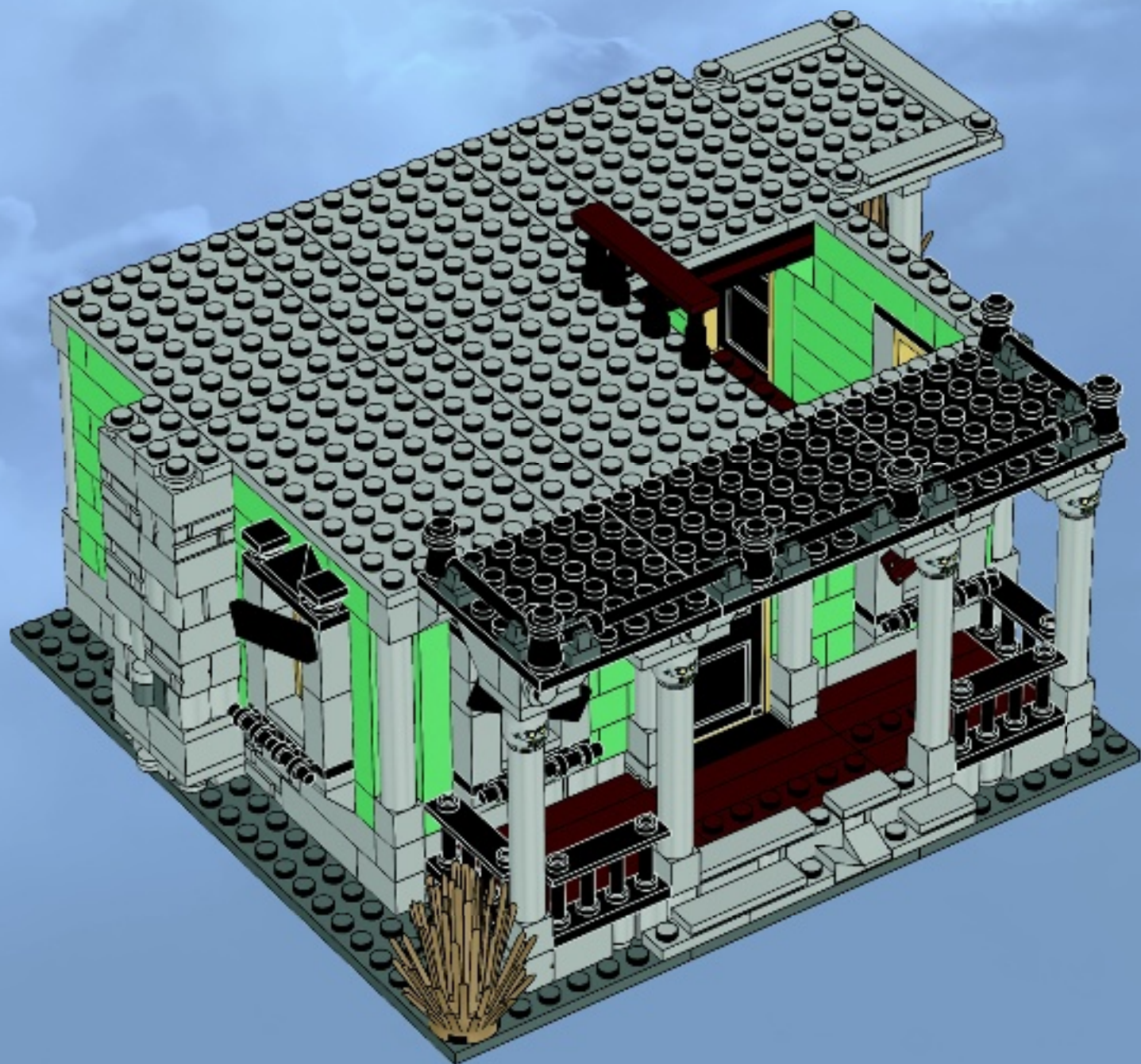





12x

# 66

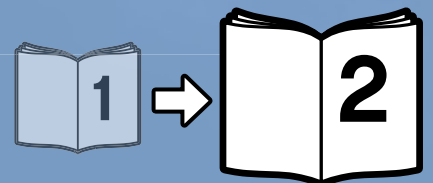

6015220 / 6015221



[www.LEGO.com](http://www.LEGO.com)





# MONSTER FIGHTERS

10228





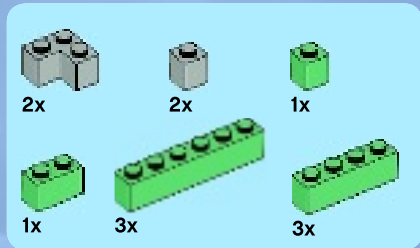
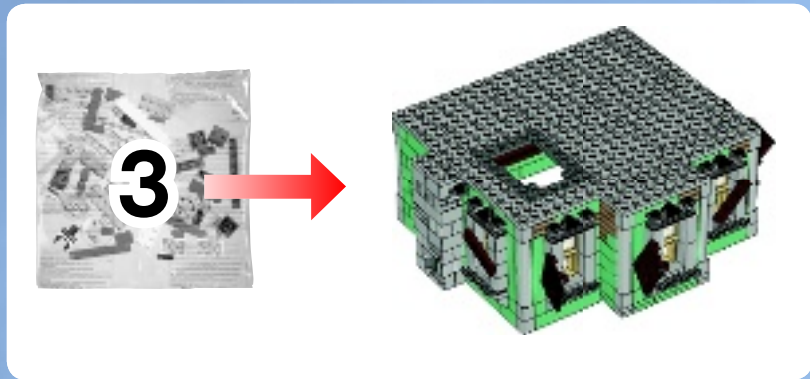

67

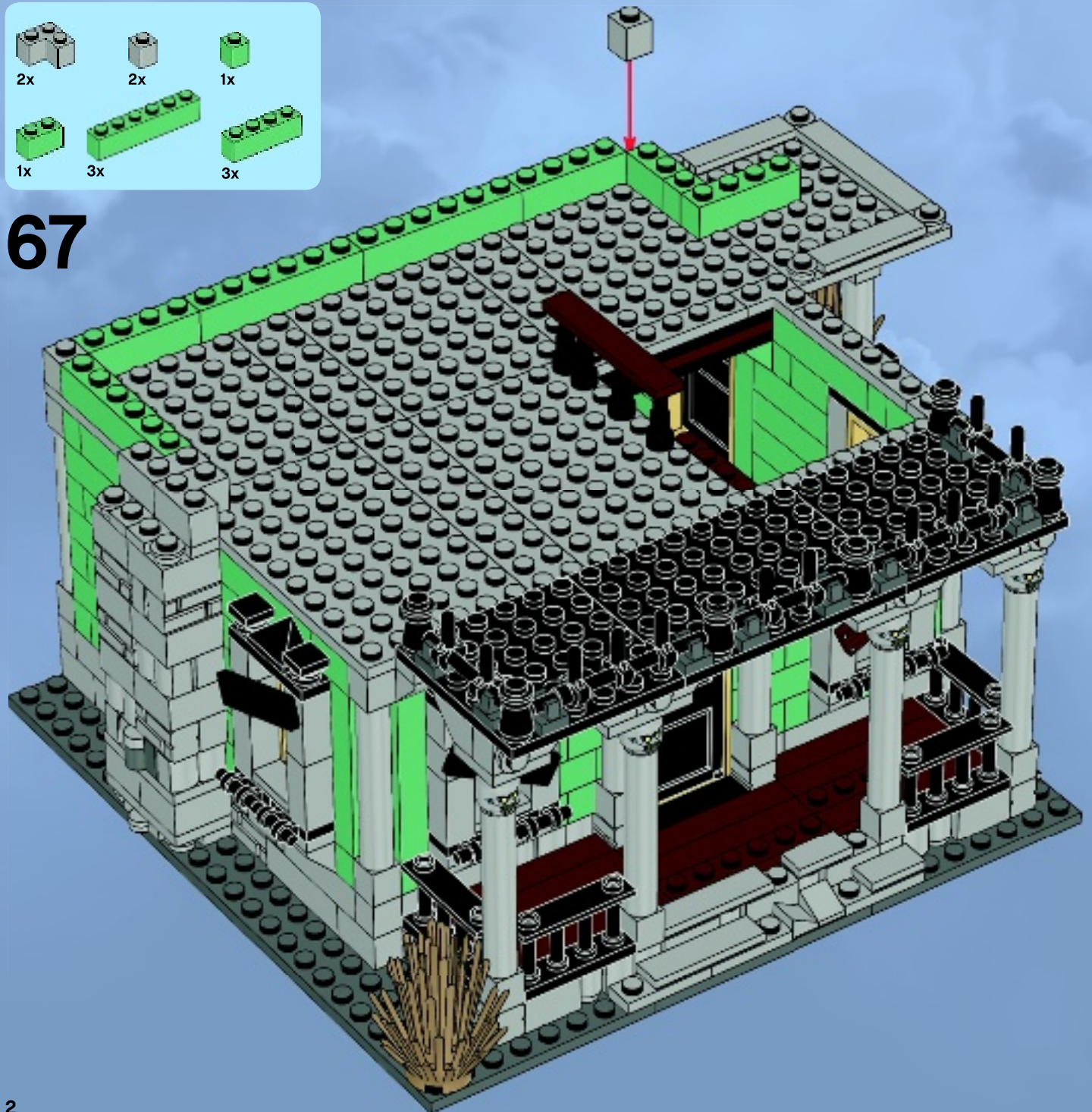



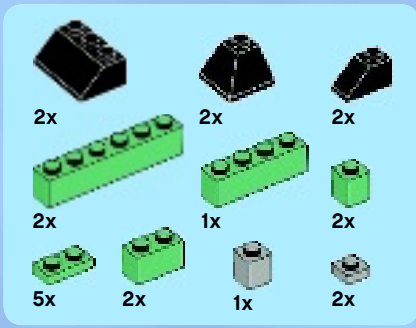

# 68

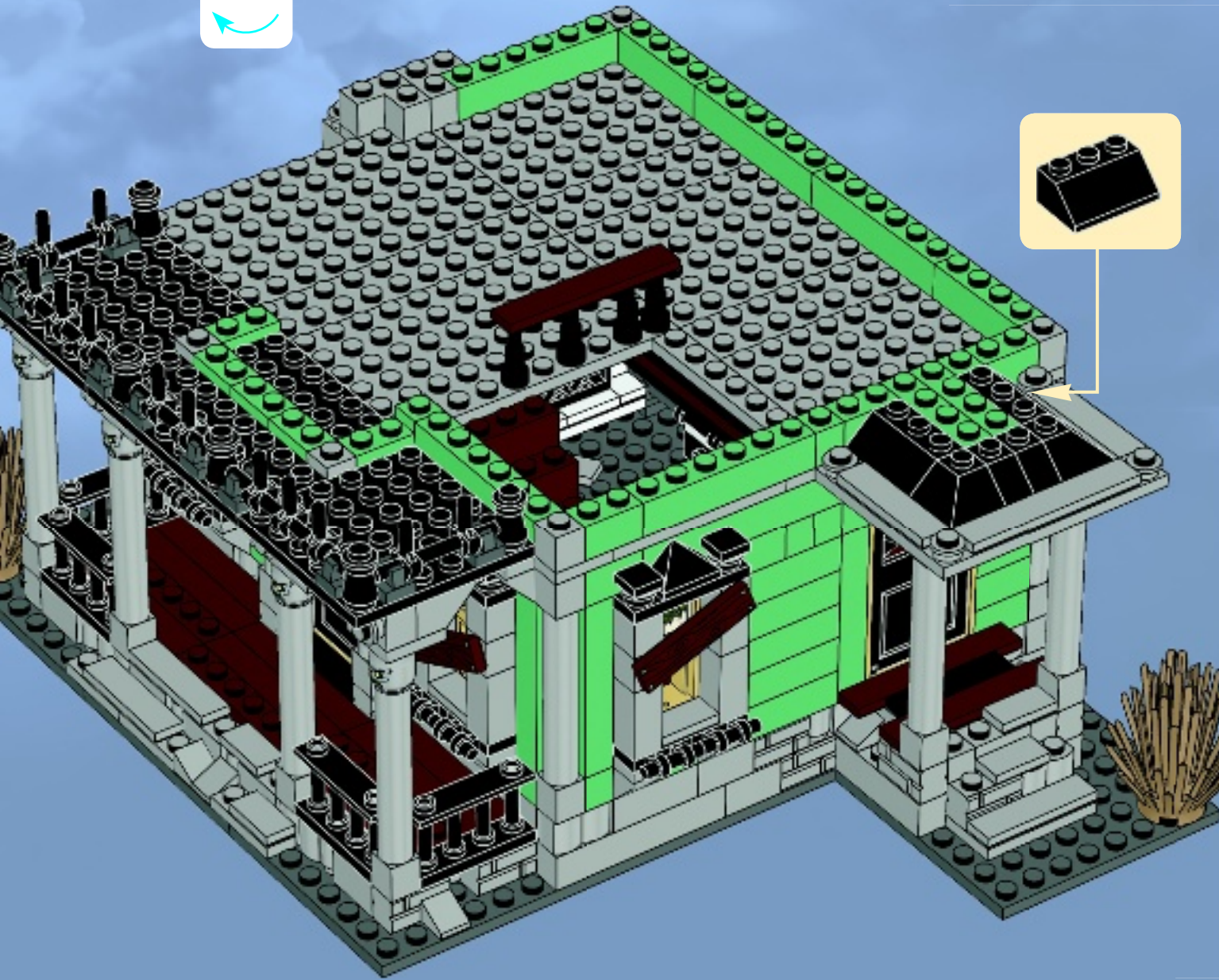



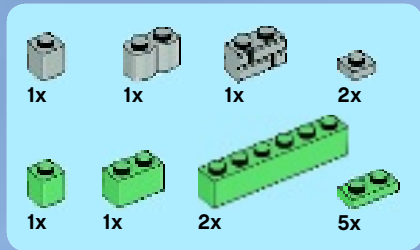

# 69

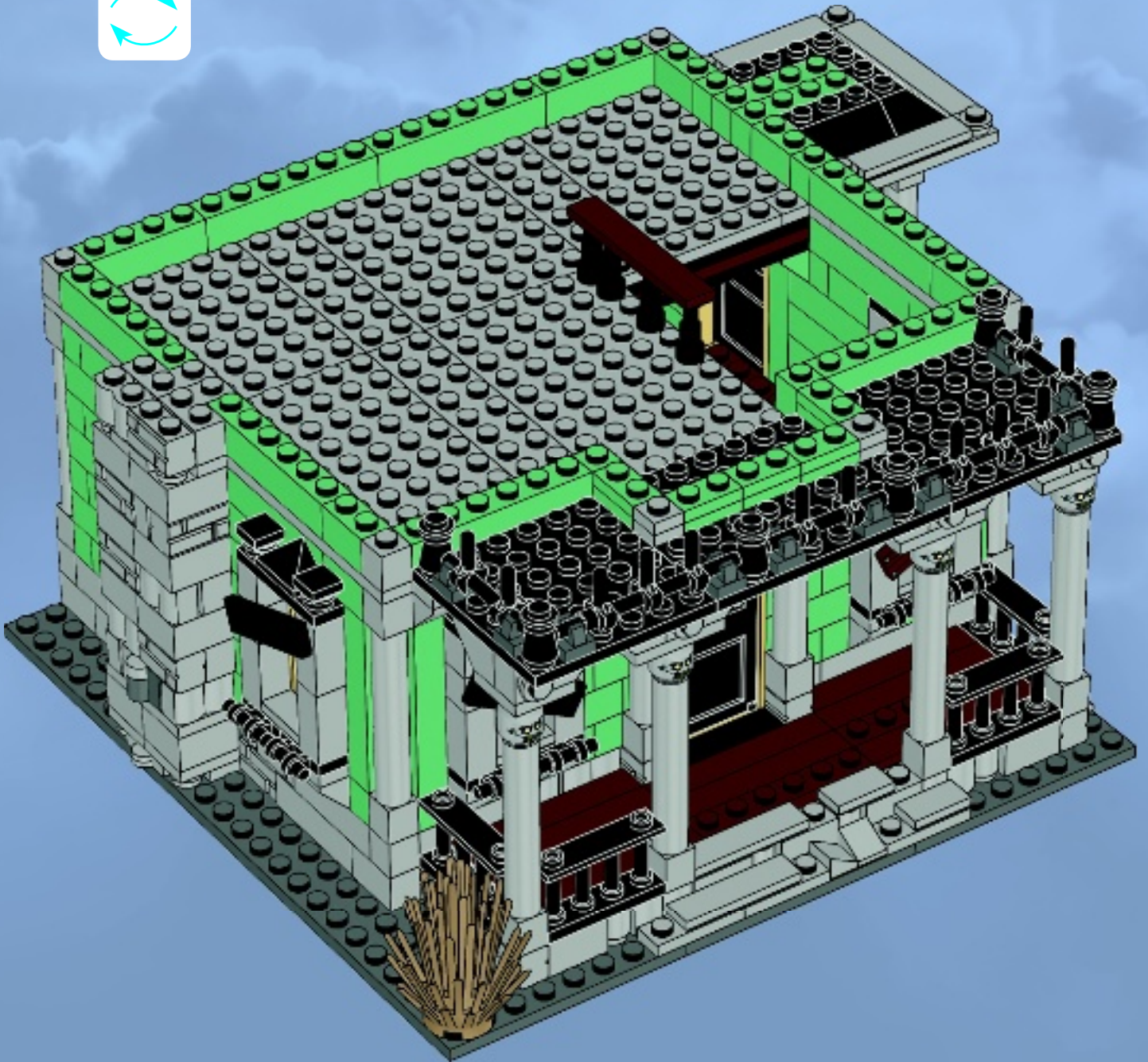



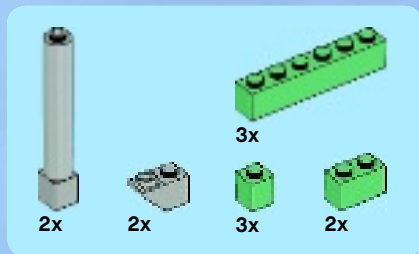

70

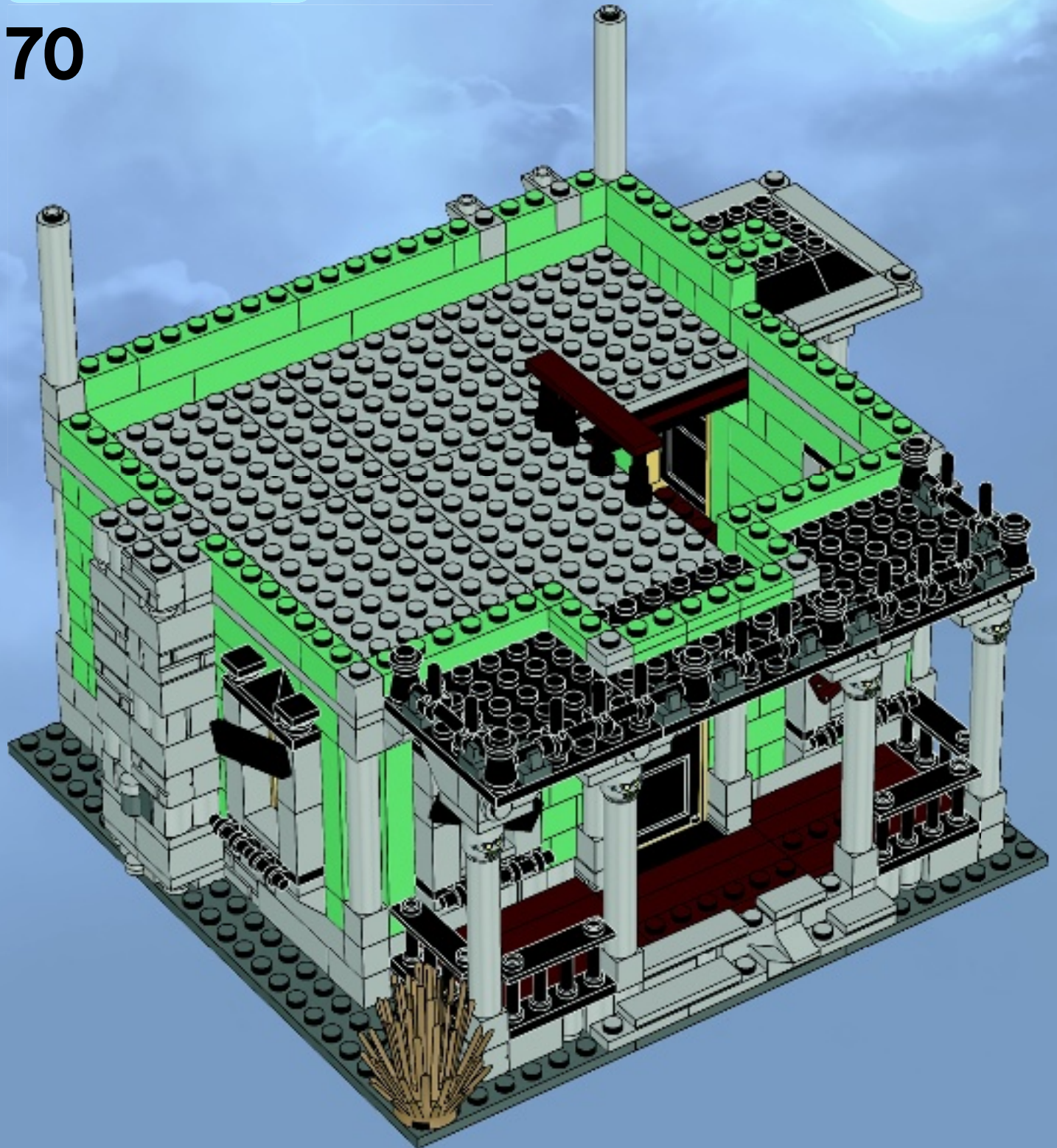



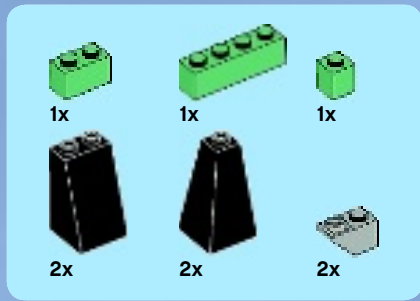

71

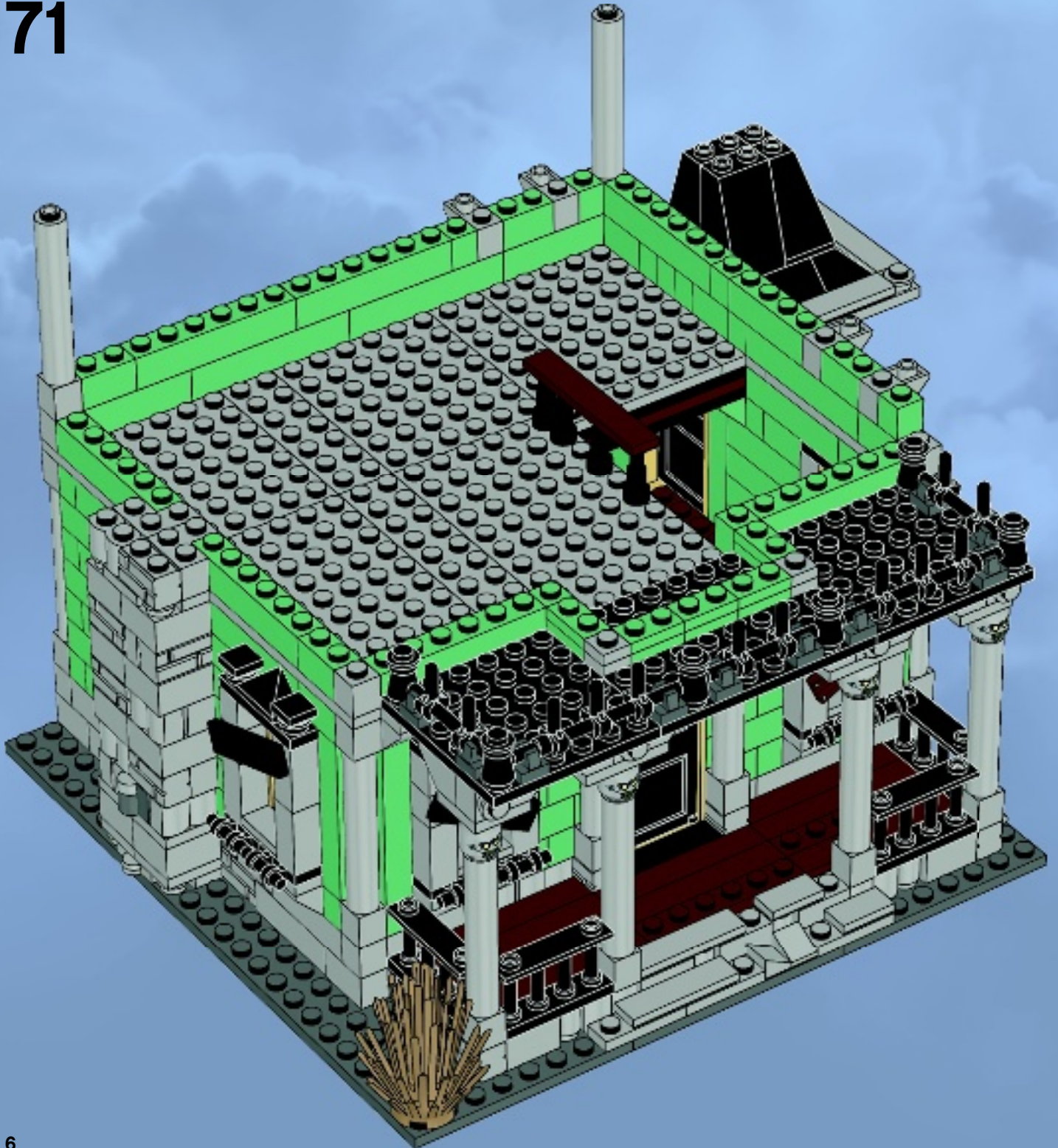





6x



8x



5x

# 72

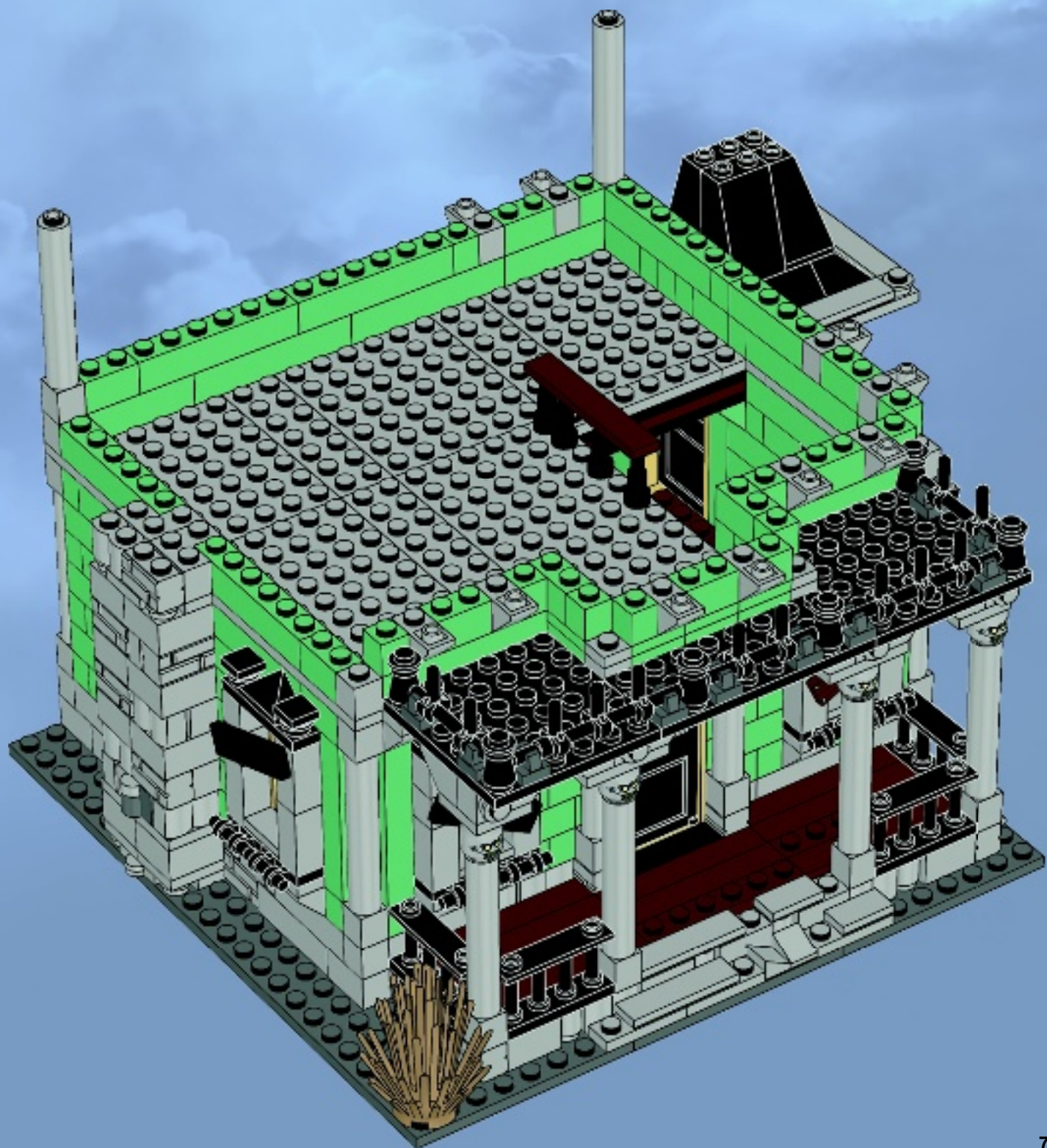



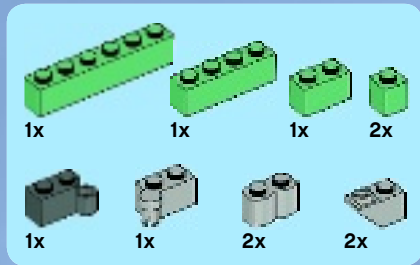

73

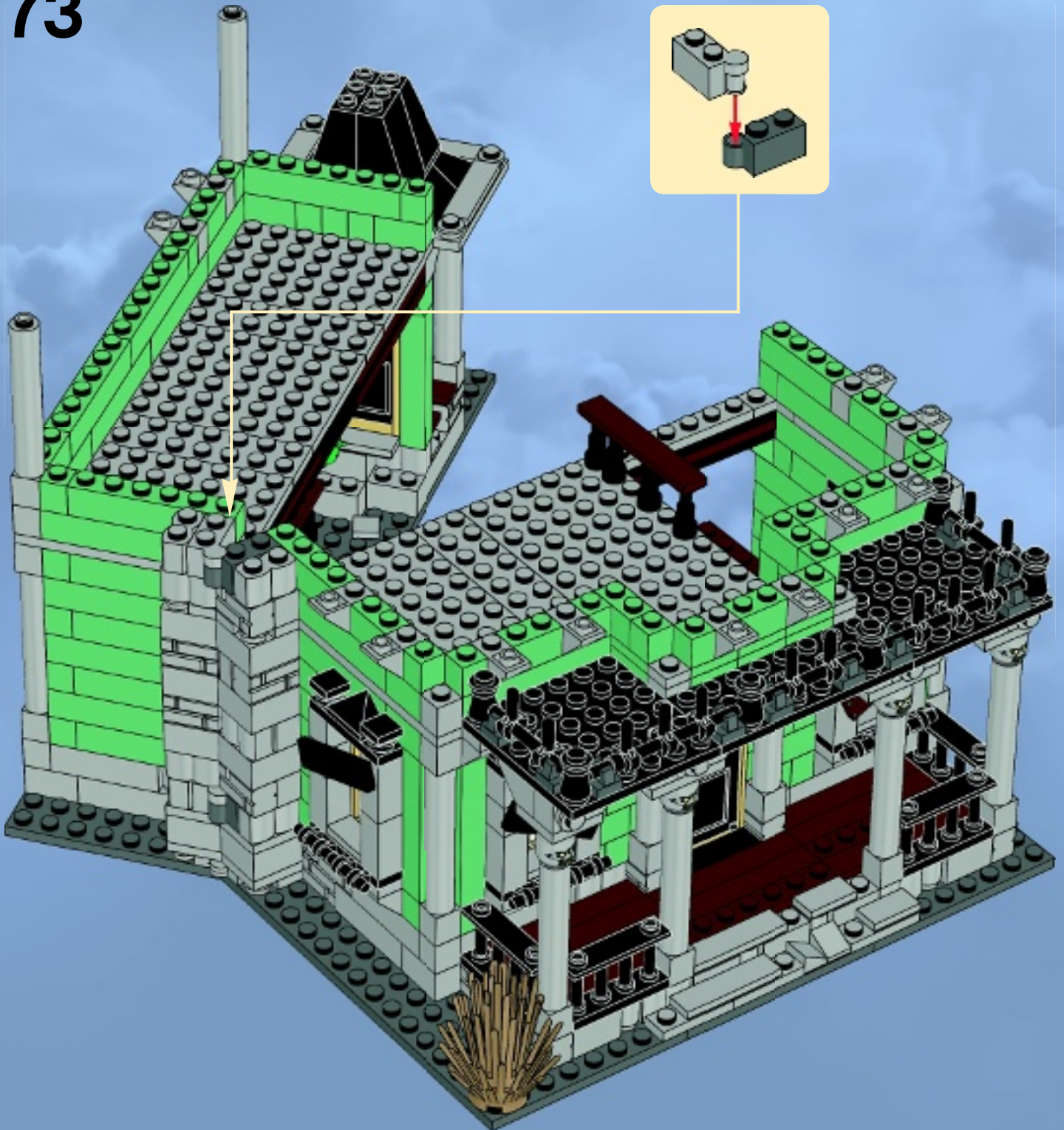
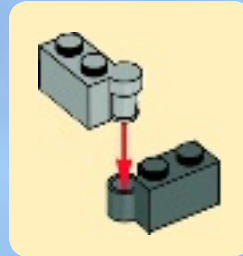



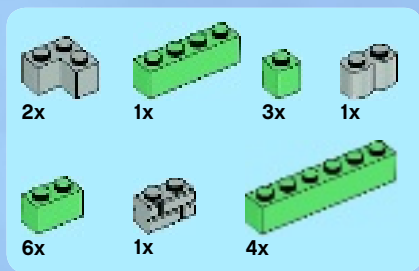

74

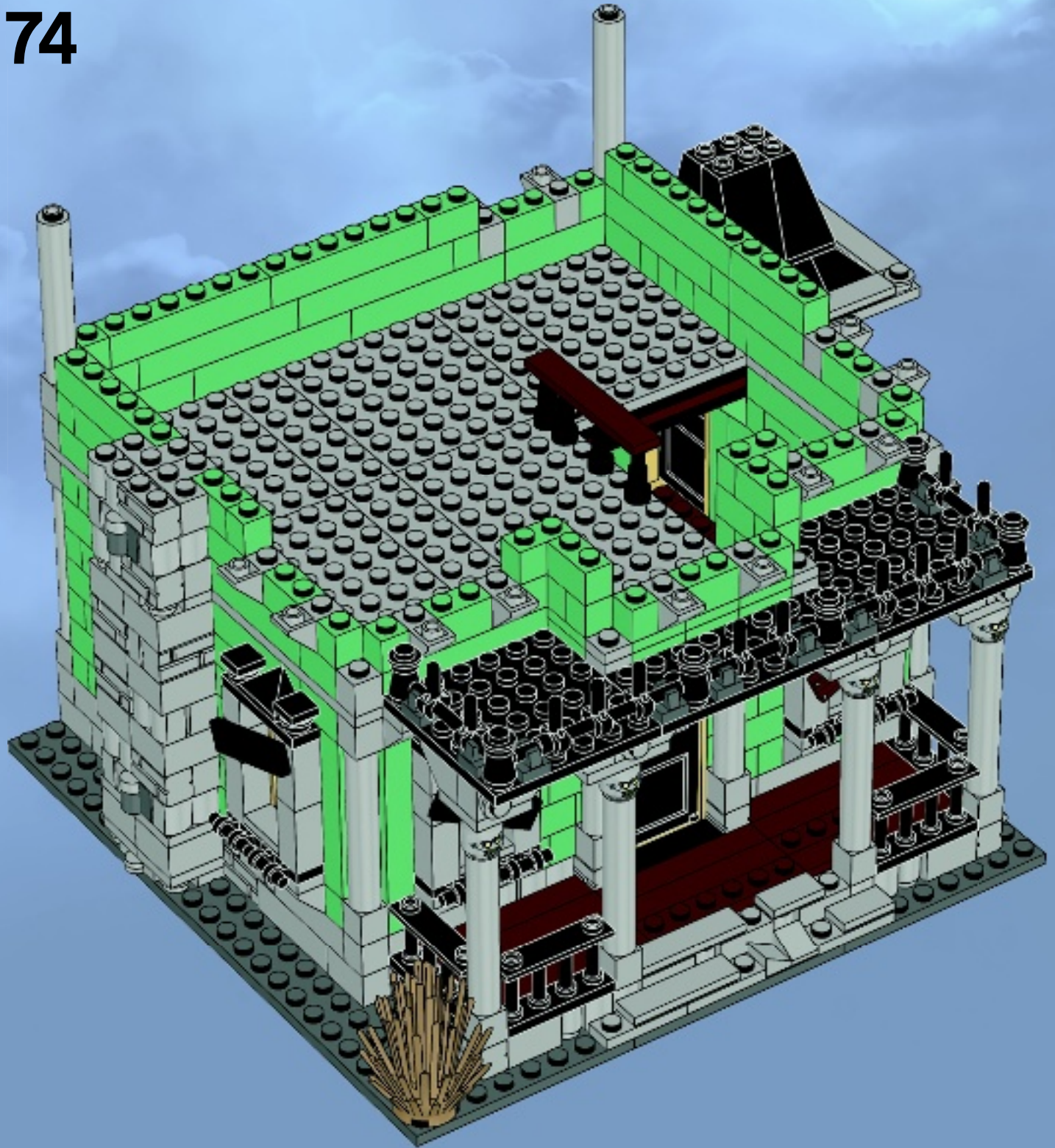



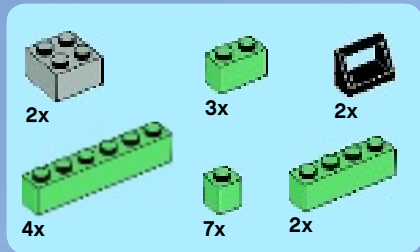

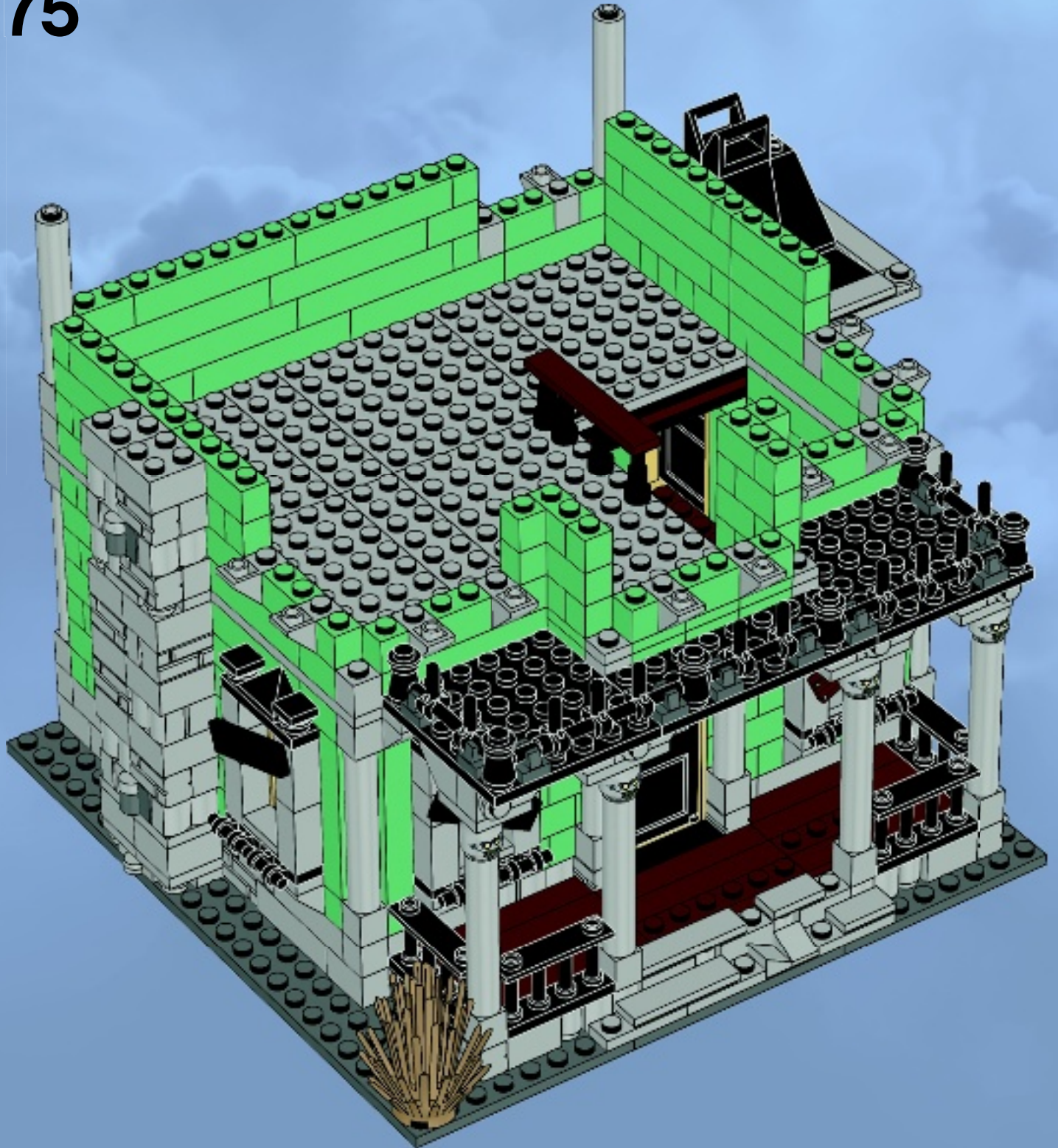

75





		
5x	2x	
		
7x	3x	1x

# 76

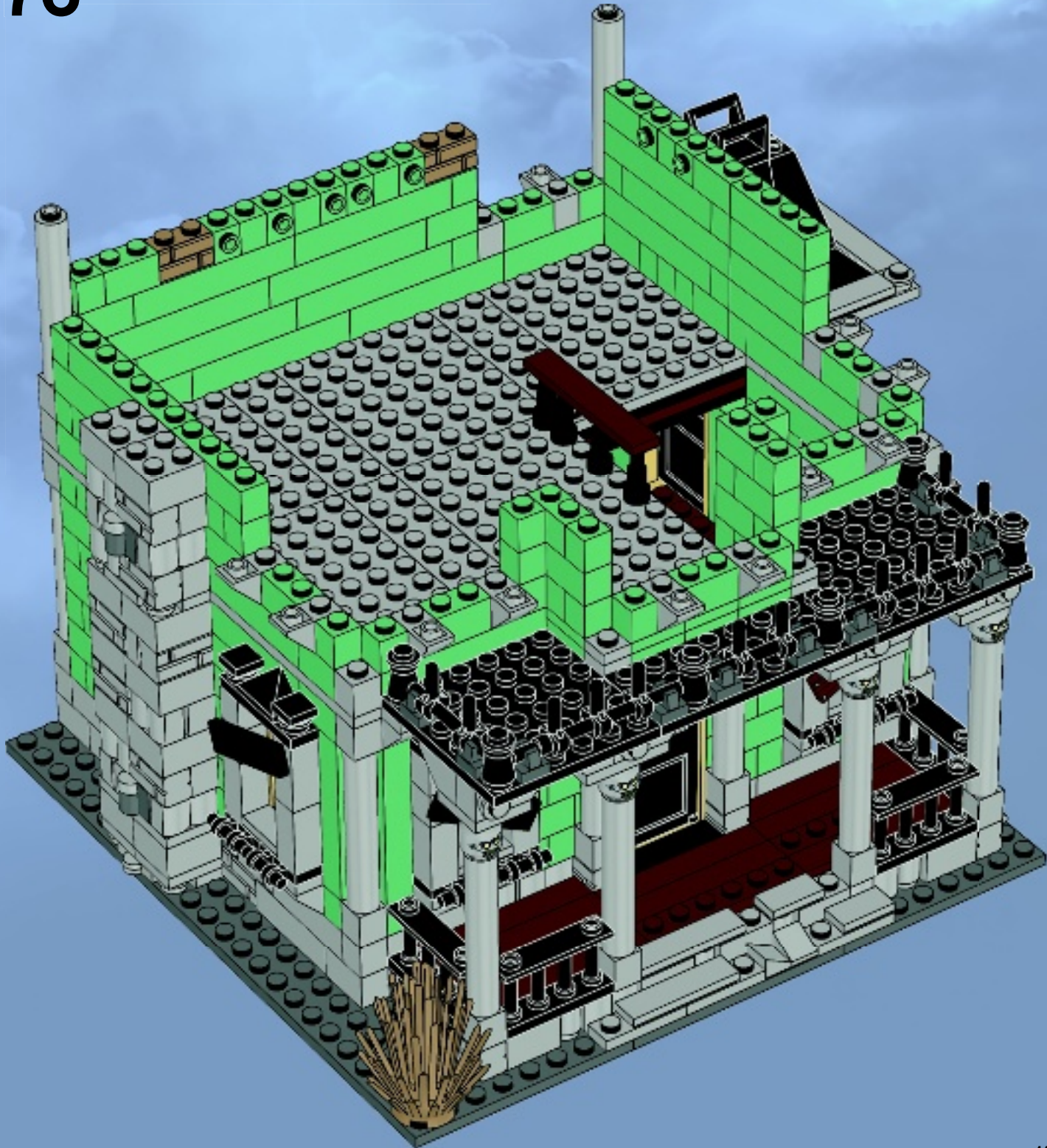



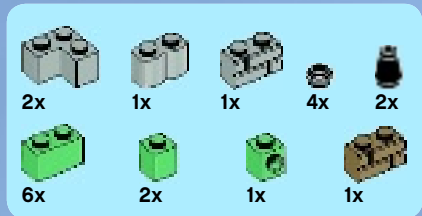







77





		
8x	5x	2x
		
1x	2x	3x

# 78

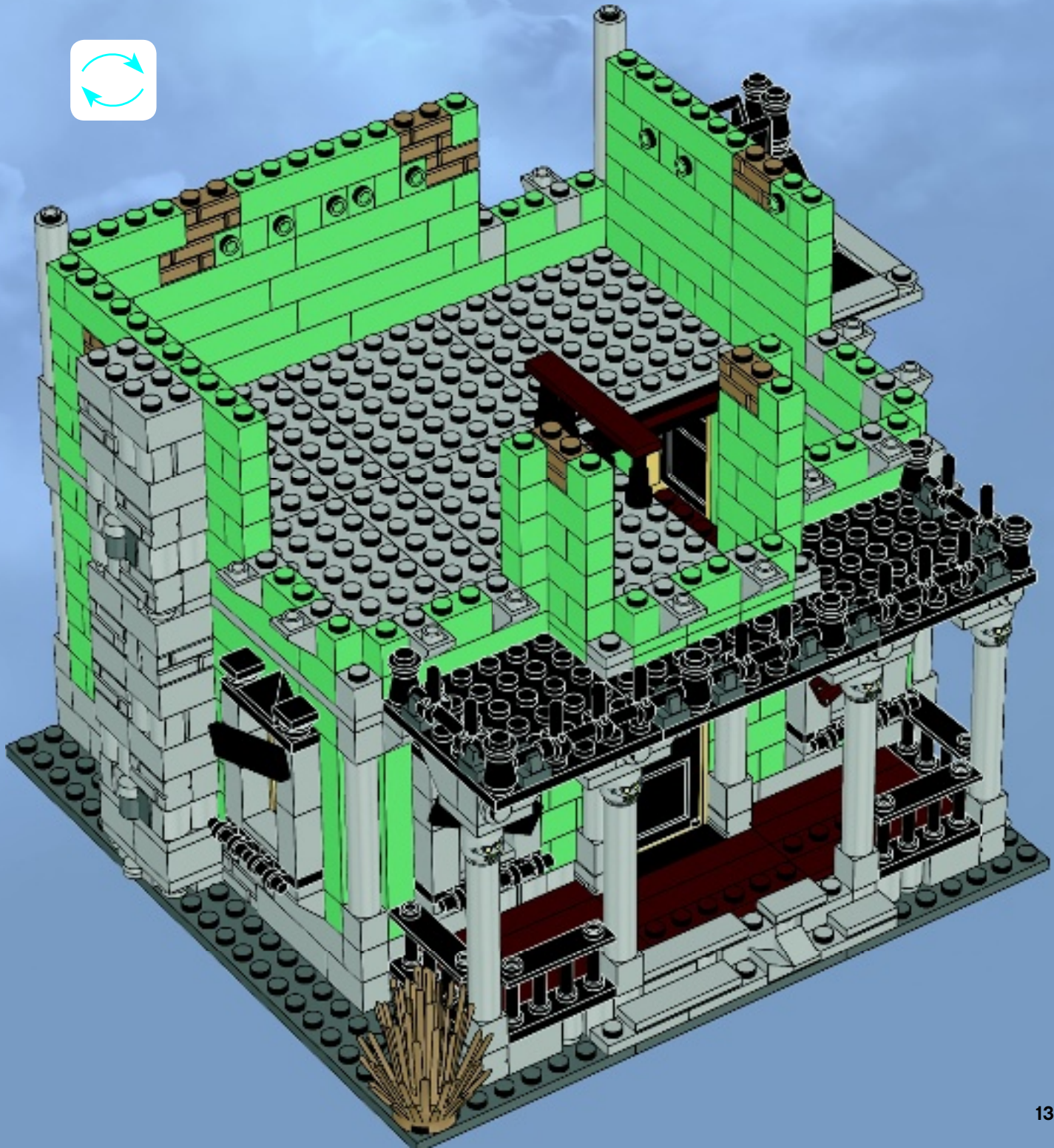



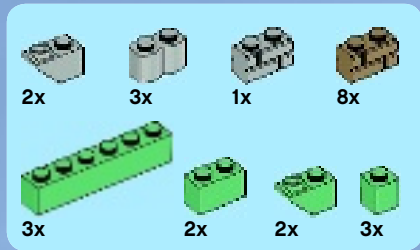

# 79

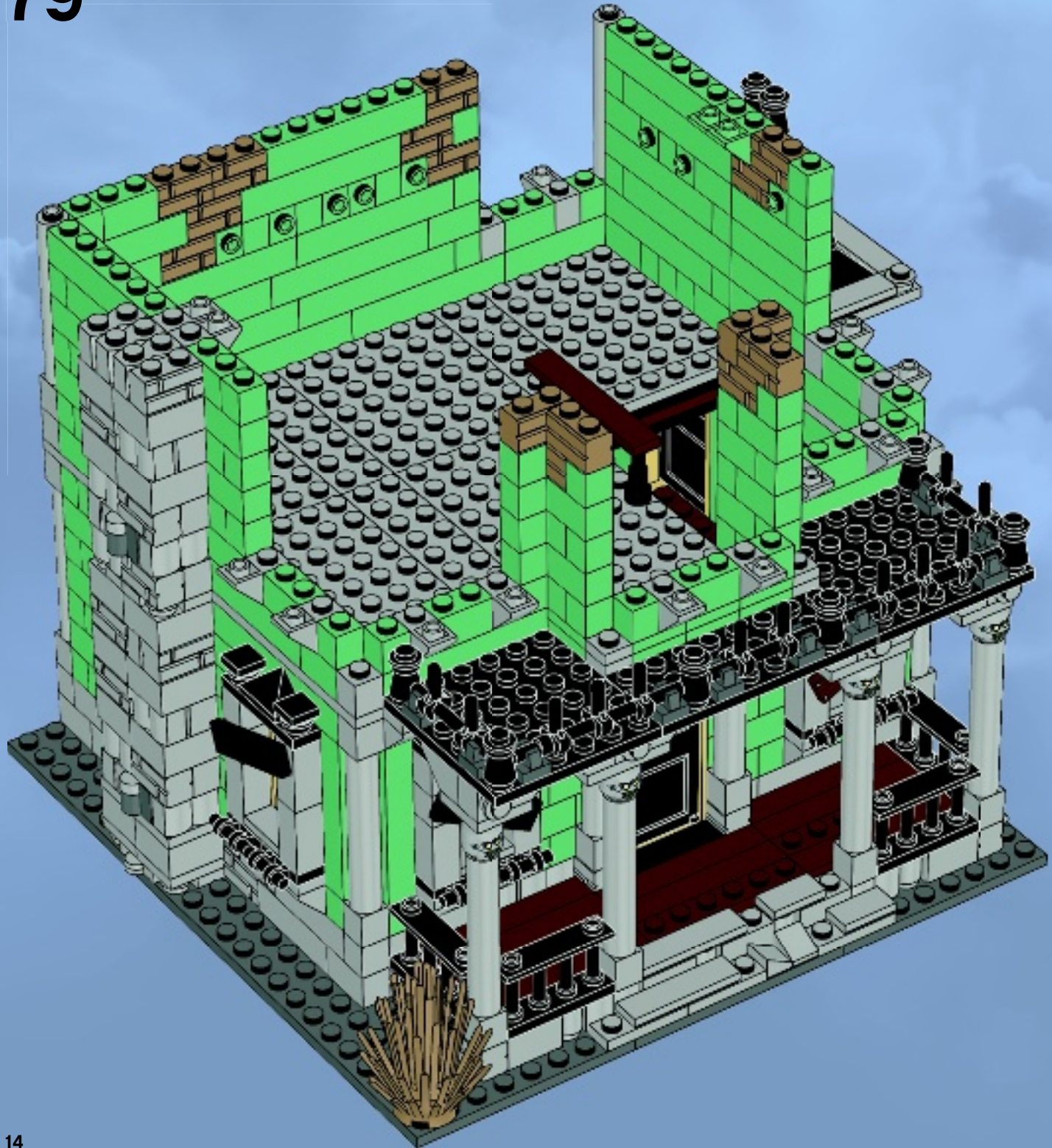



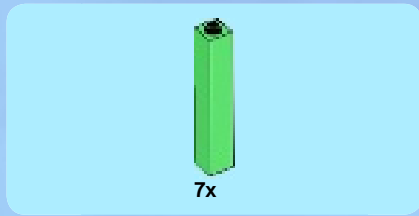

80

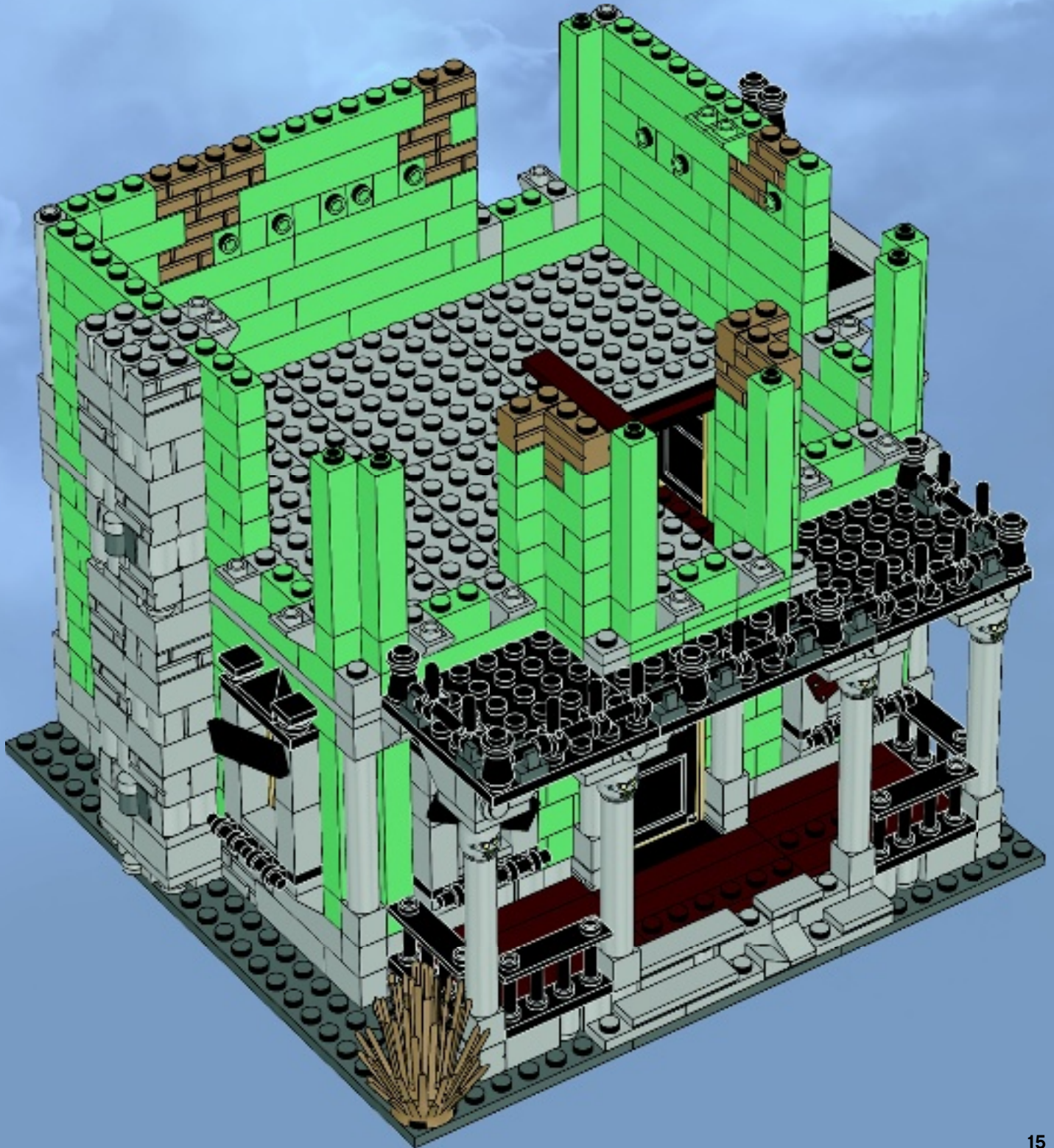





4x

# 81

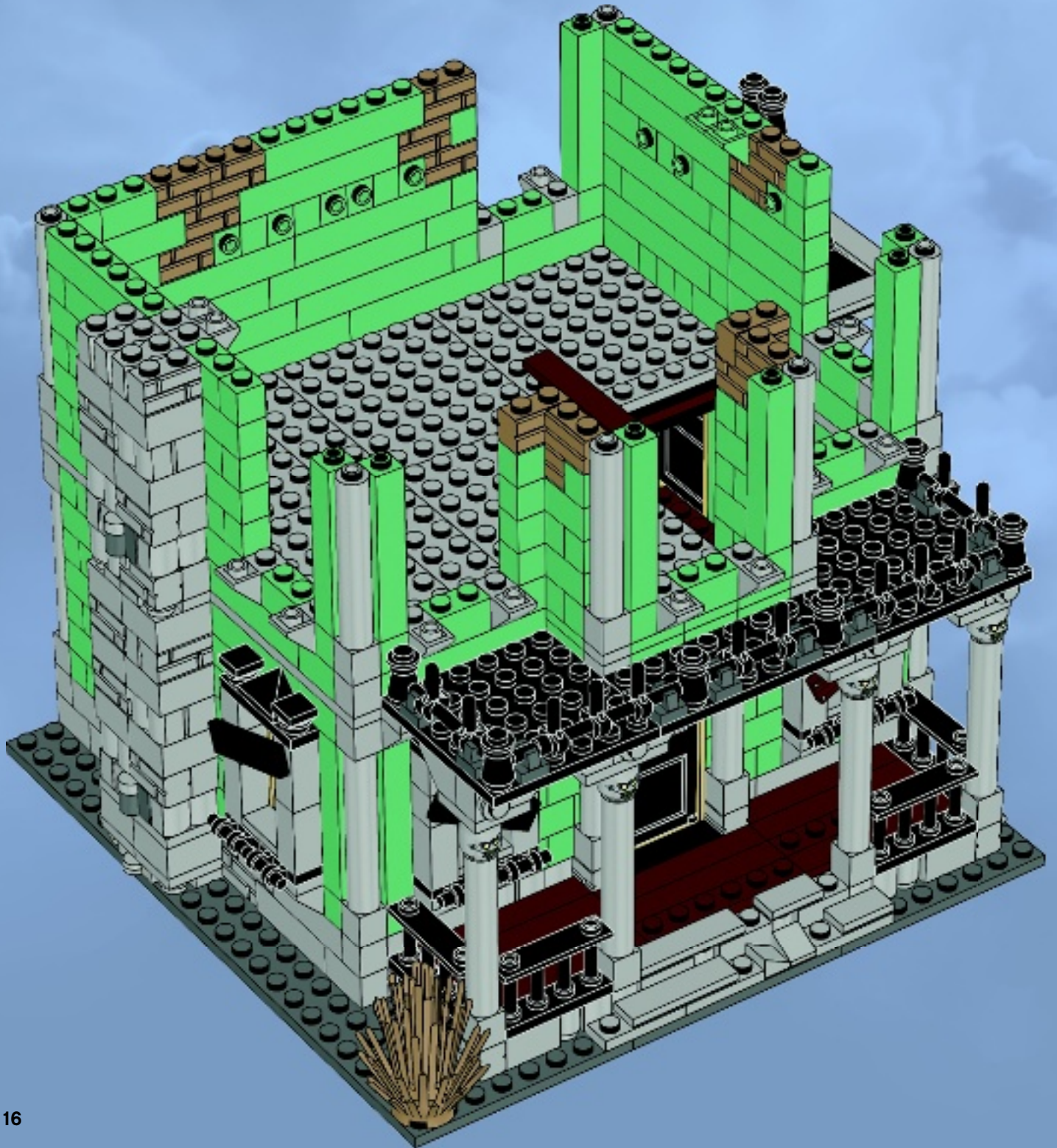



1x

1



1x



2x

2



1x



2x



1x

3



2x



1x

4

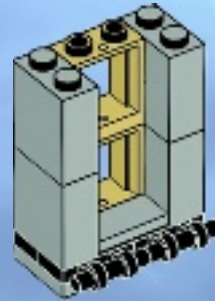

1x

5



1x



2x

6

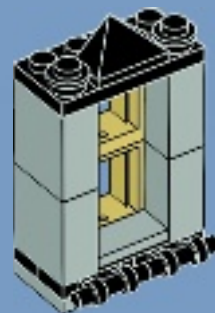



2x

7

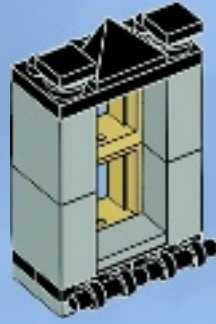

82

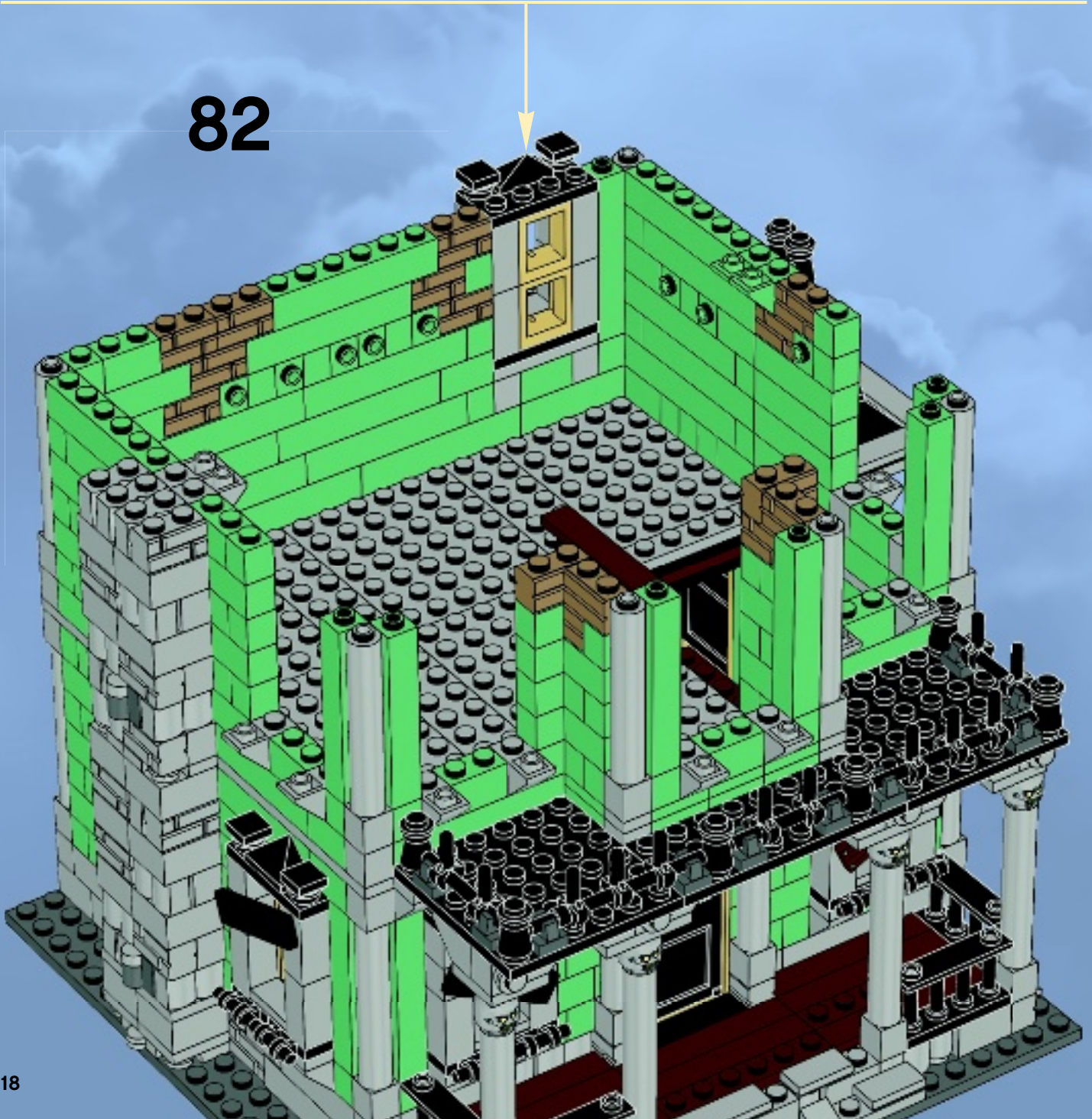



1x

1

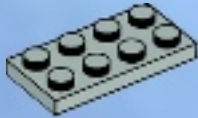

1x



2x

2



1x



1x



1x



1x

3

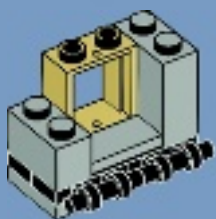

1x



1x

4

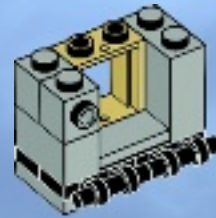

1x



1x



1x



1x

5

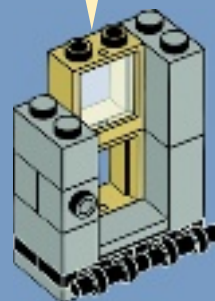
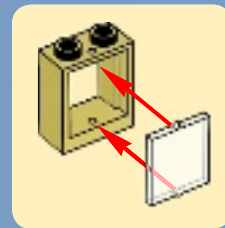





1x



1x

6

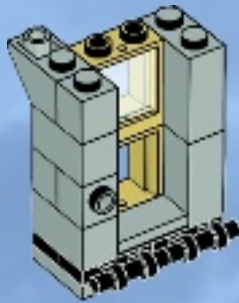

1x



2x

8



1x



1x



1x

7

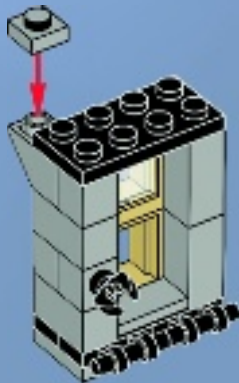

2x



1x

9



83

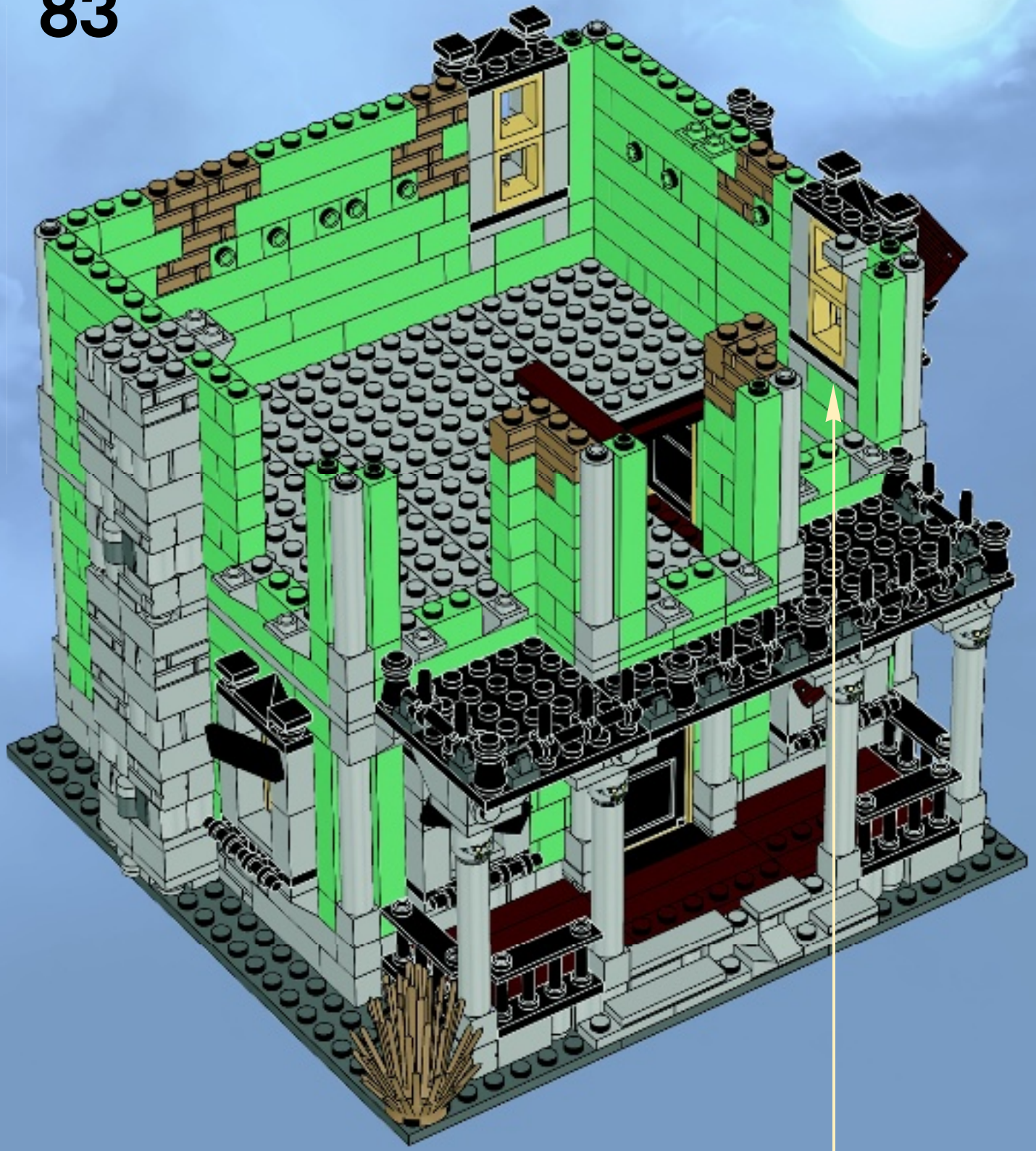





1x

1

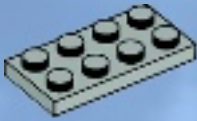

1x



2x

2



1x



2x



1x



1x

3

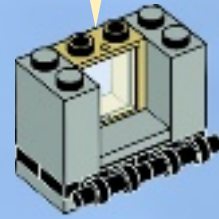
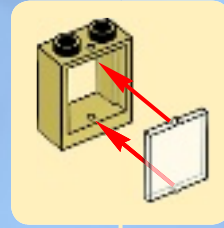

1x



1x

4

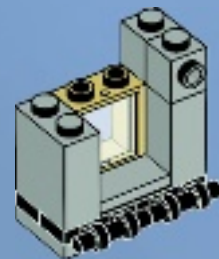

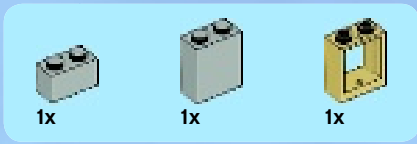

5

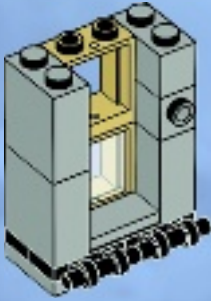

6



7



8

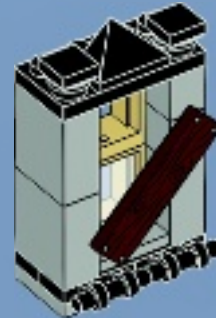



84

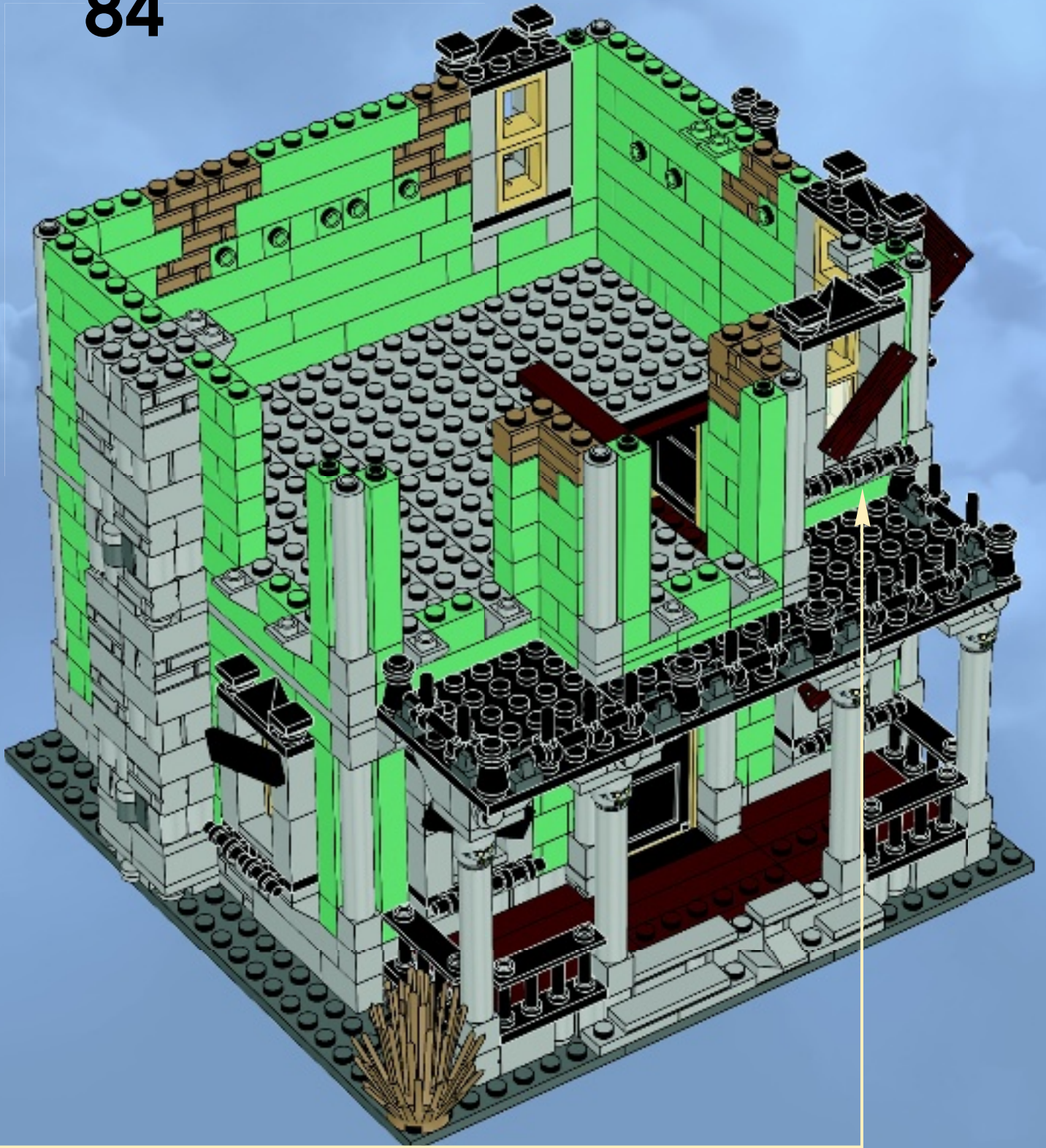



1x

1



1x



2x

2



1x



1x



1x



1x

3

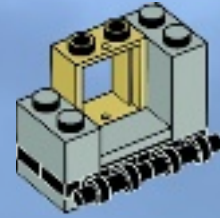

1x



1x

4

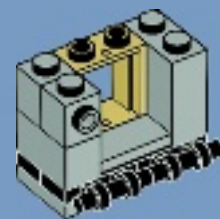



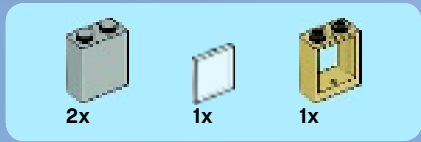

5

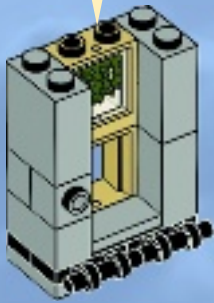
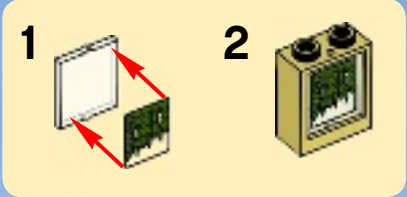

6



7

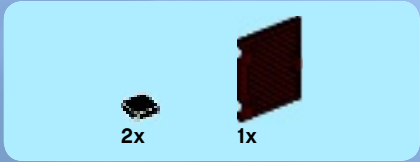

8



85

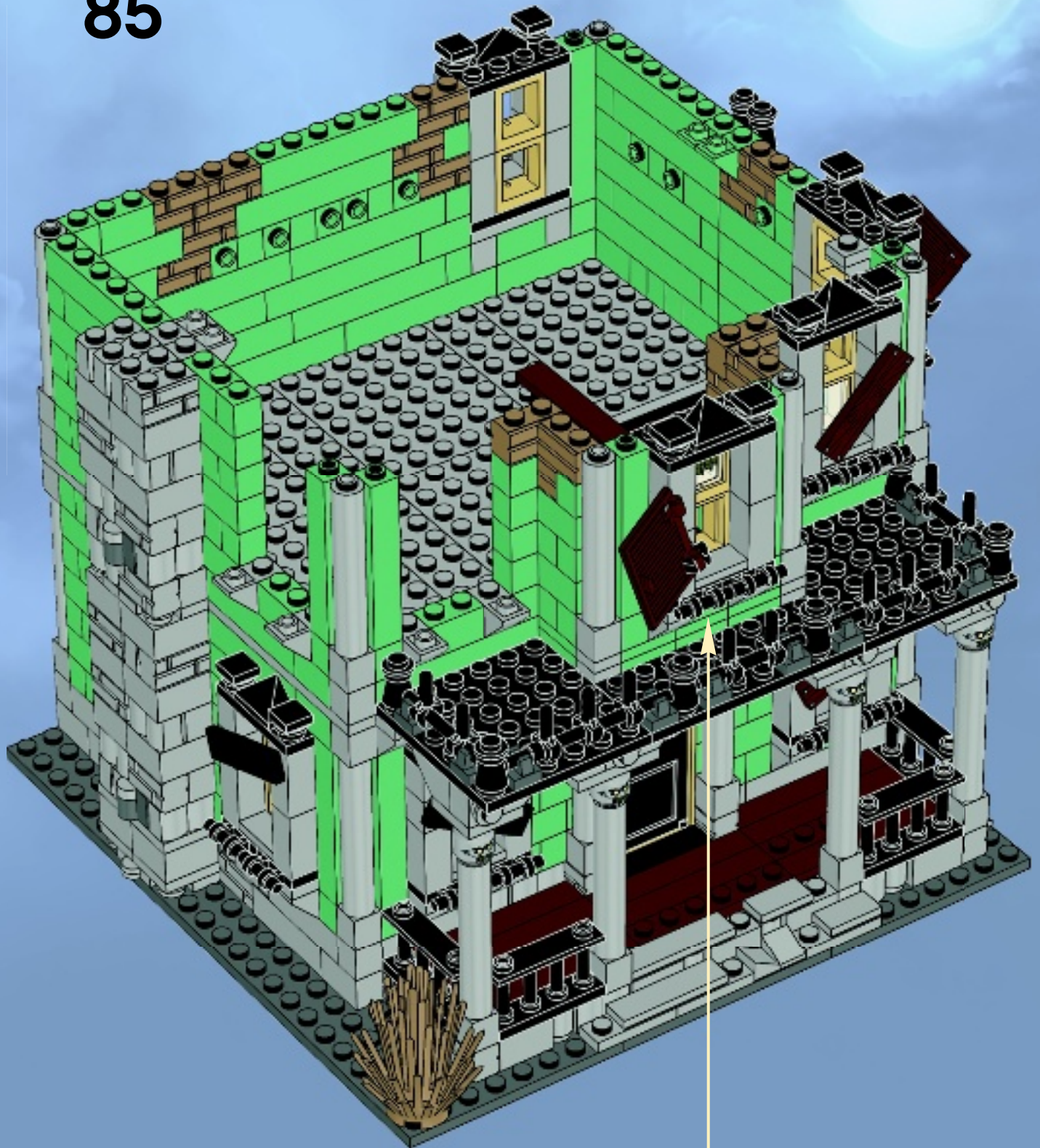





1x

1

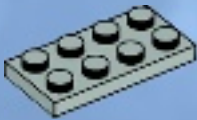

1x



2x

2



1x



1x



1x



1x

3

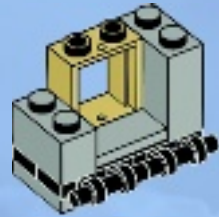

1x



1x

4

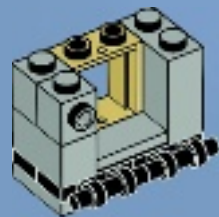



2x



1x



1x

# 5

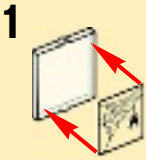

1



2

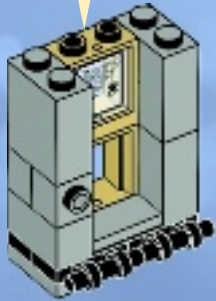

1x



1x

# 6



1x



2x

# 7



2x



1x

# 8





86

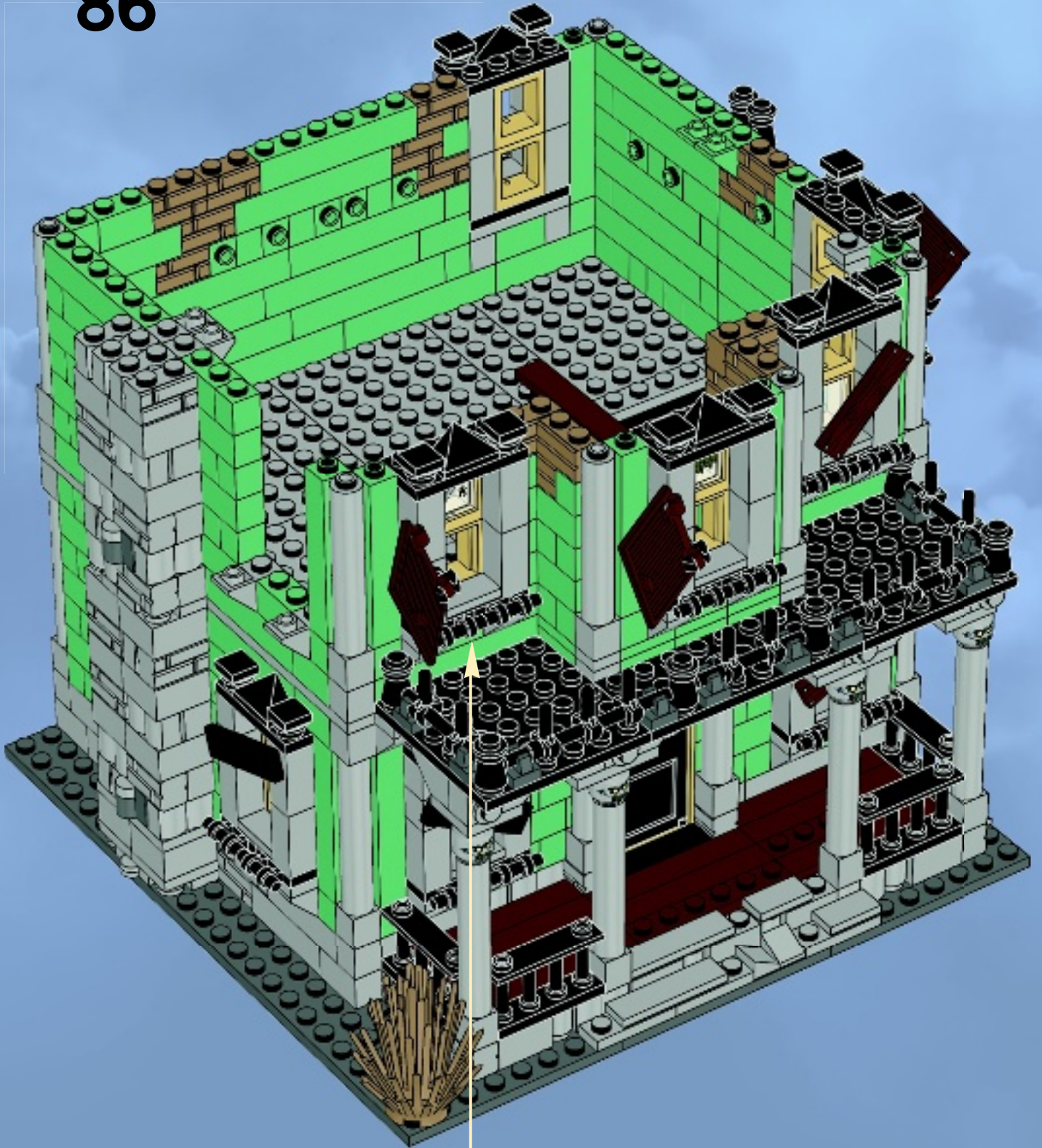



1x

1

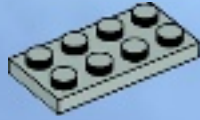

1x



2x

2



1x



1x



1x



1x

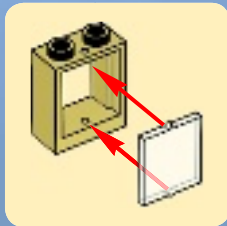

3

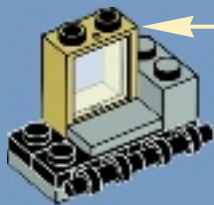

1x



1x



1x

4

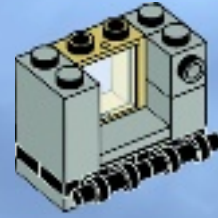

1x



1x

5

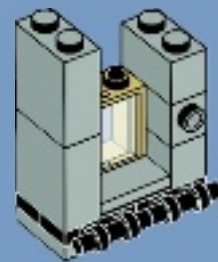



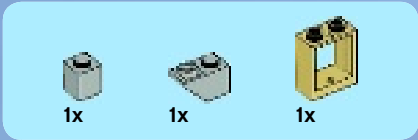

6

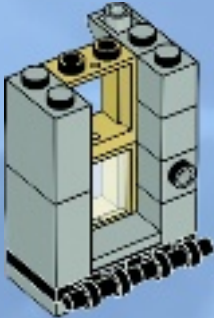

7



8

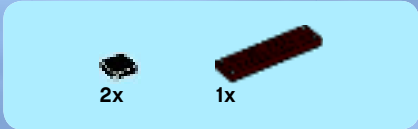

9



87

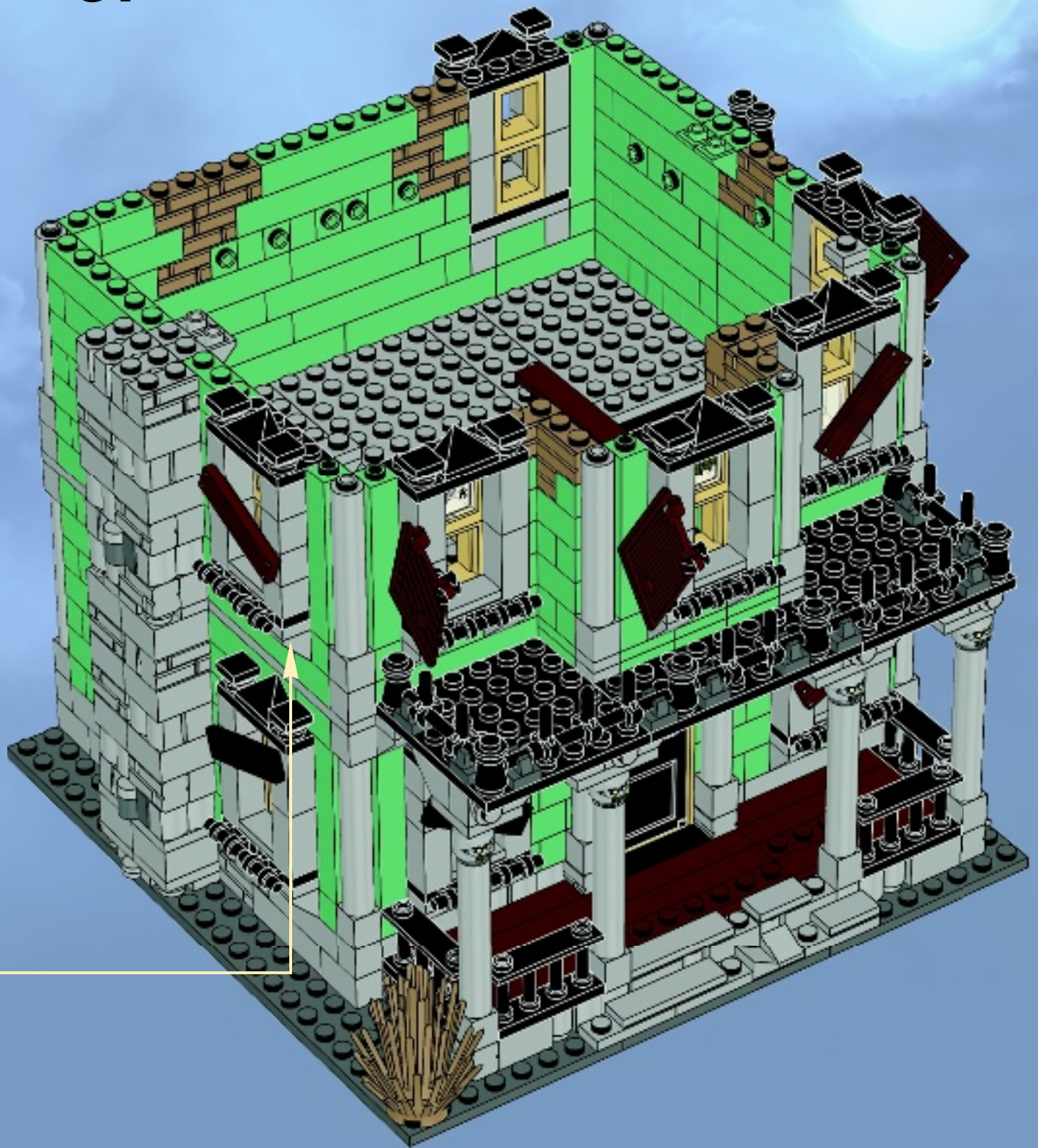



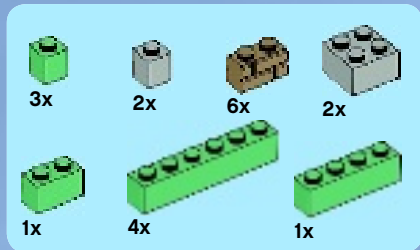

88

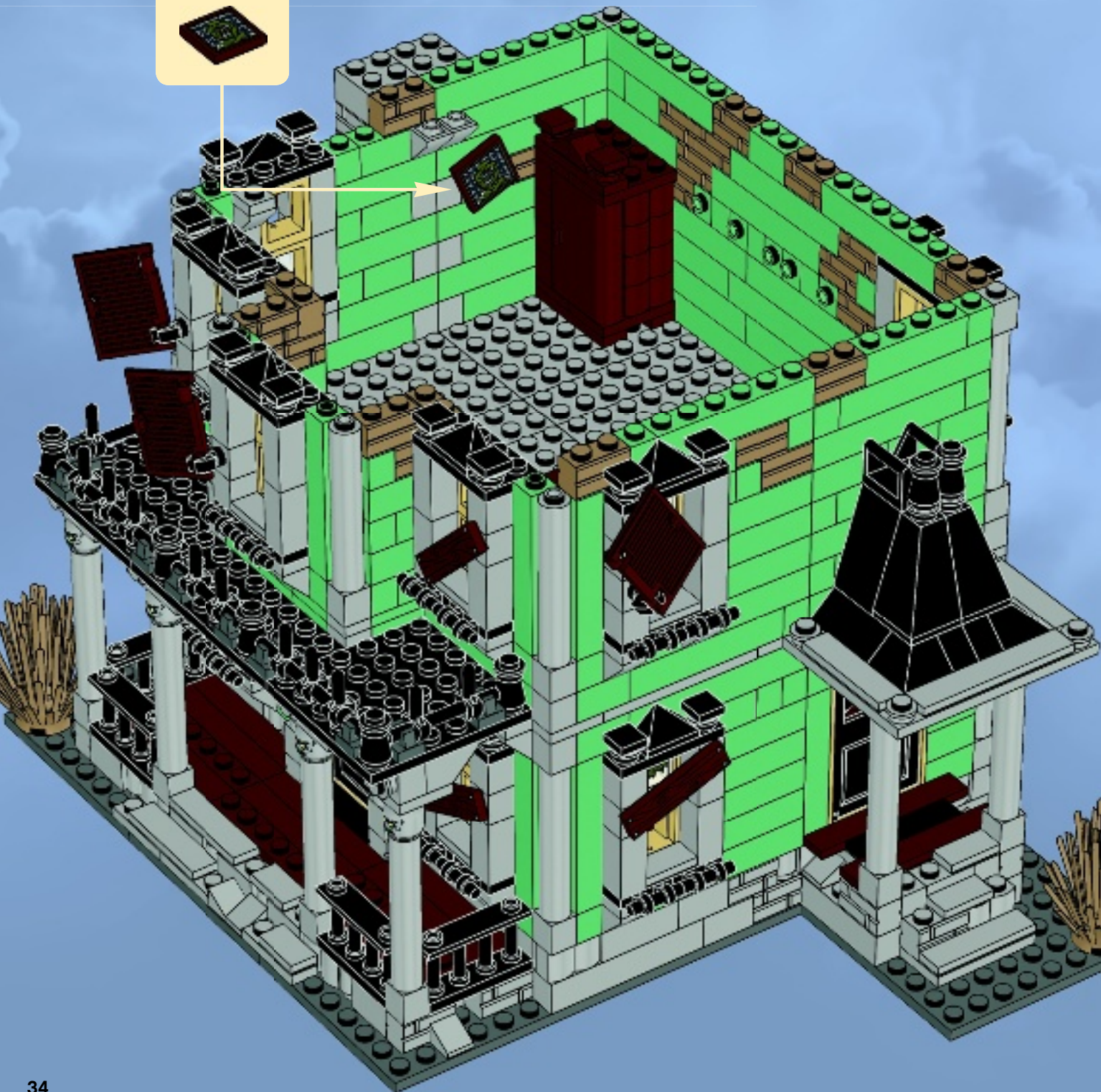



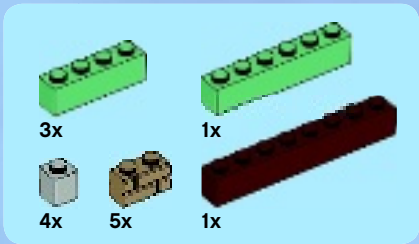

89

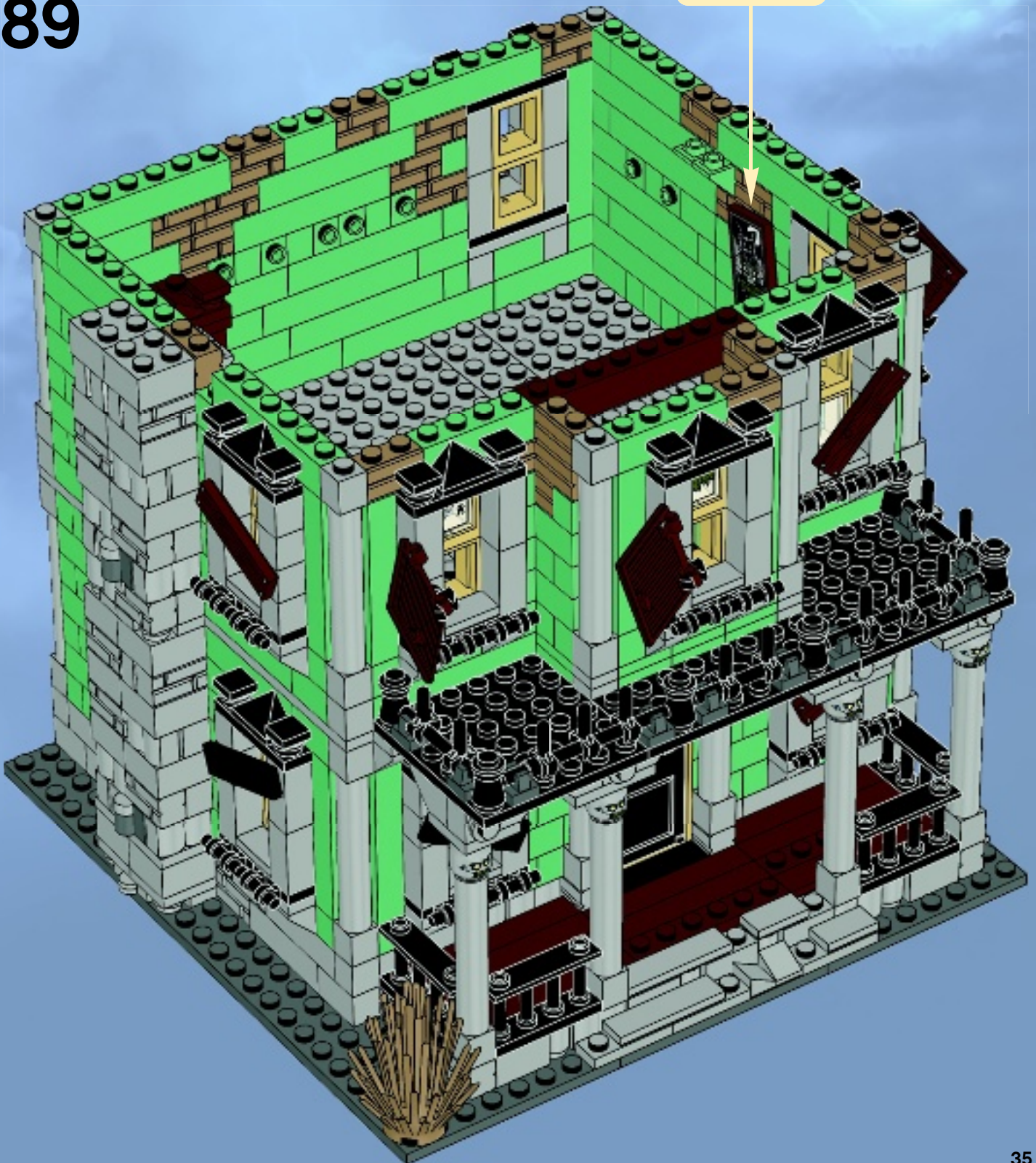



90

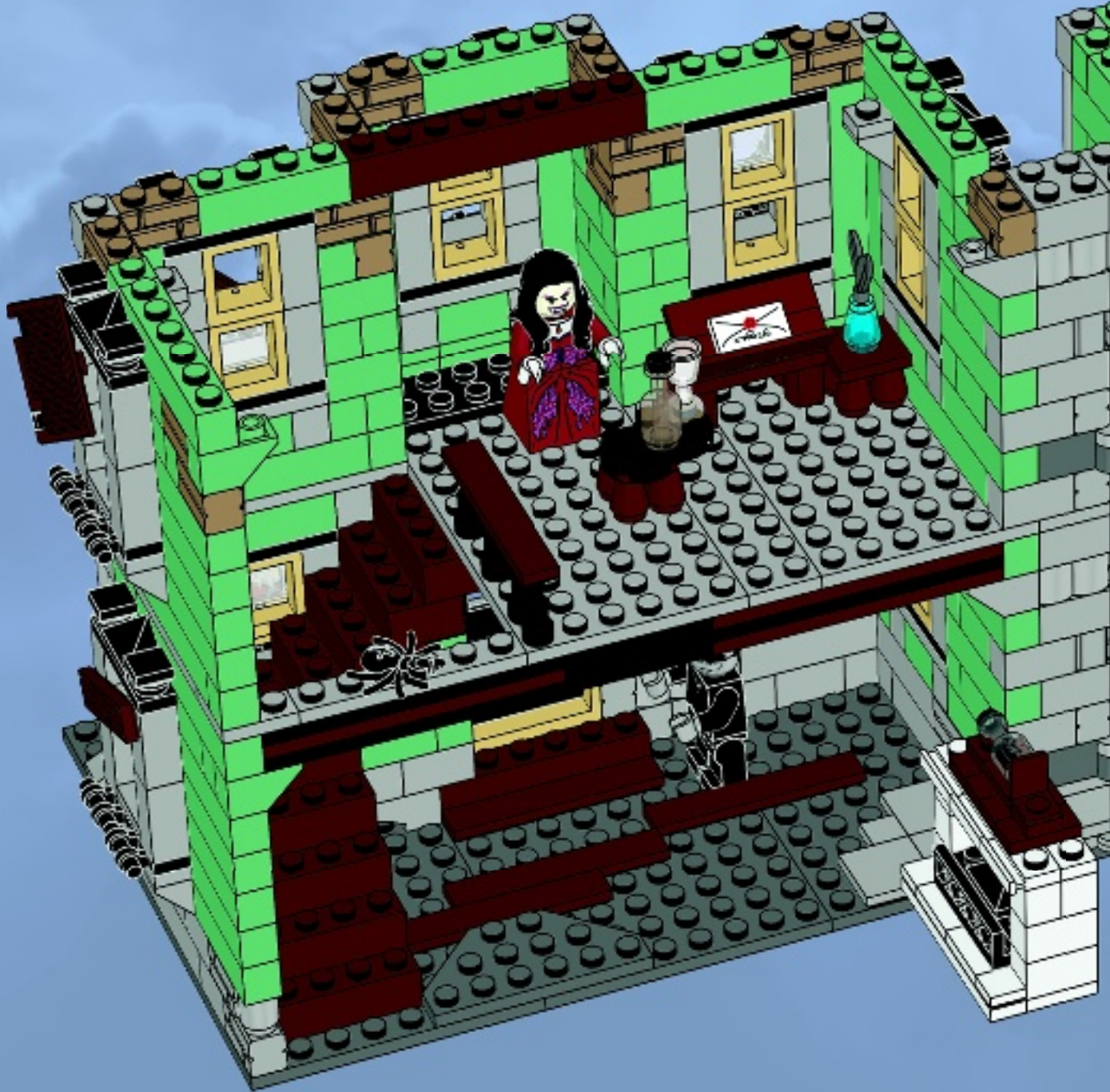

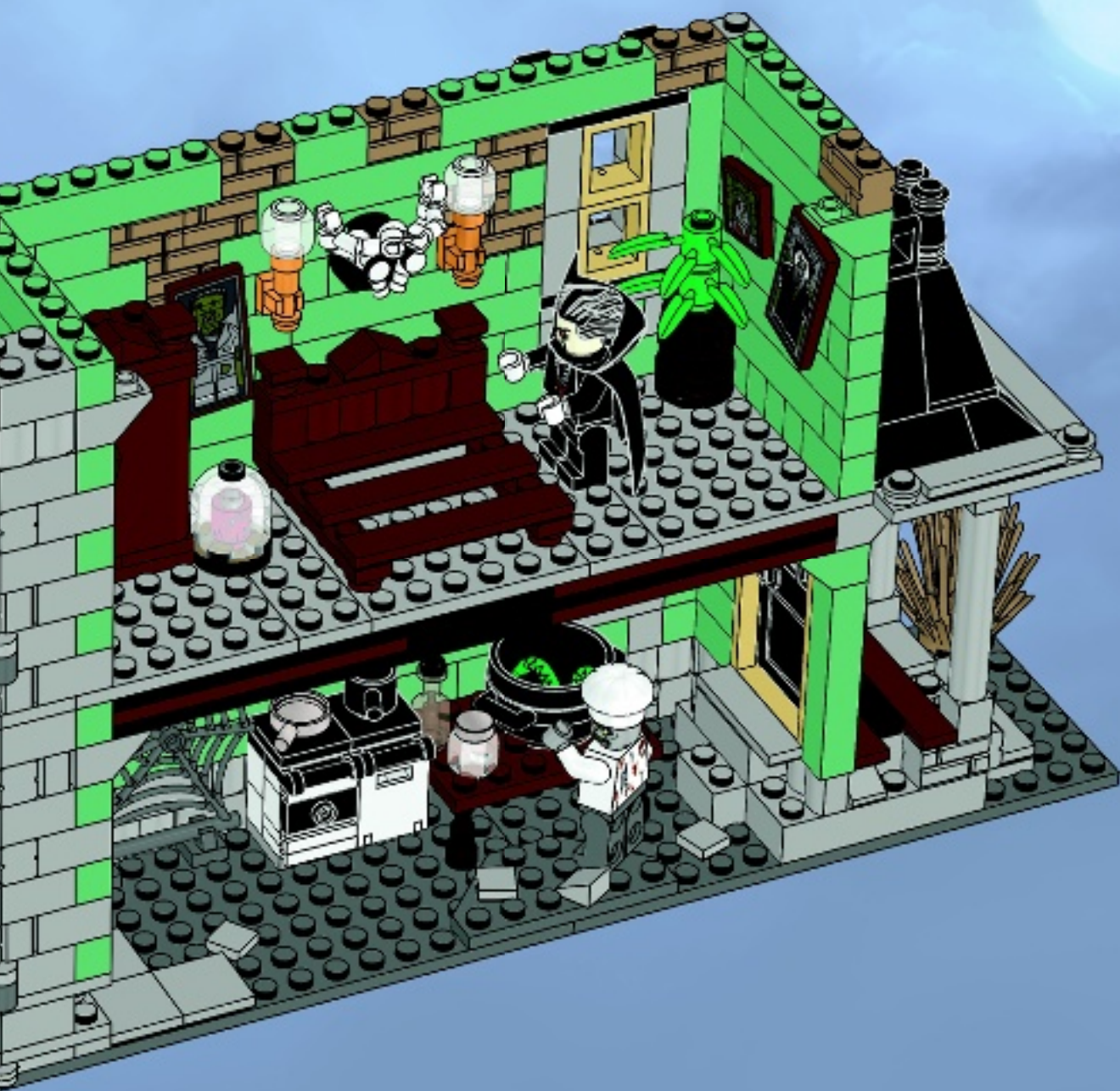





1

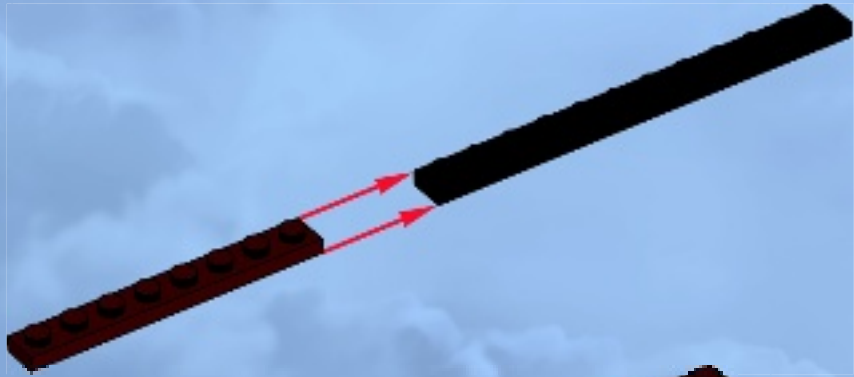

2

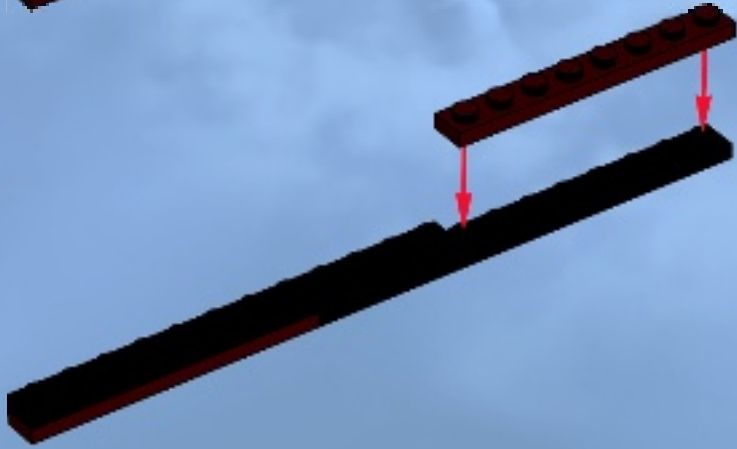

3



3x

91

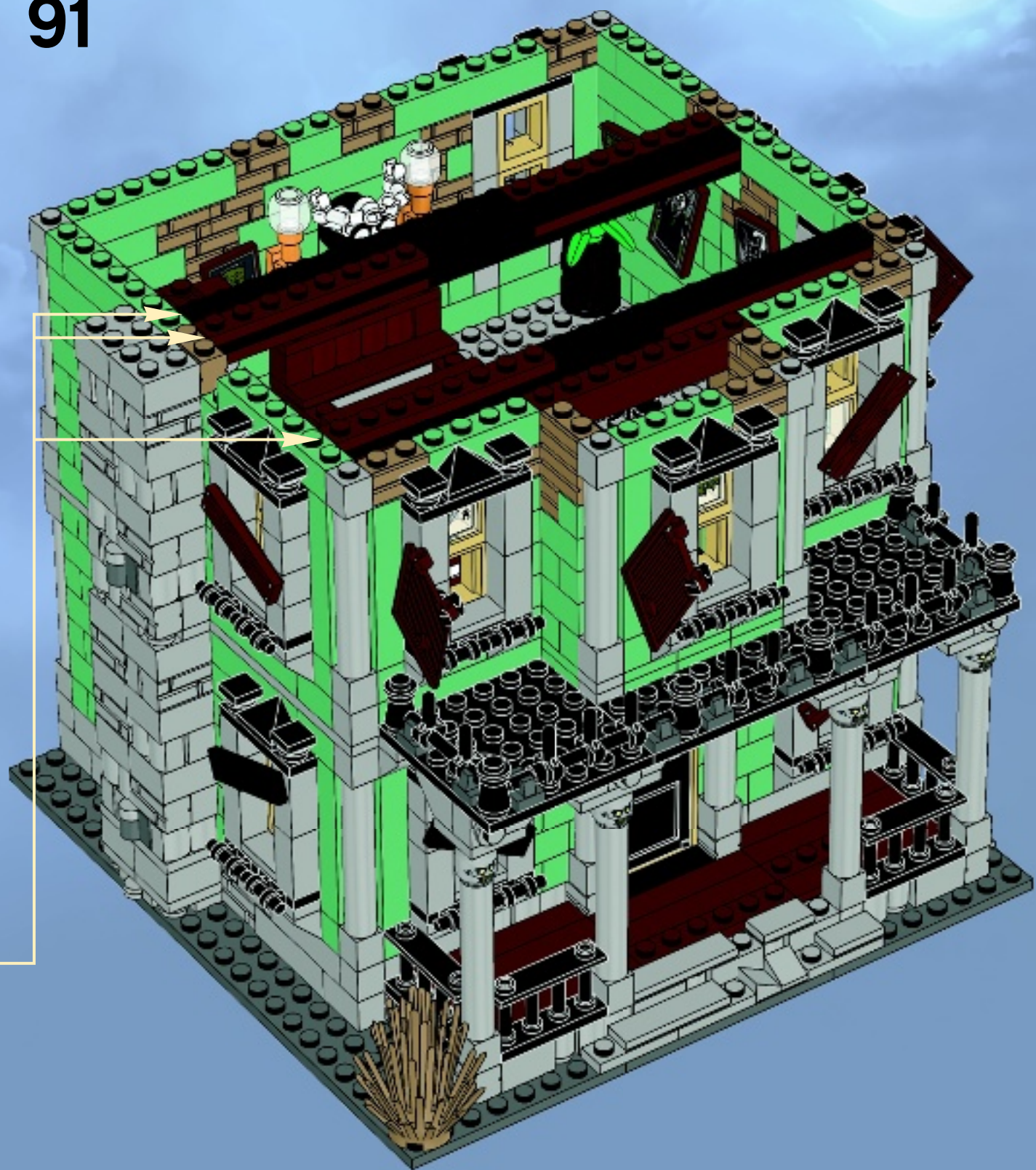



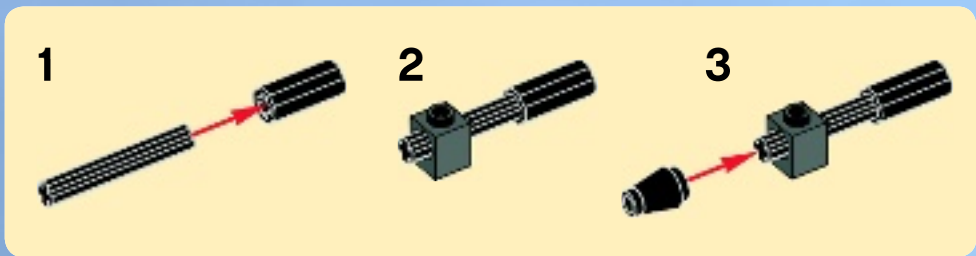
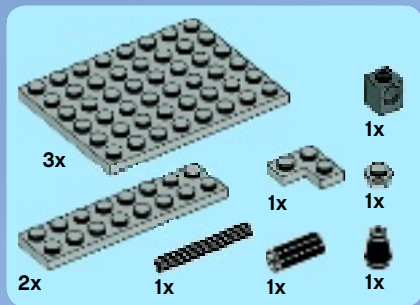

# 92

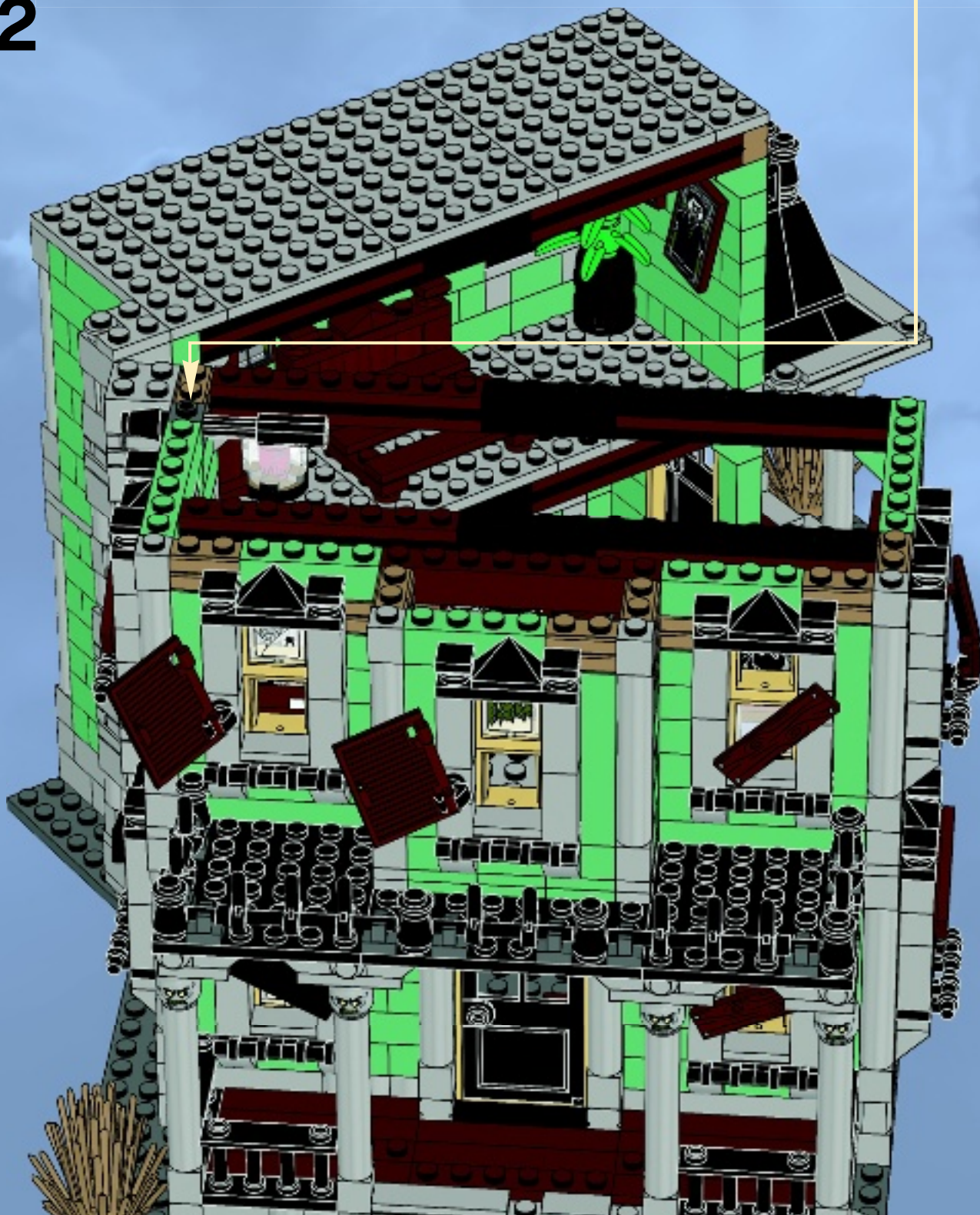



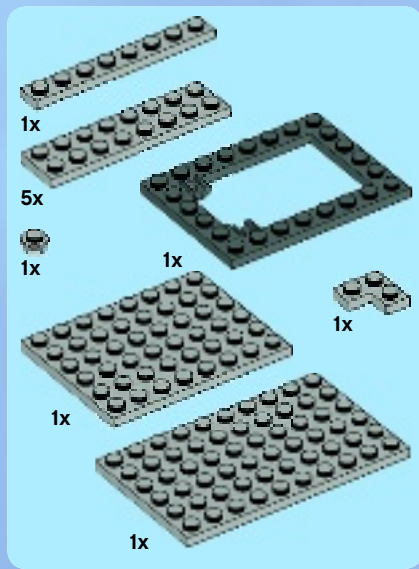

93

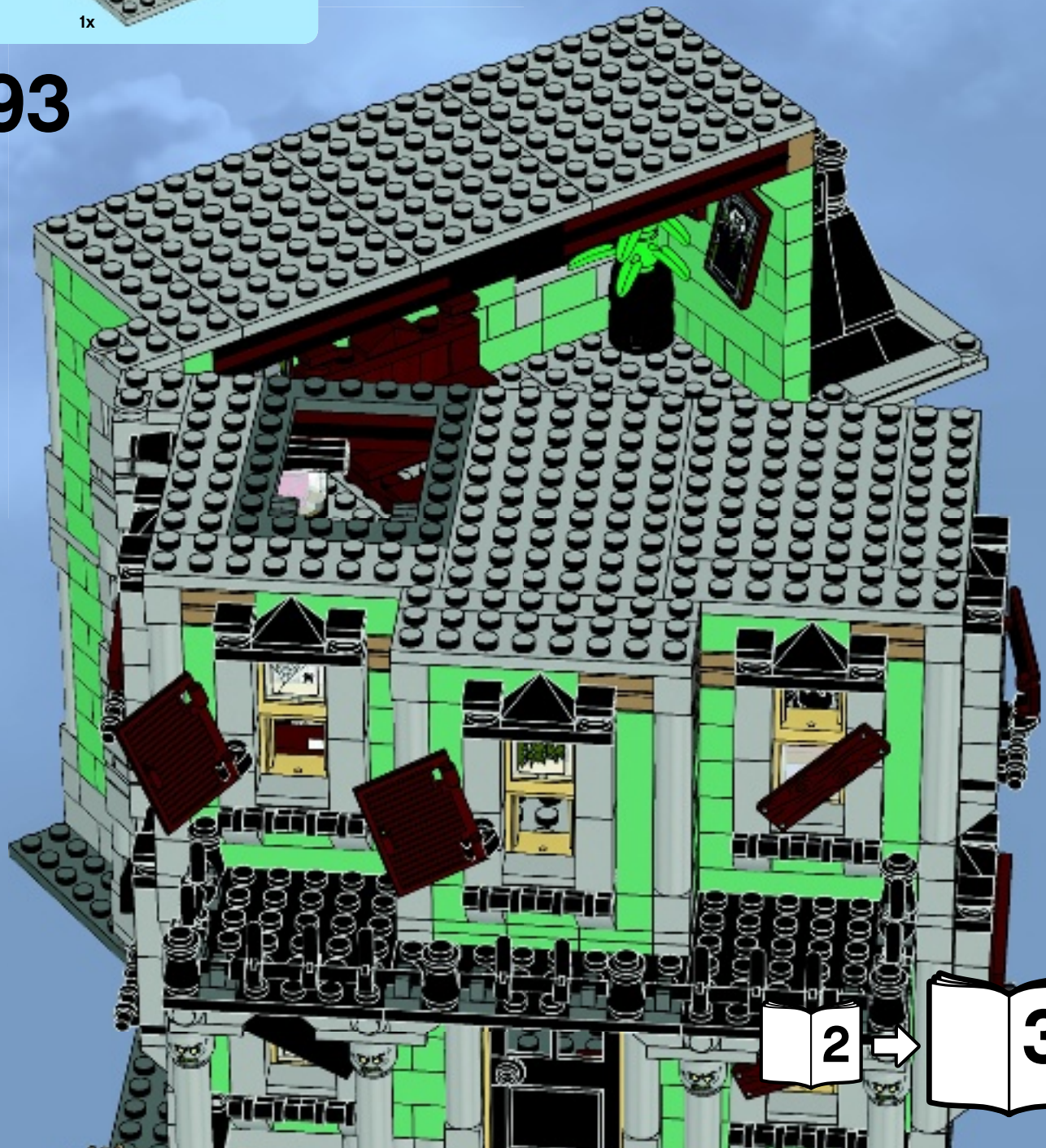





# MONSTER FIGHTERS



9461



9462



9463



9464



9466



9467



9468



LEGO

# MONSTER FIGHTERS

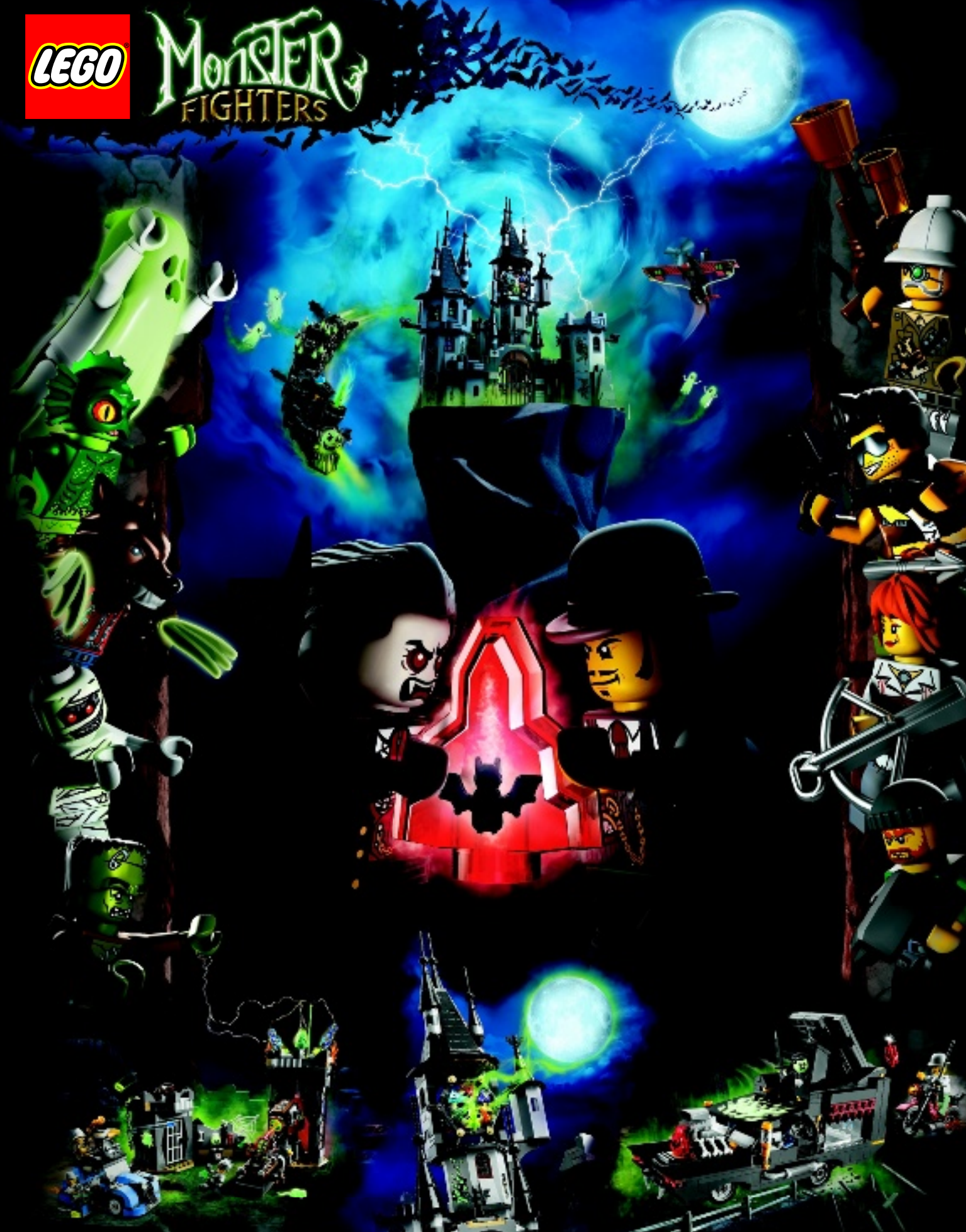



1



club™

FREE\*! GRATIS! GRATUIT!

[www.LEGOclub.com/Max](http://www.LEGOclub.com/Max)

[www.LEGOclub.com/Max](http://www.LEGOclub.com/Max)

2



3



\*Paid subscription in Australia and New Zealand.

\*Abonnement payant en Australie et Nouvelle-Zélande.

LEGO and the LEGO logo are trademarks of the/ sont des marques de commerce de/son marcas registradas de LEGO Group. ©2012 The LEGO Group.

[www.LEGO.com](http://www.LEGO.com)

6030855 / 6030865

©2012 The LEGO Group.





# MONSTER FIGHTERS

10228





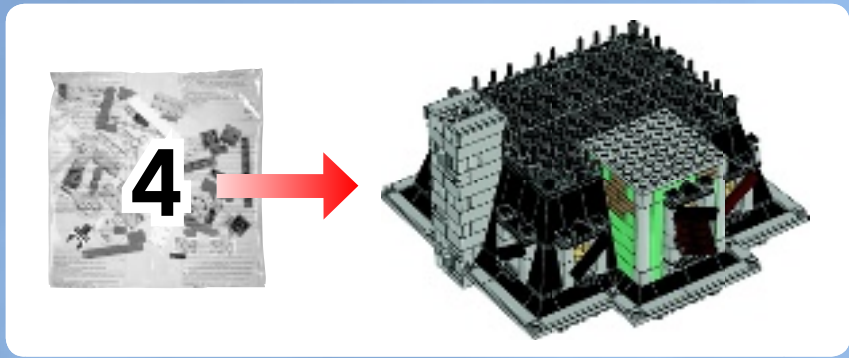

94

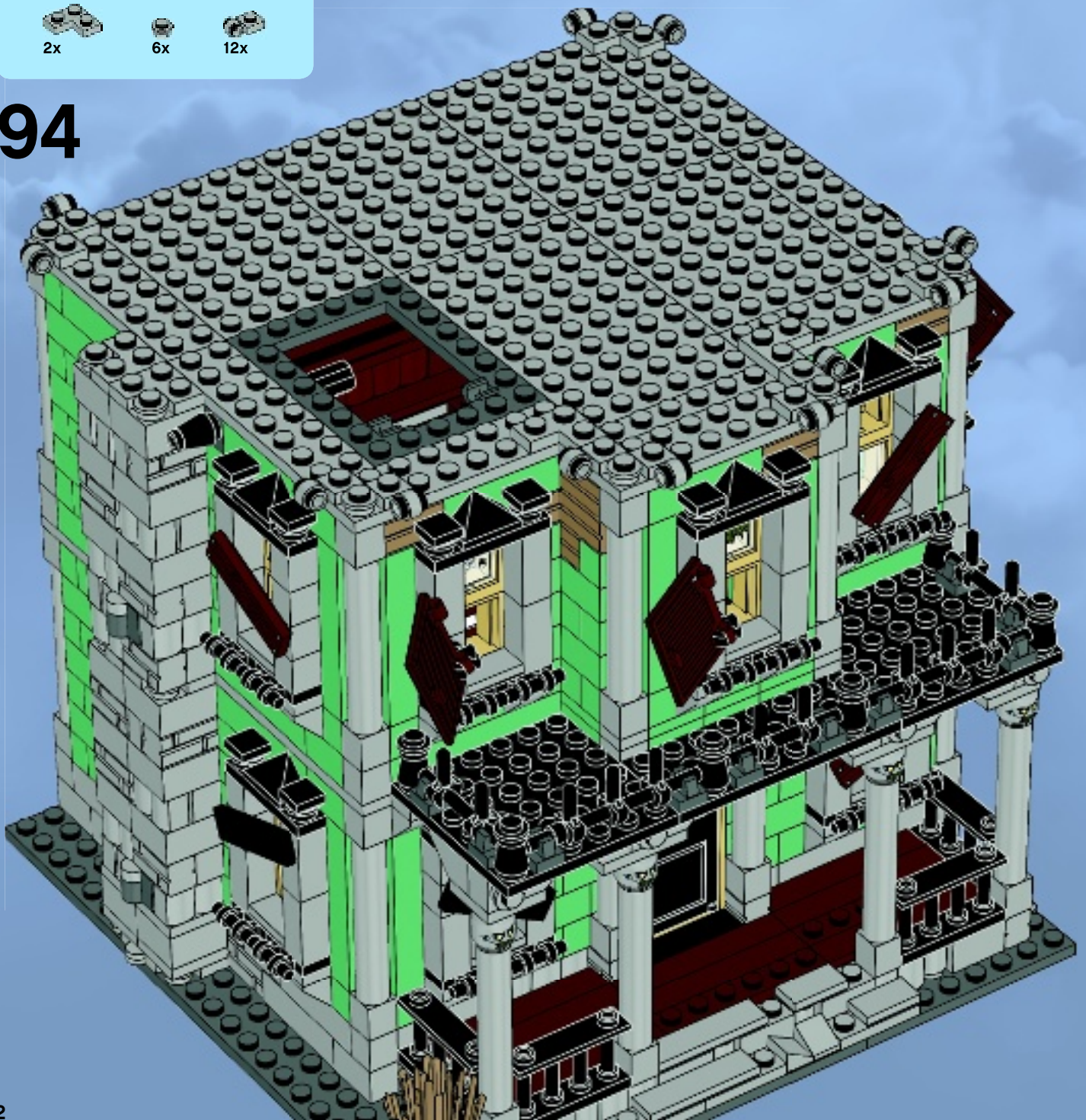





27x

# 95

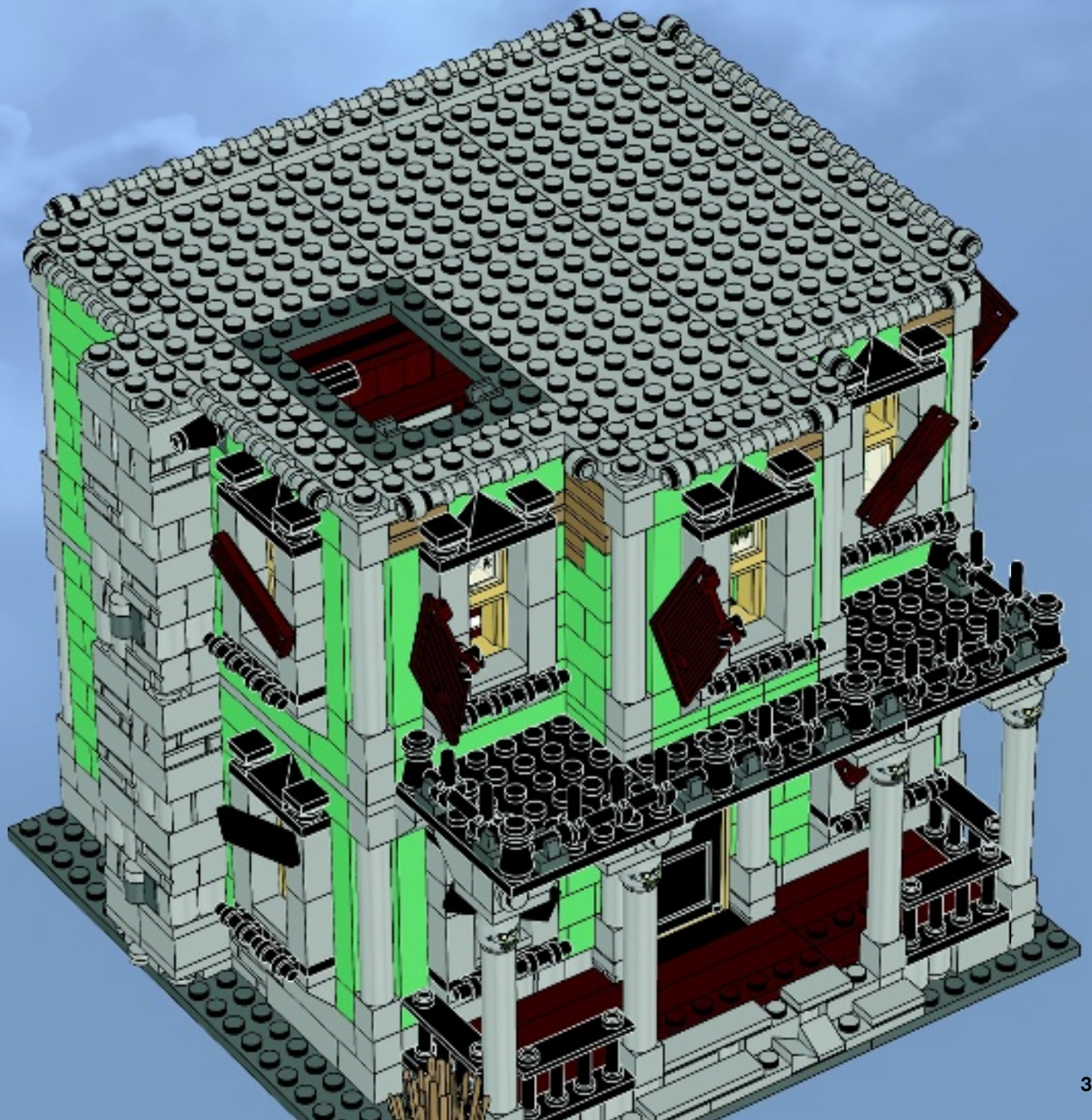



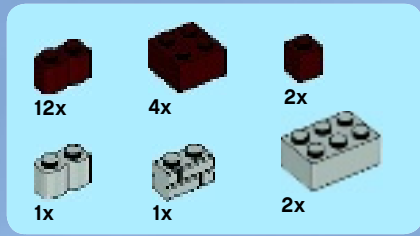

96

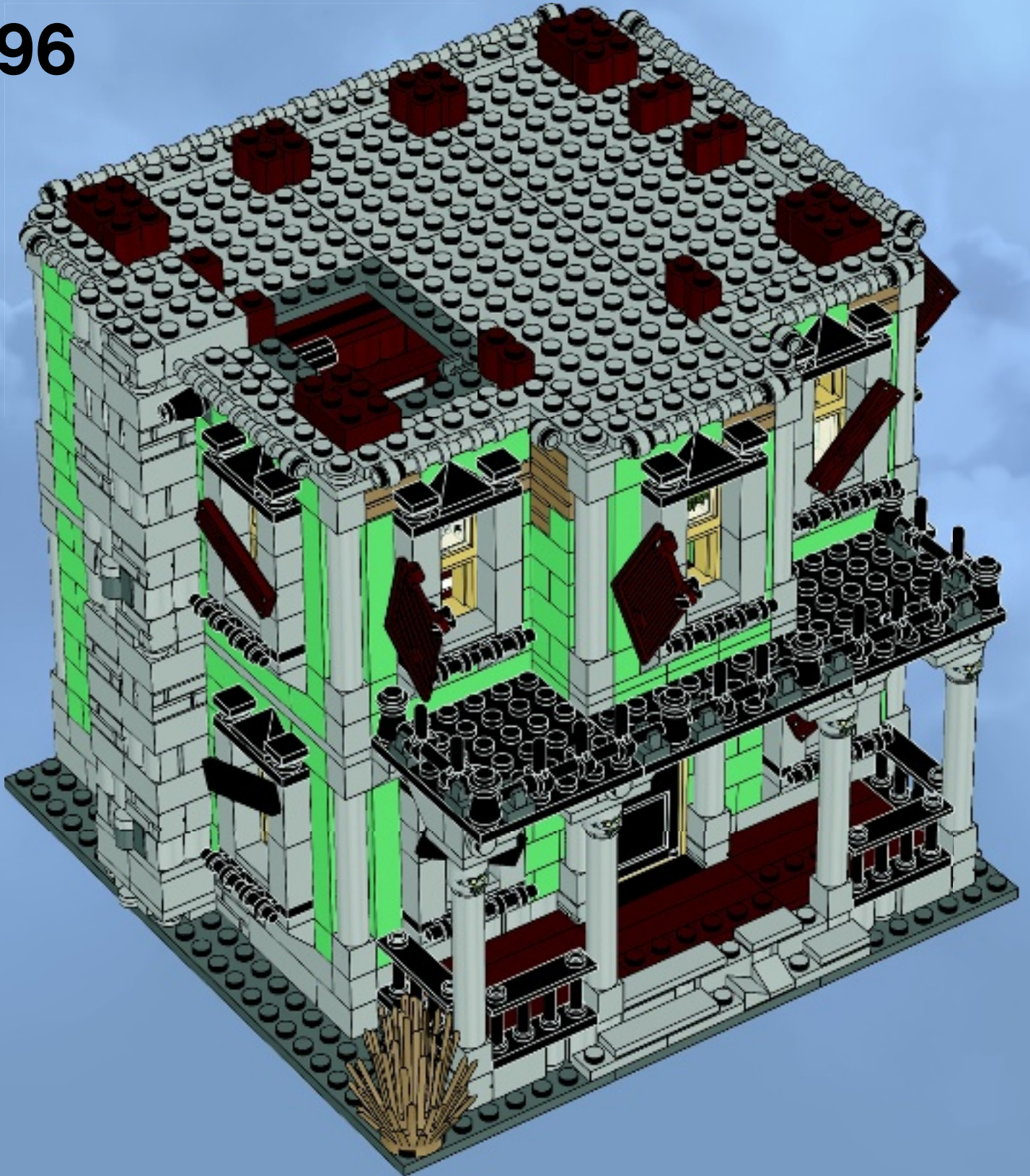



1x

1



4x

2



4x

3

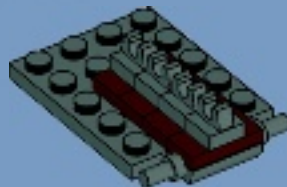



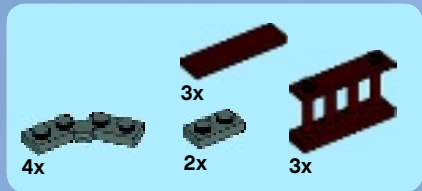

# 4

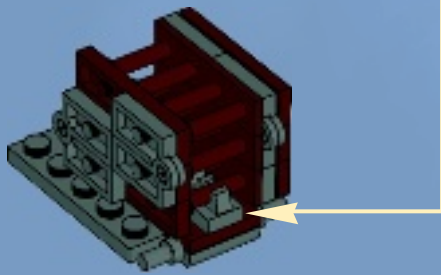
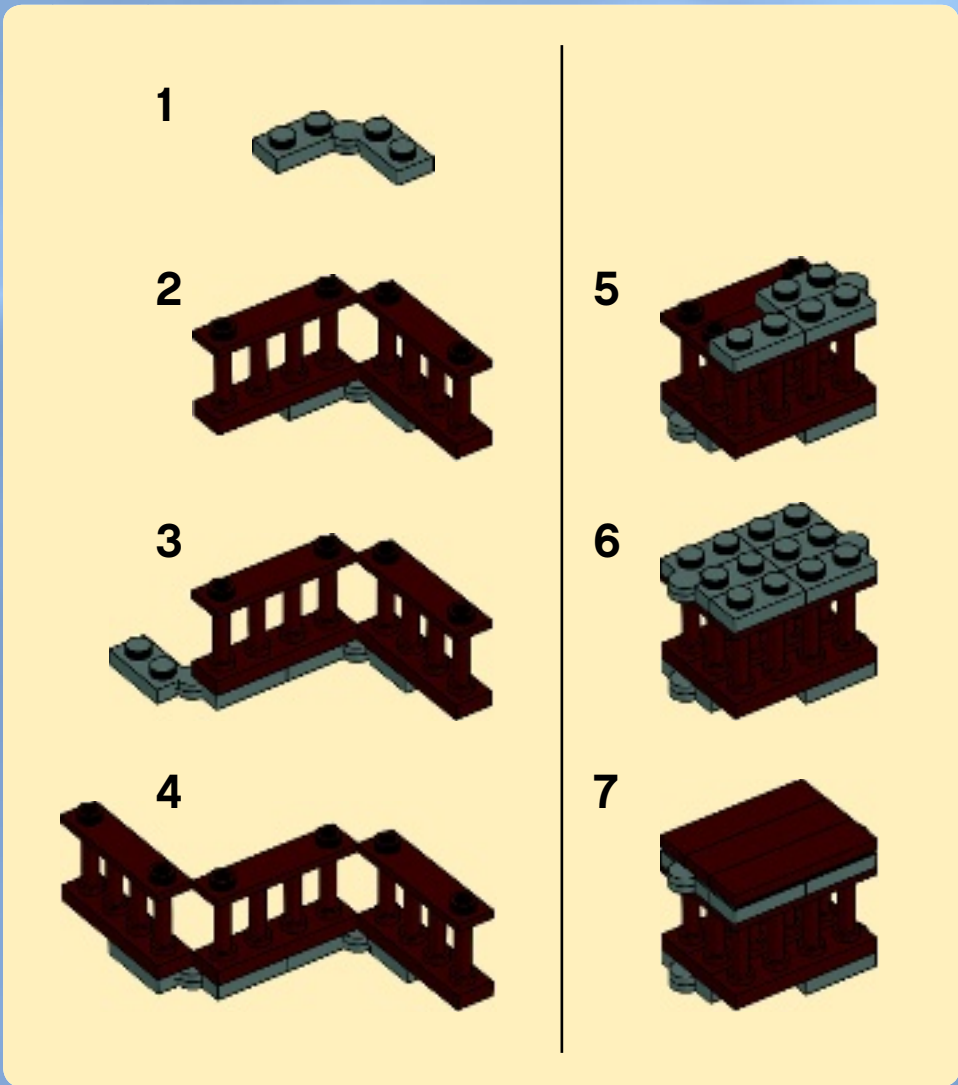

97

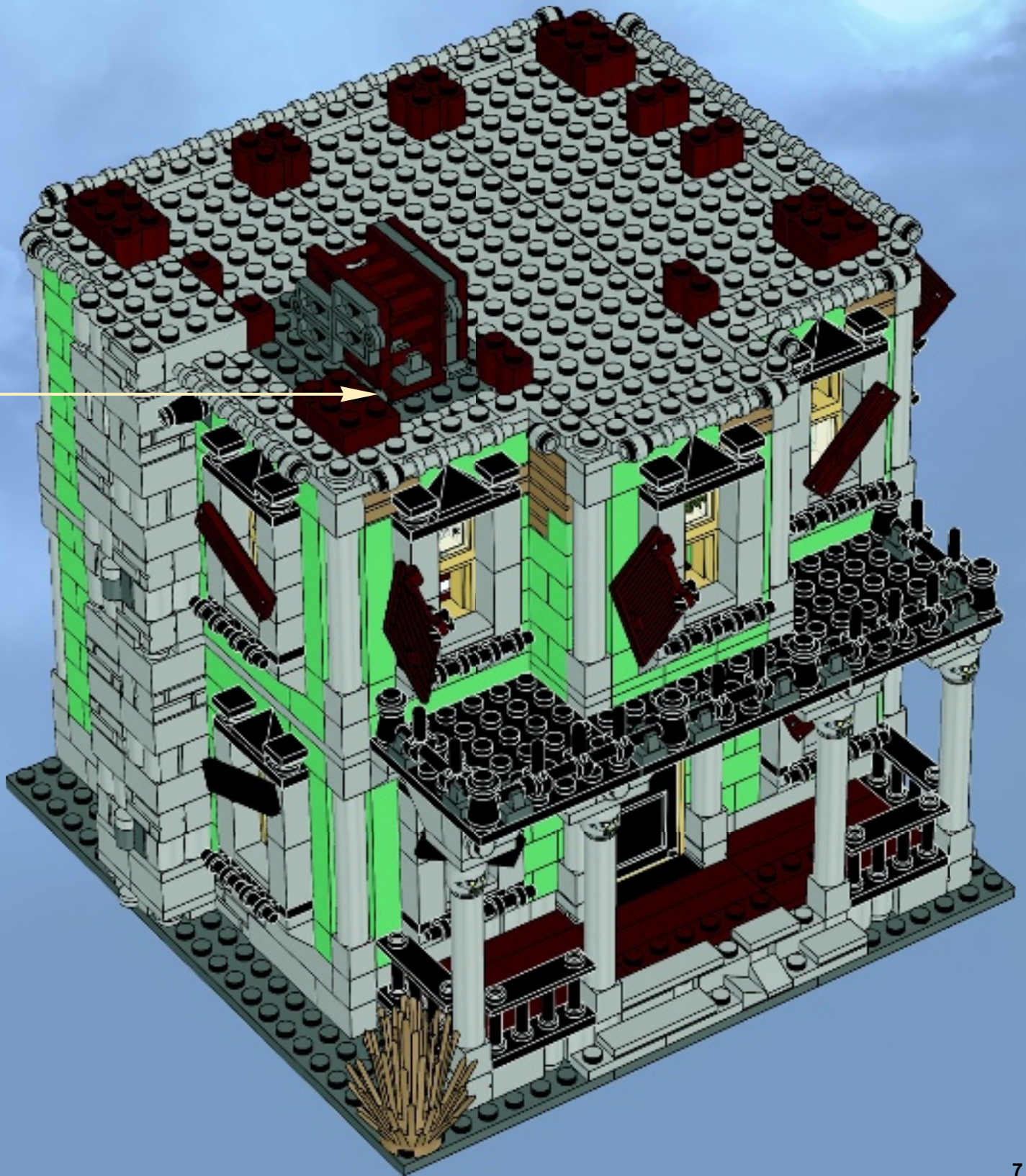



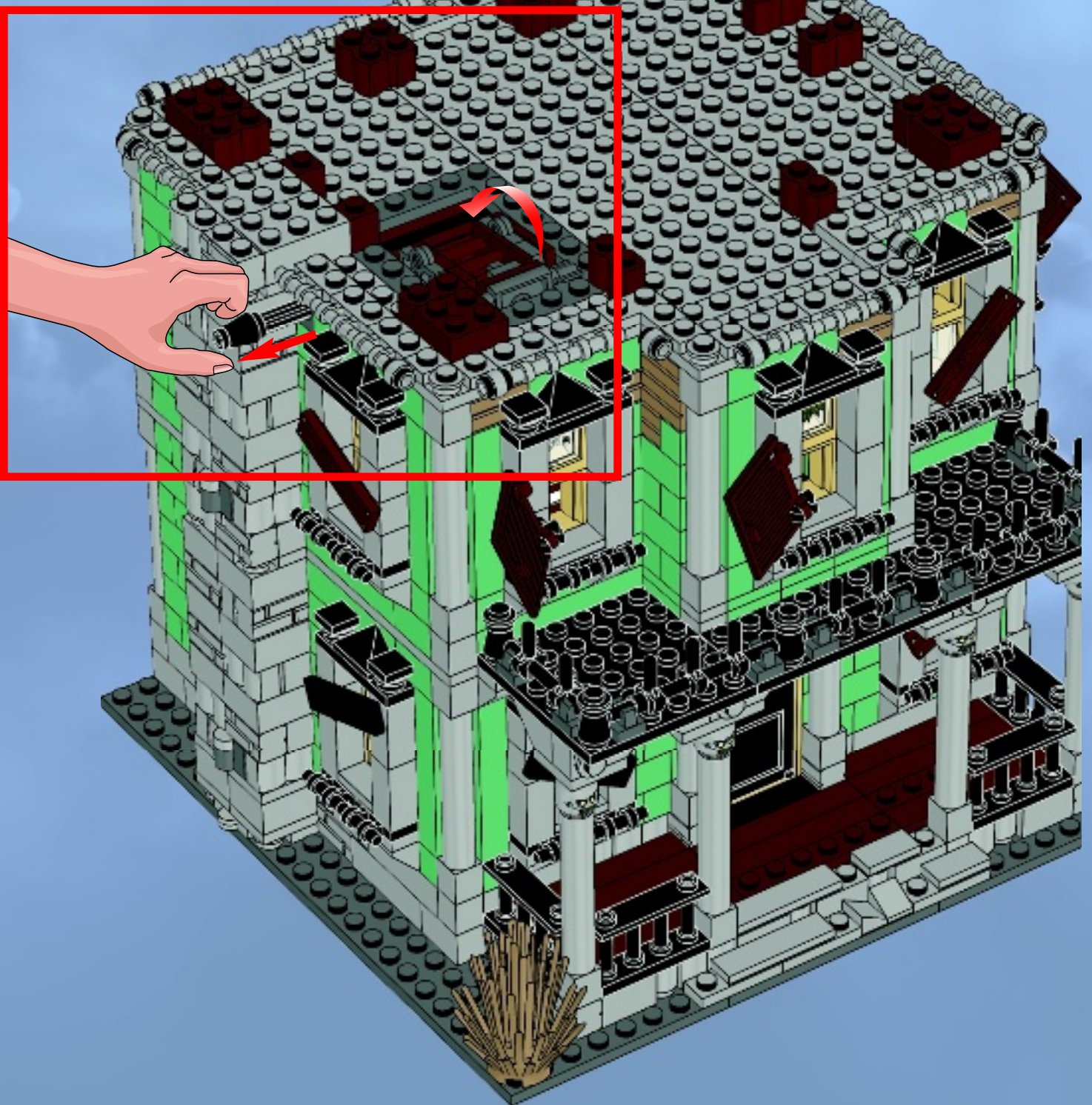



99

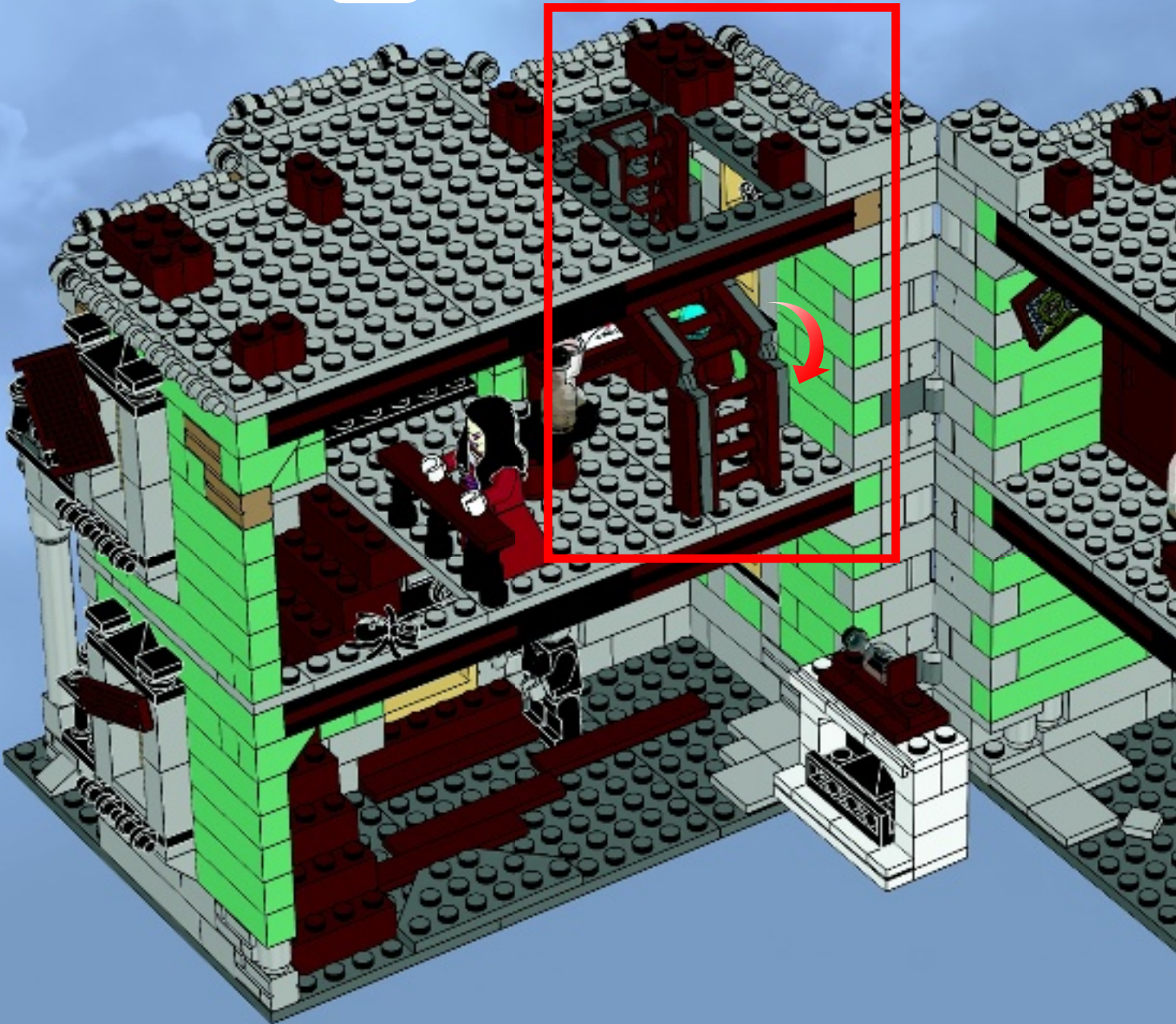





2x



6x



28x





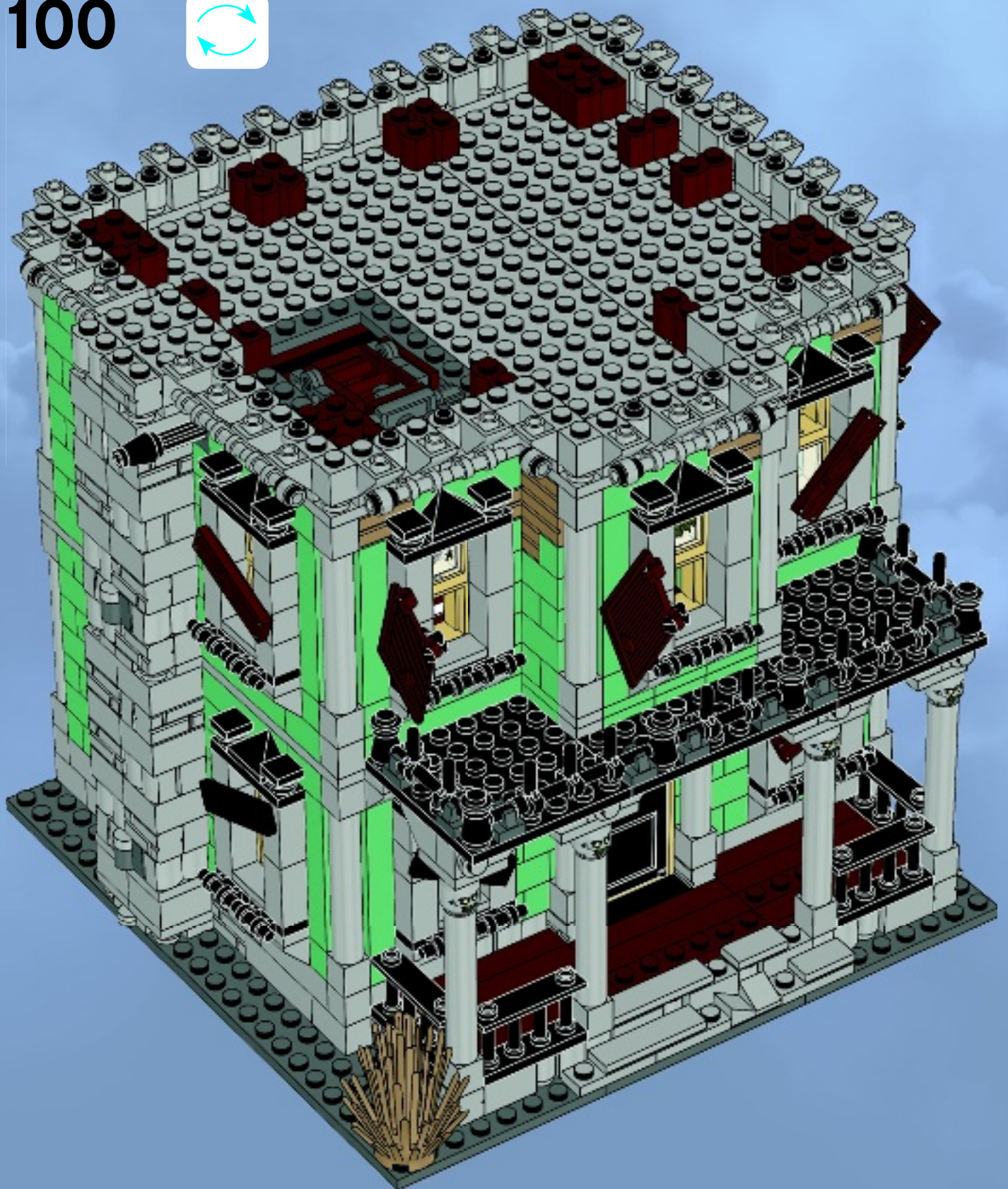

38x

# 100





	
4x	2x
	
7x	3x

# 101

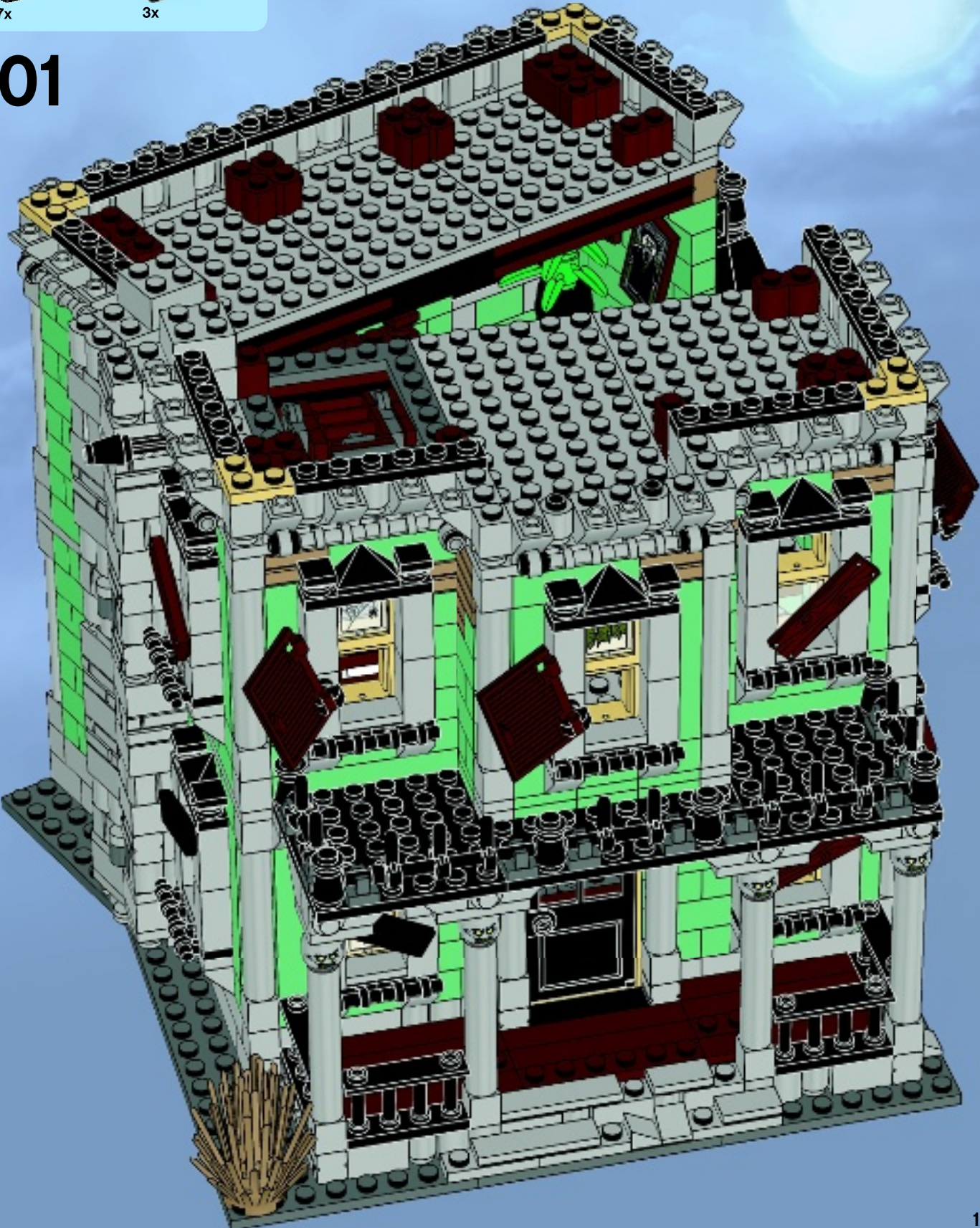



102

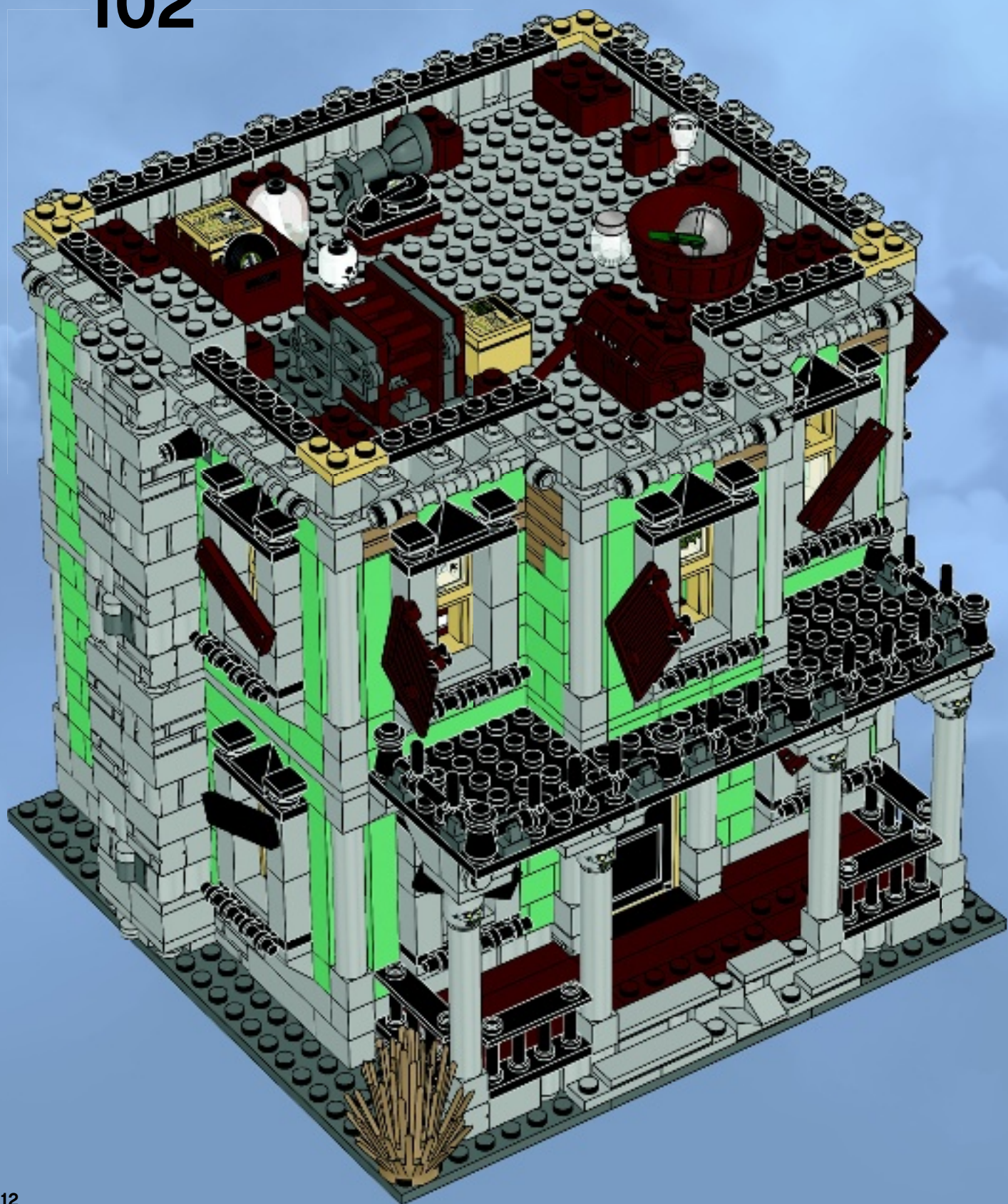





12x



4x



2x

# 103

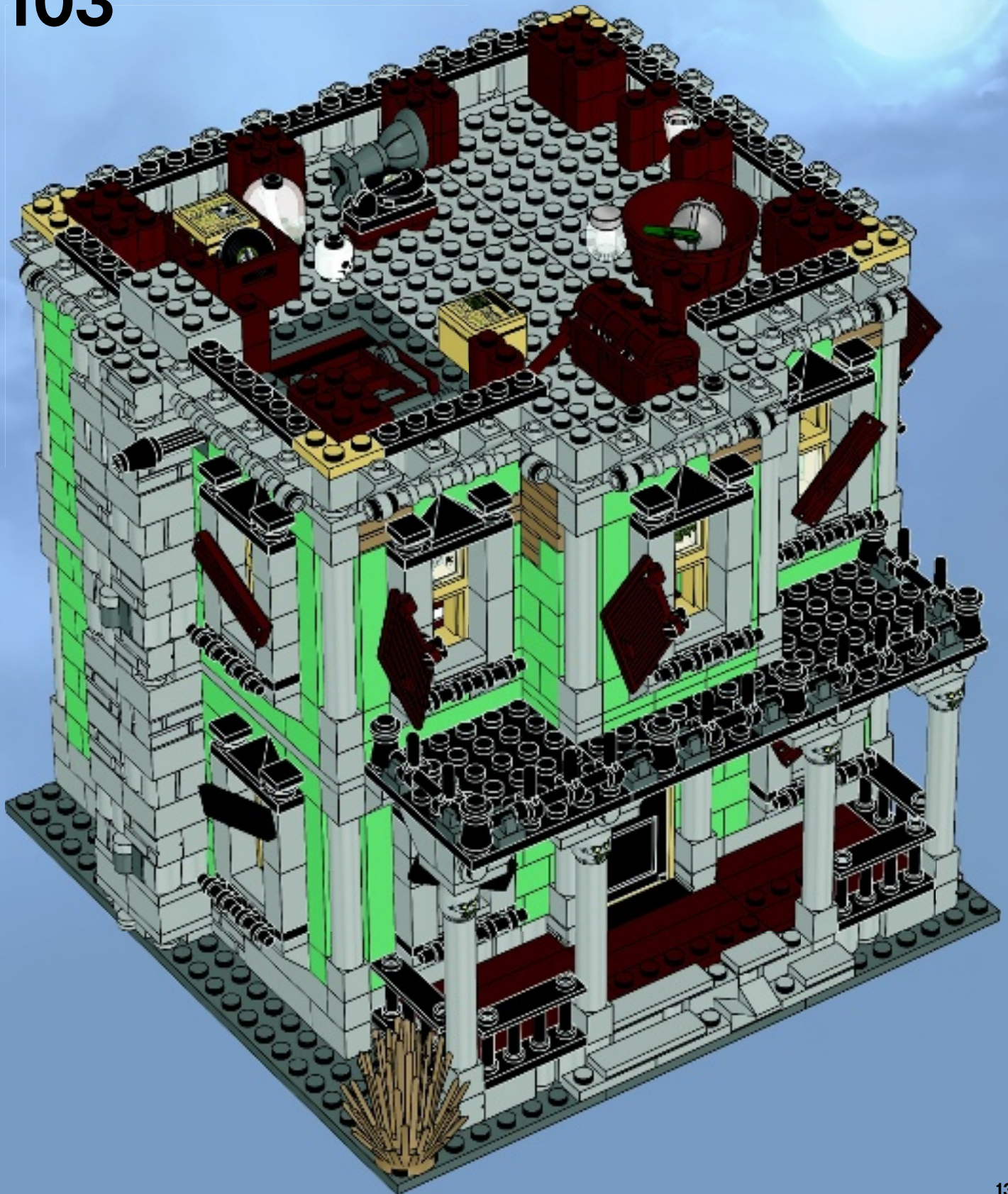



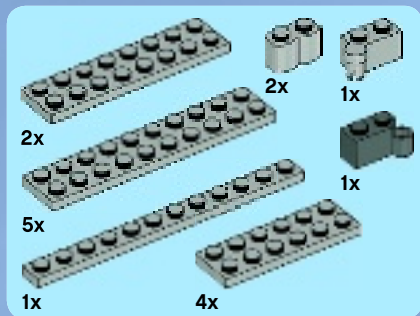

# 104

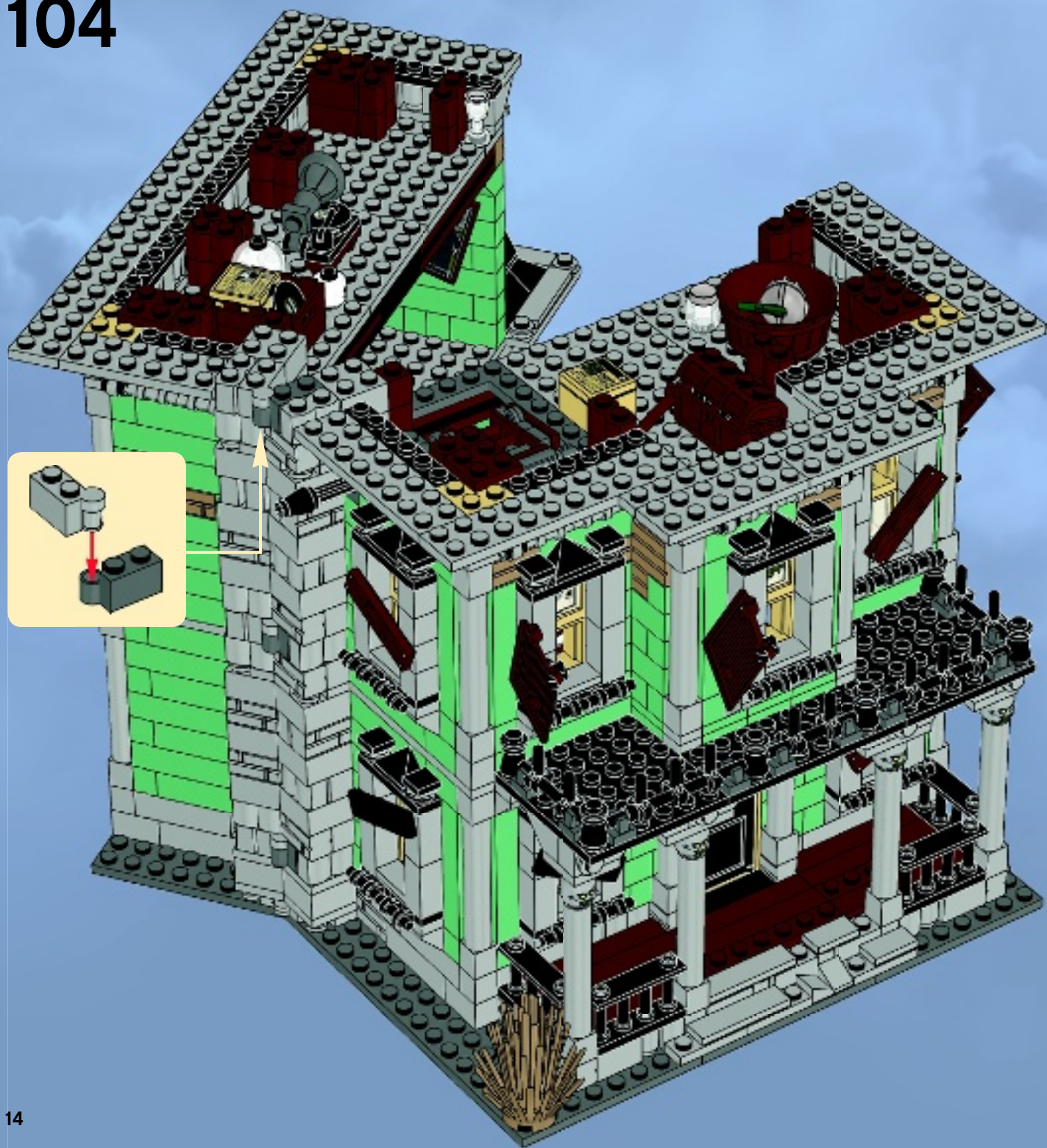





12x



4x



6x



6x



2x



2x

# 105





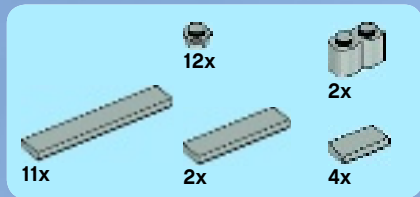

# 106

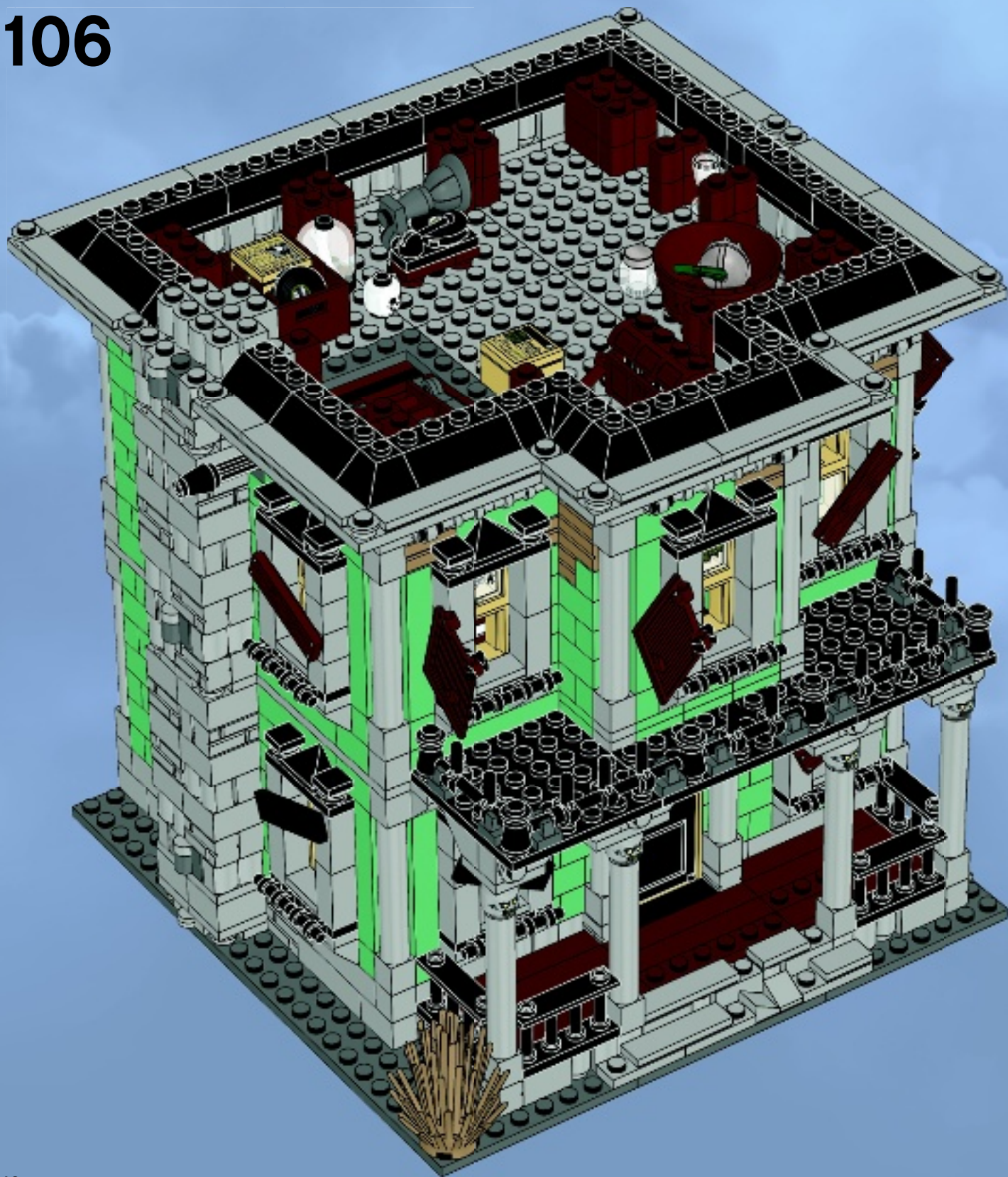



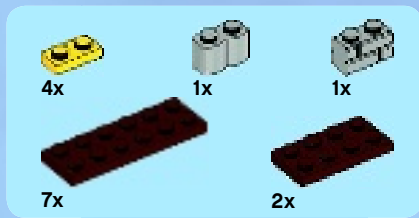

# 107

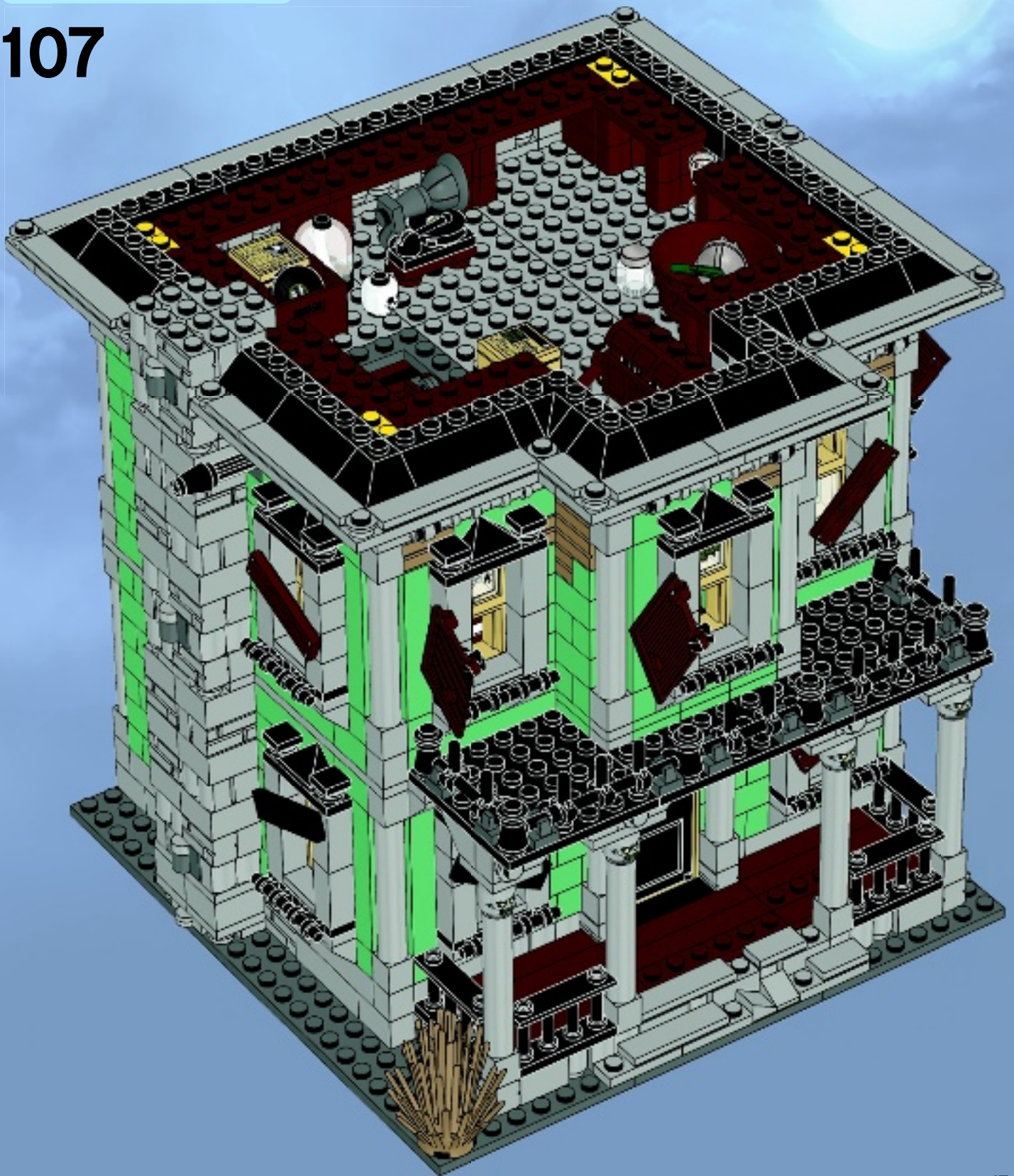





4x



7x

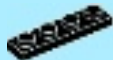

2x

# 108

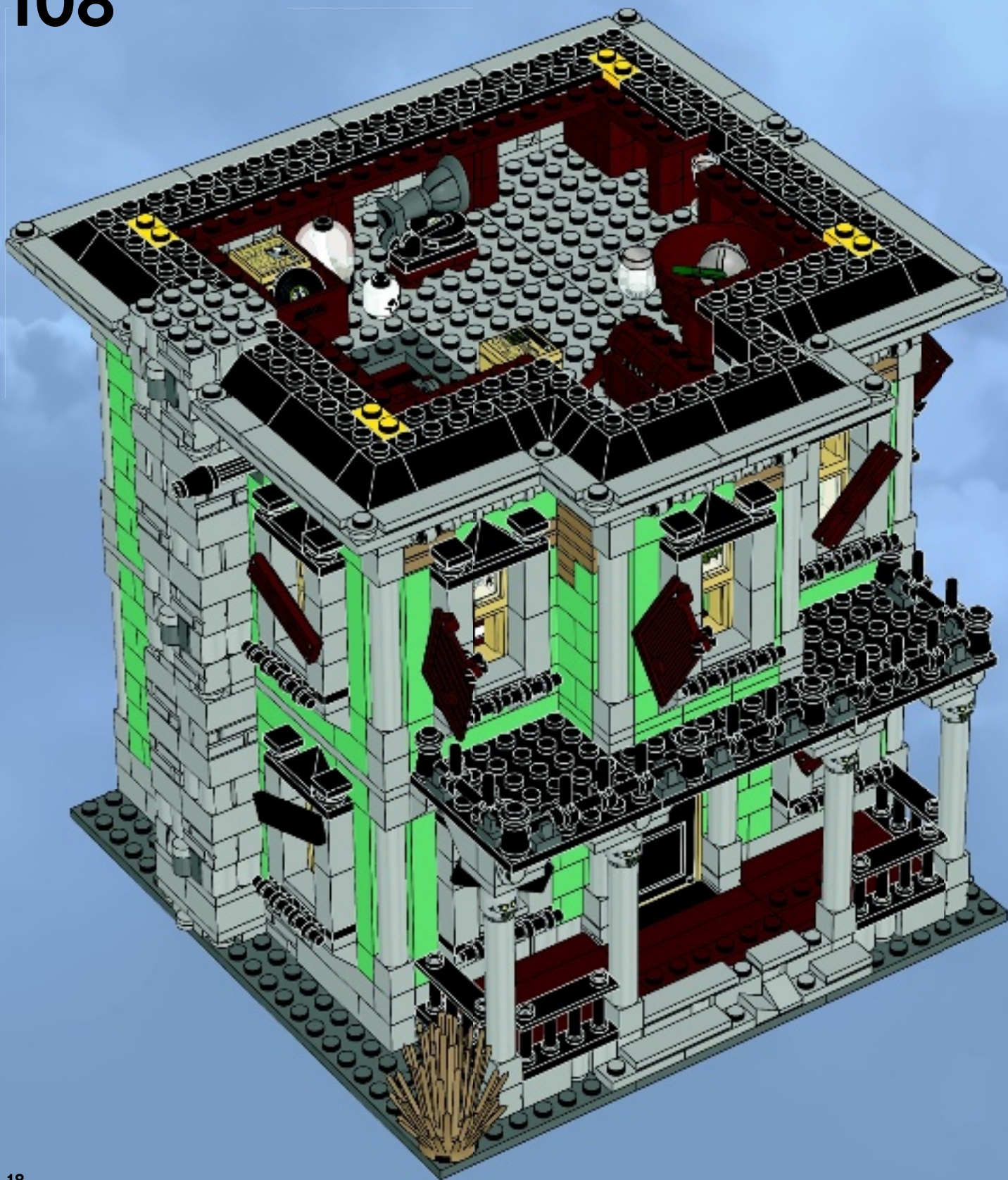





2x



6x



6x

# 109







5x



5x

# 110

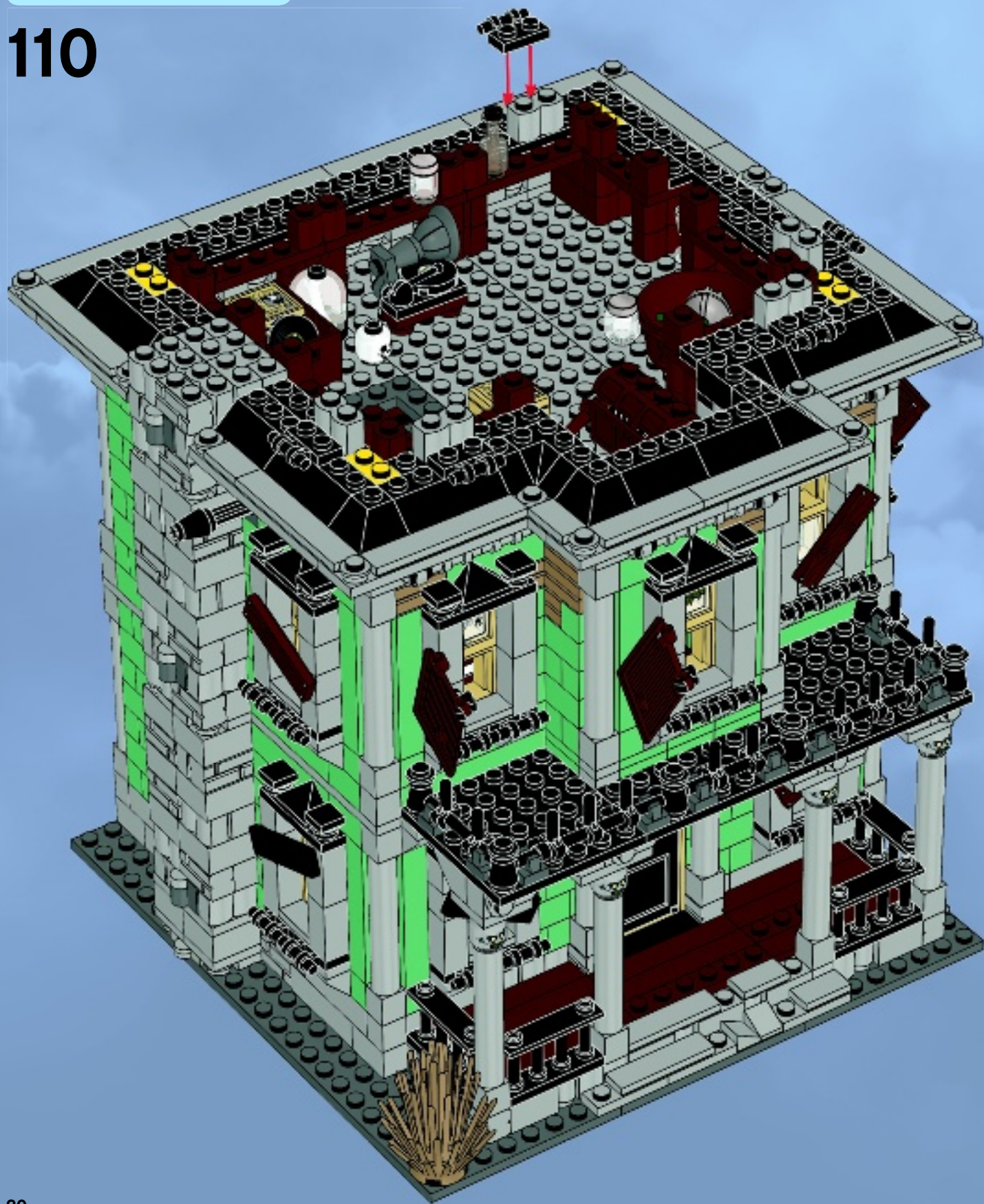





6x



6x

# 111

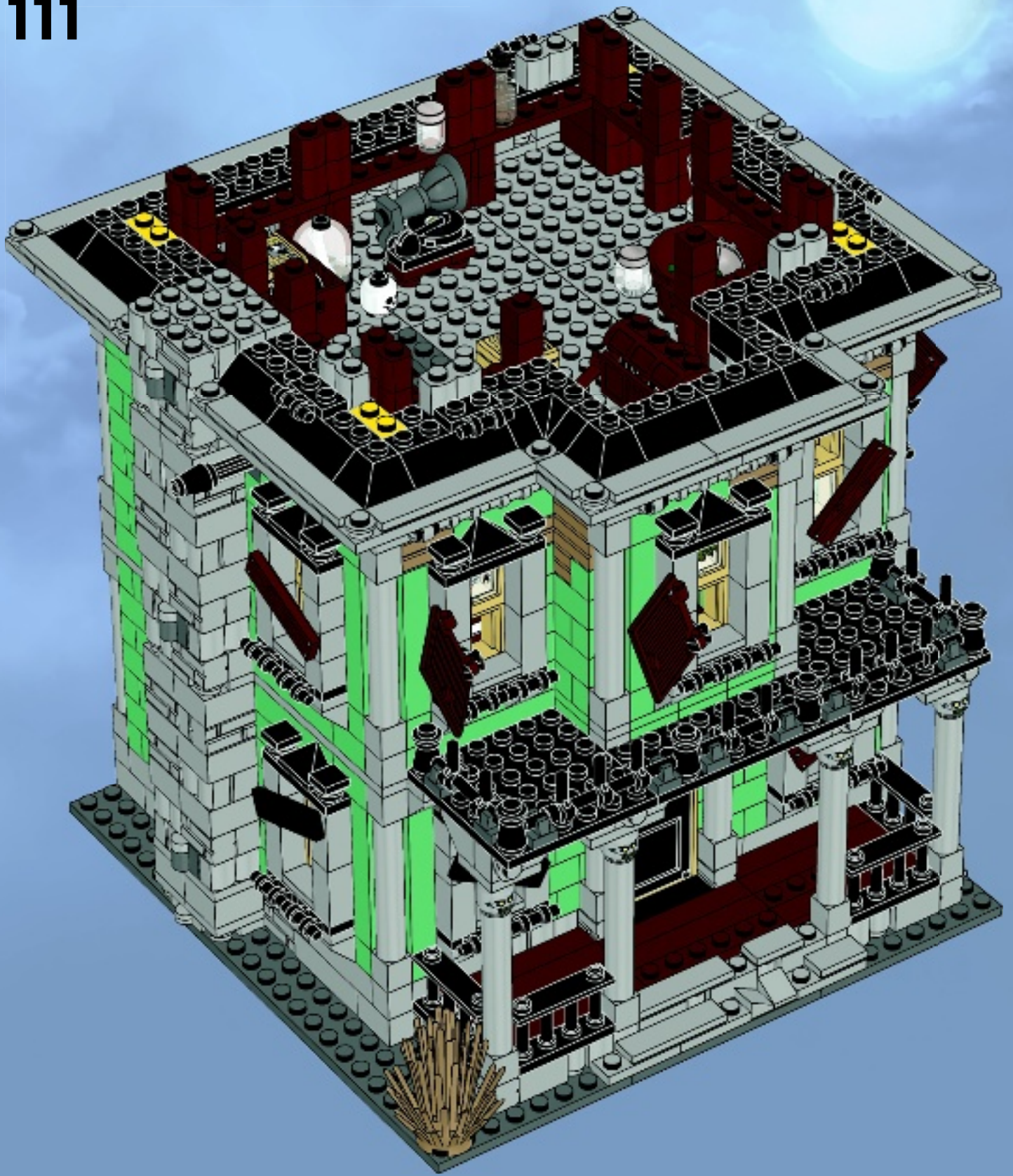



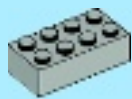

2x



5x



2x



2x



2x



1x

# 112

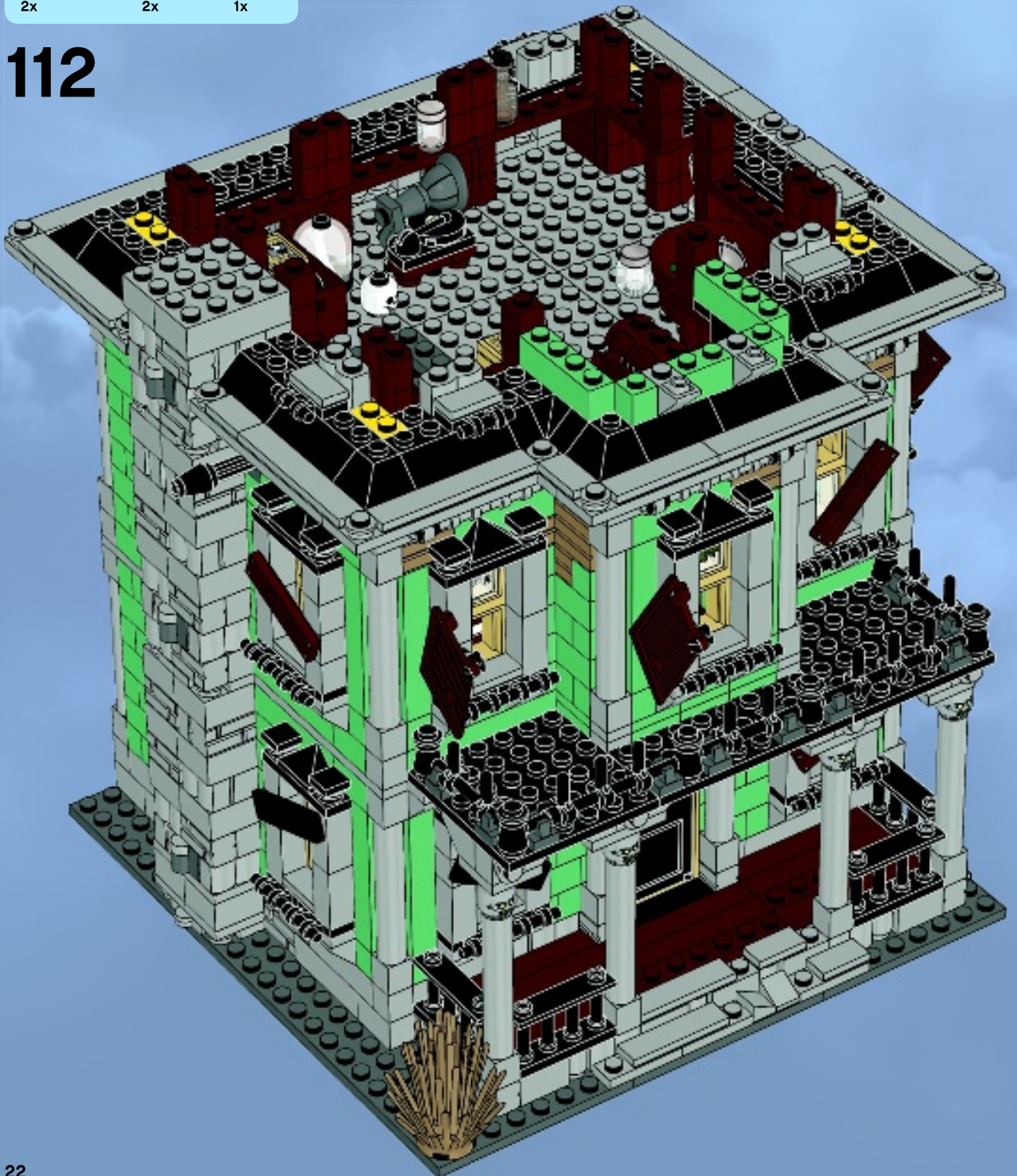



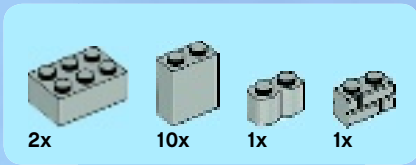

# 113

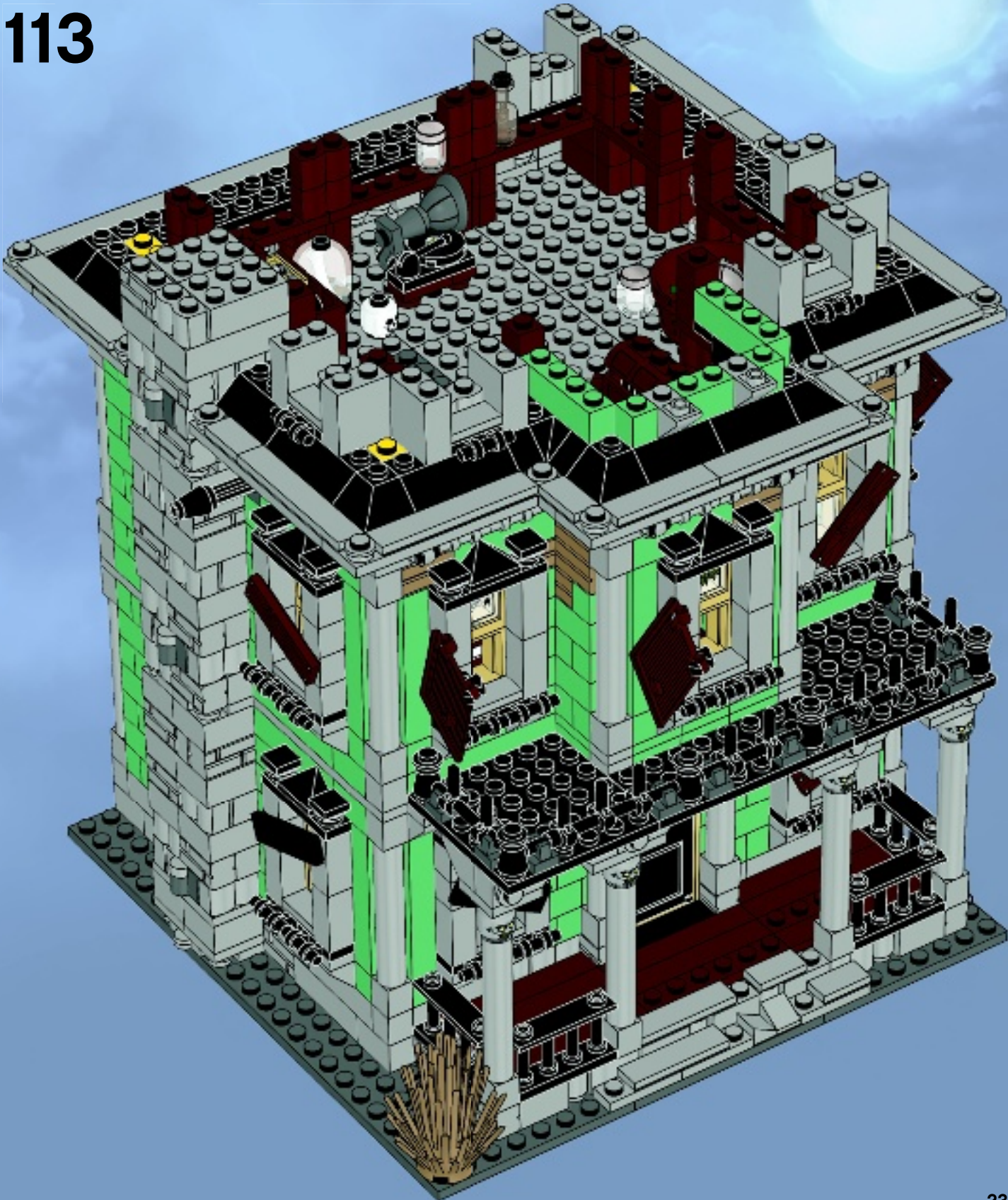





2x



4x



15x

# 114

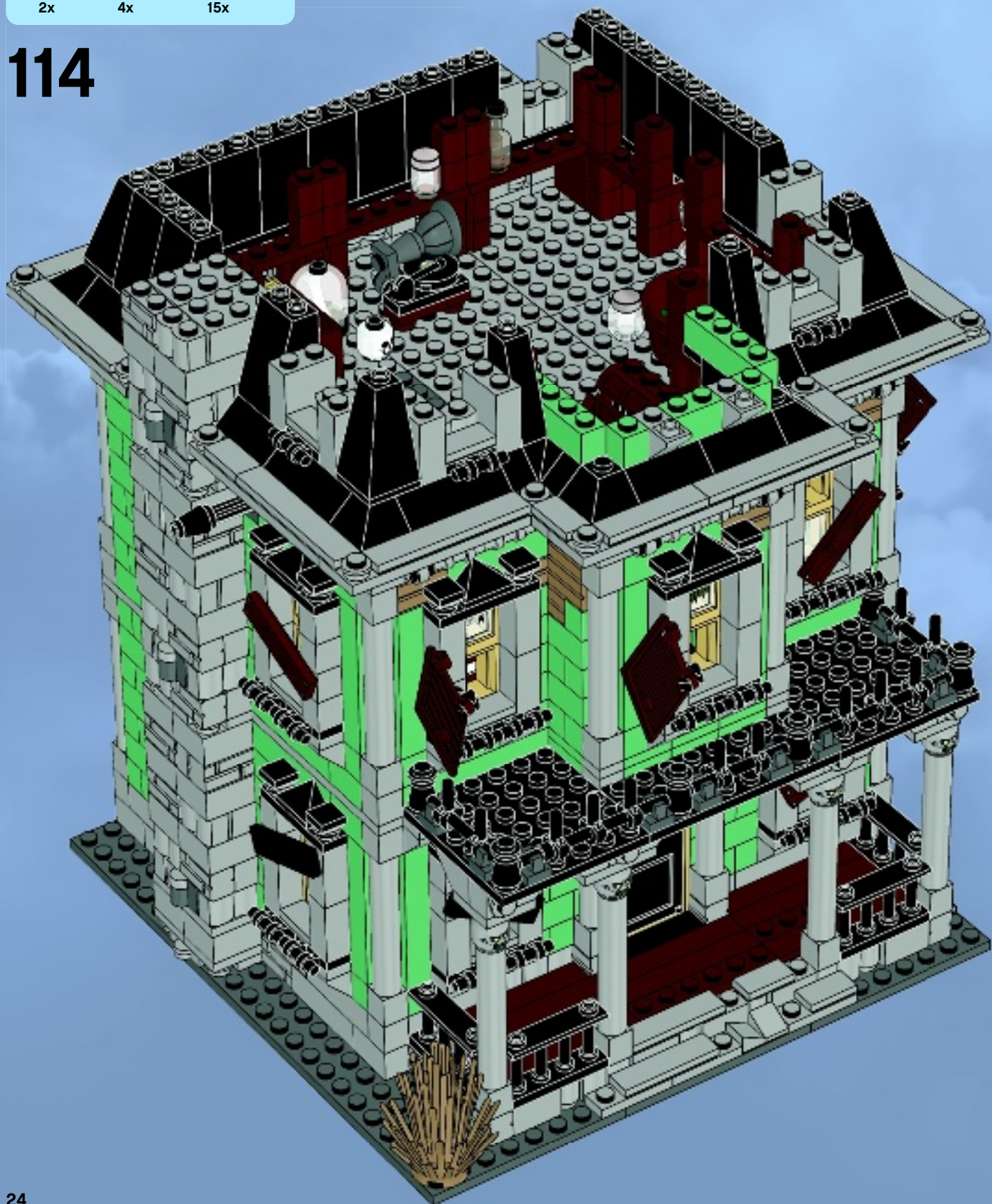





6x



6x

# 115

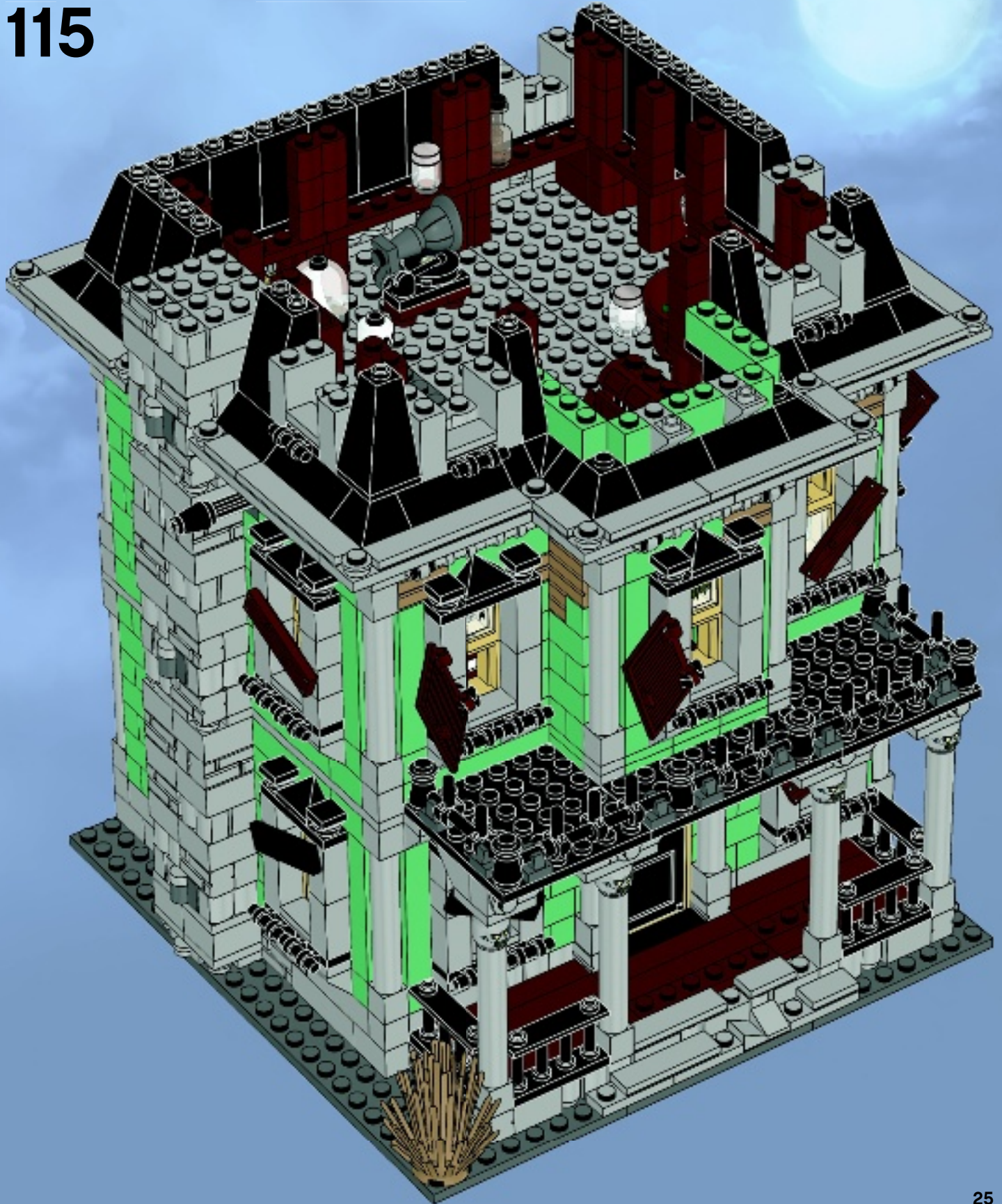



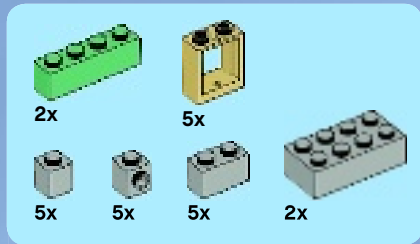

116

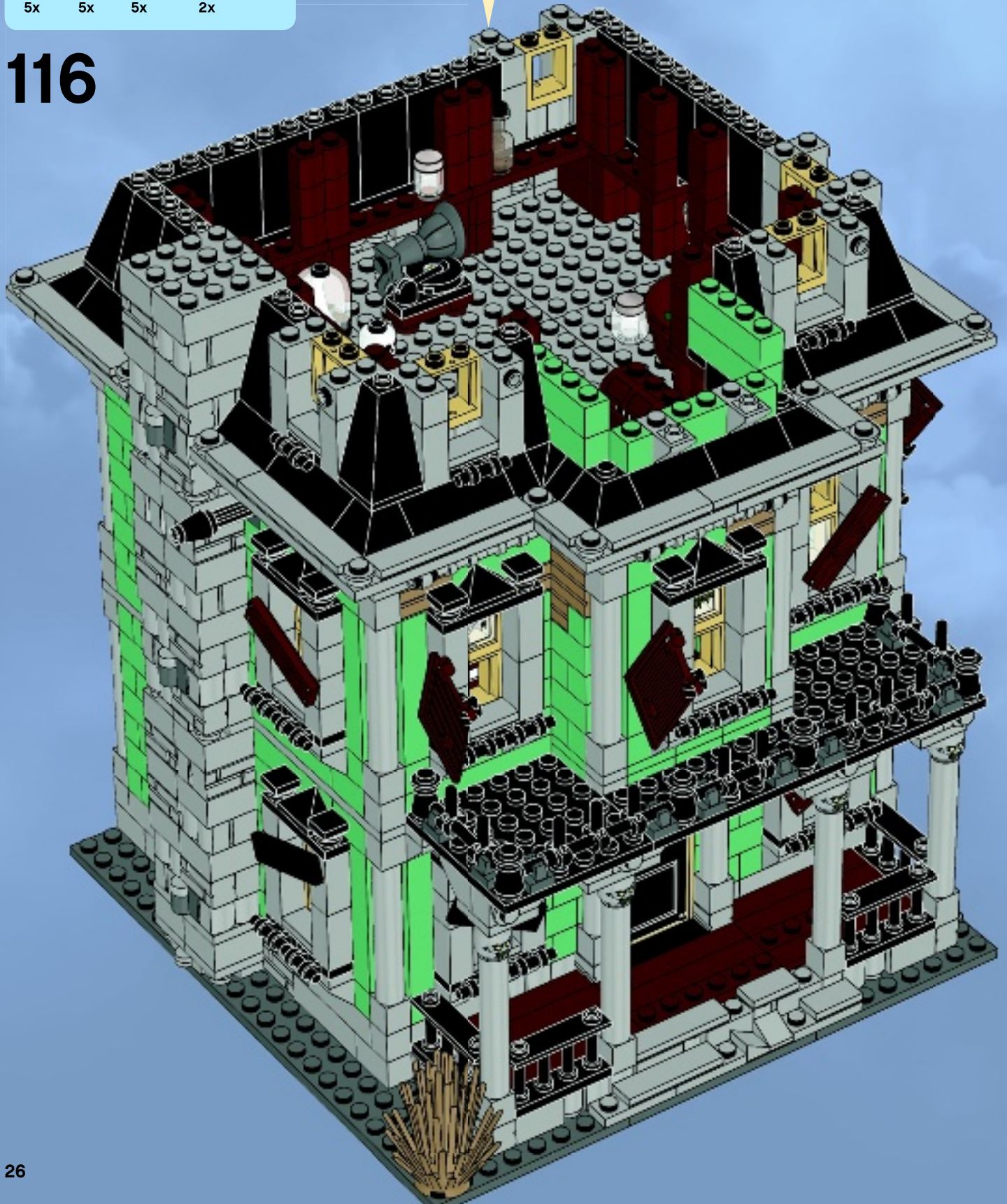



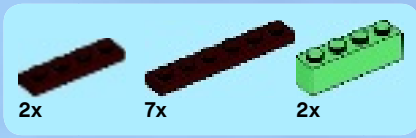



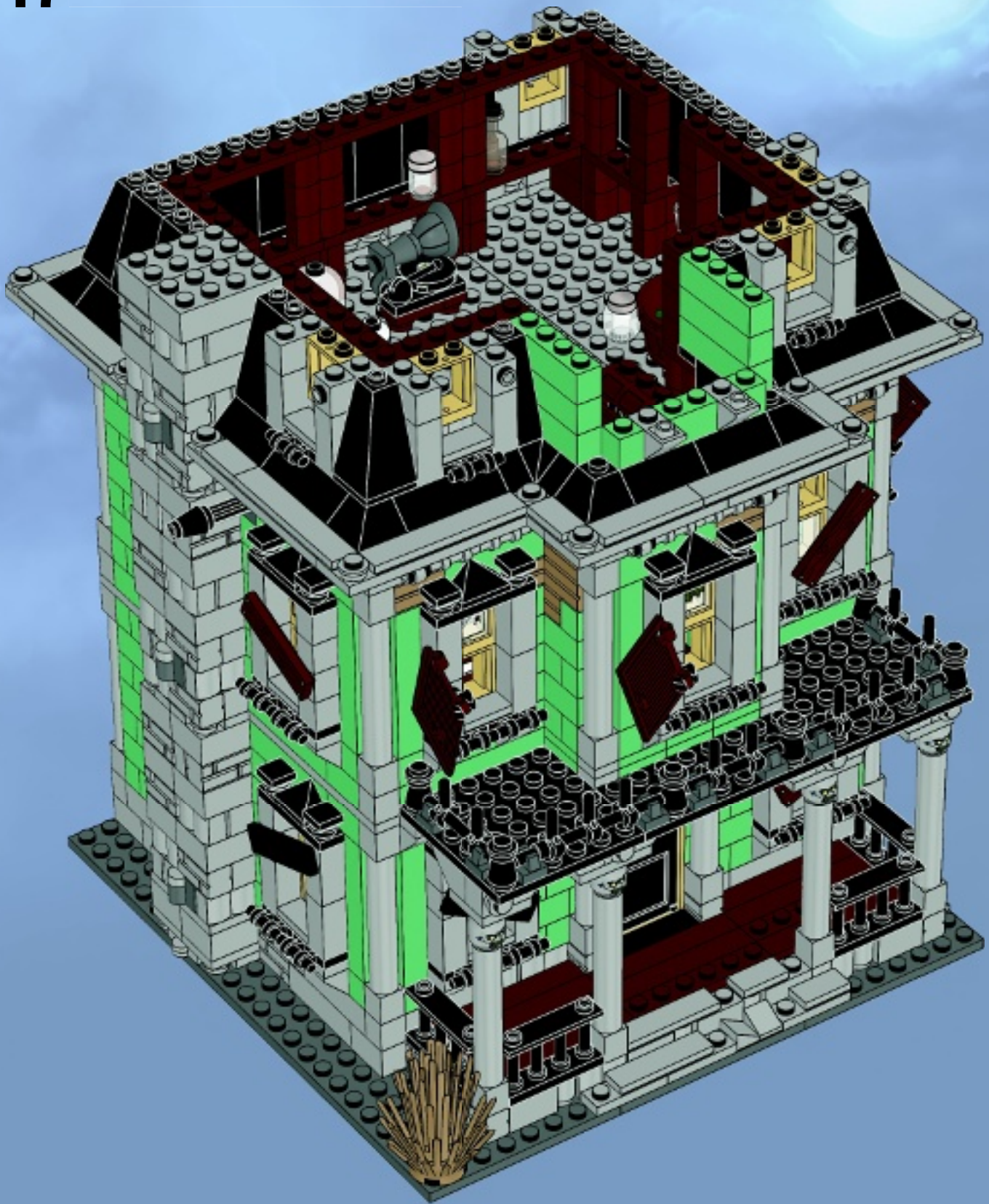

117





 5x  
 10x  
 5x  
 10x

**1** 
     
 **2** 
     
 **3** 
     
 **5x**

# 118

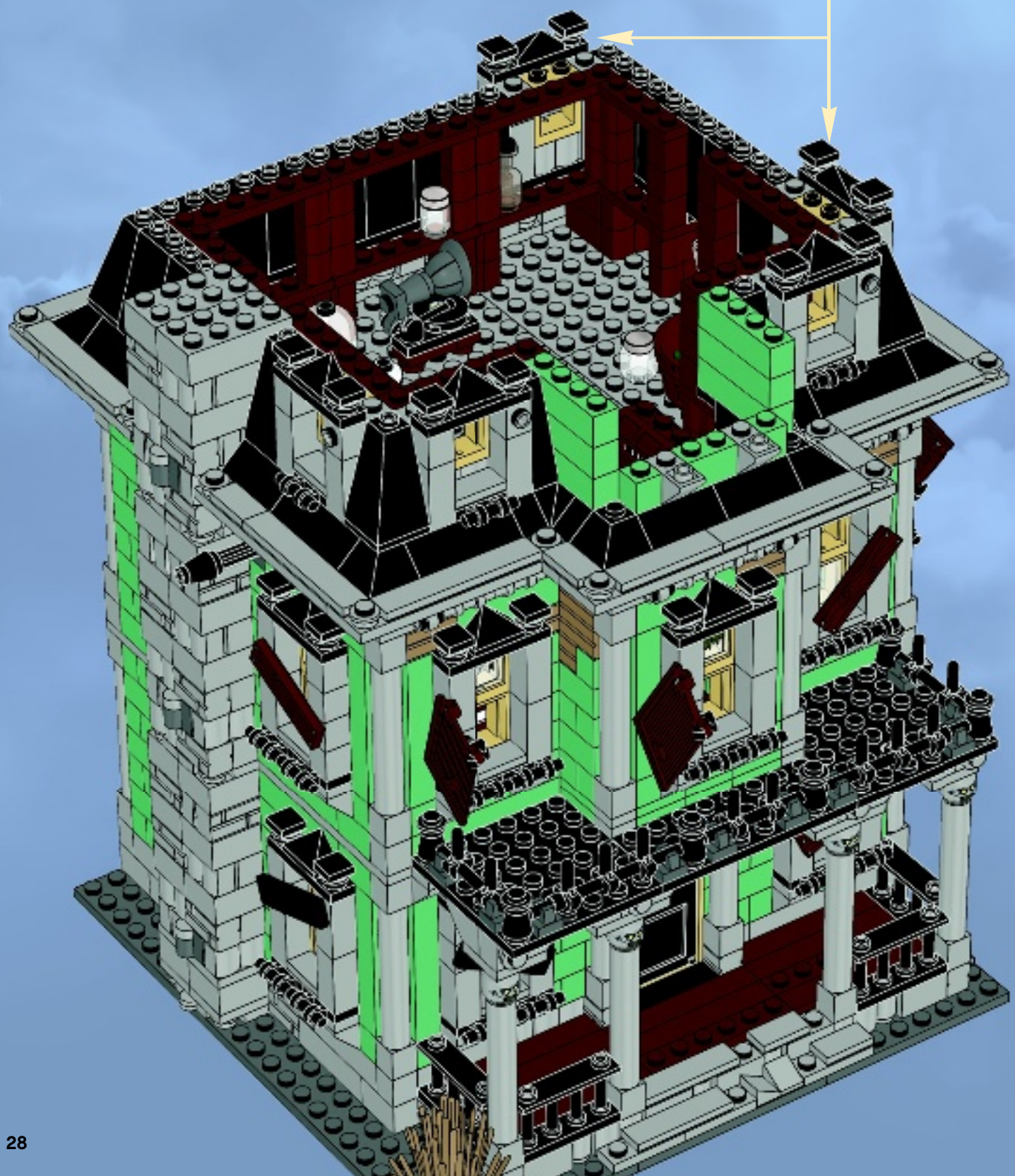



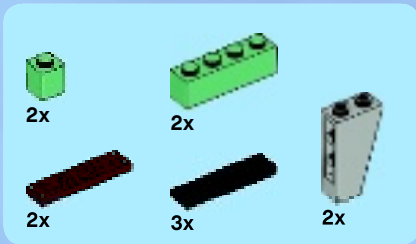

119

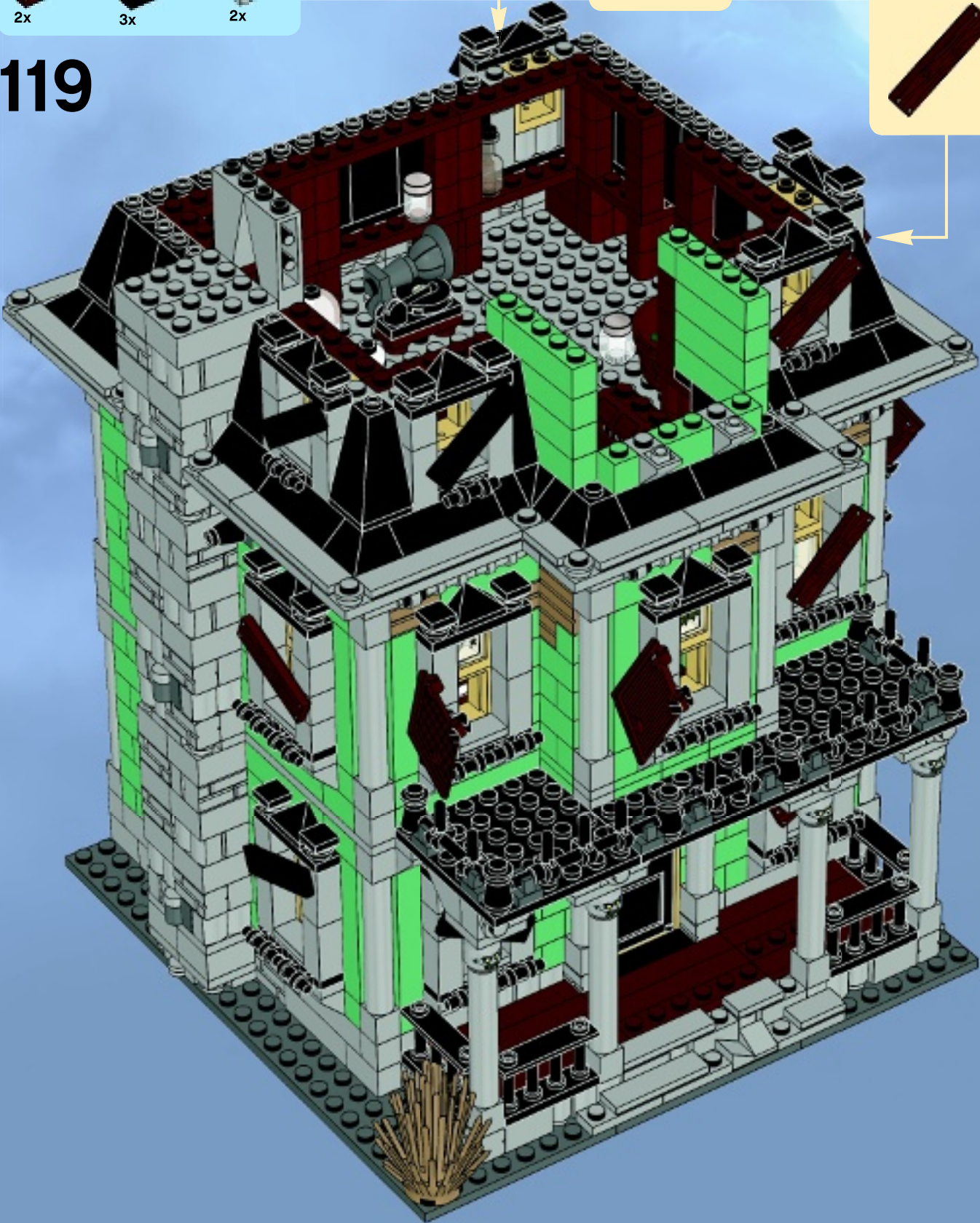



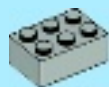

2x



2x



2x



4x

# 120

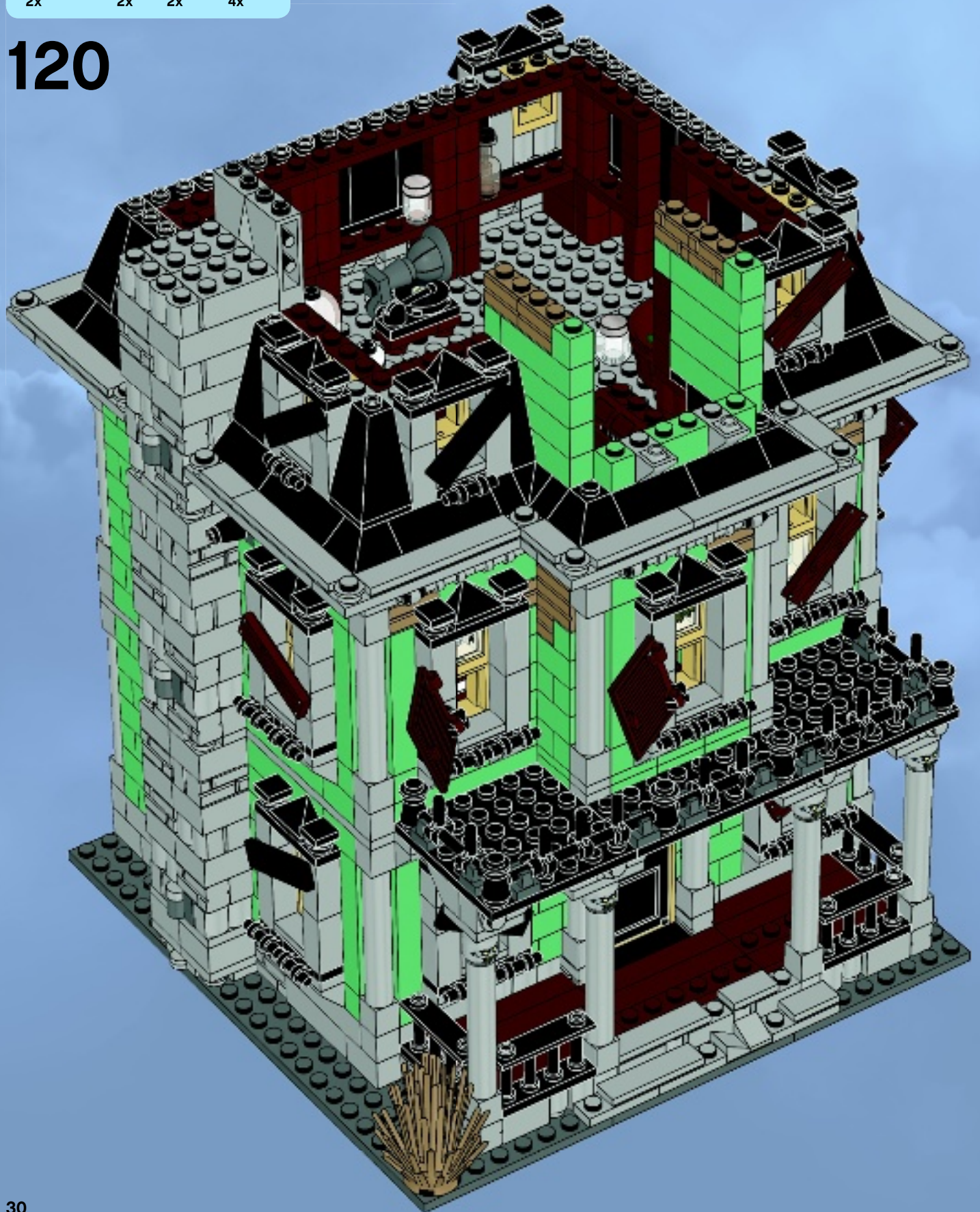





2x



2x



15x



# 121

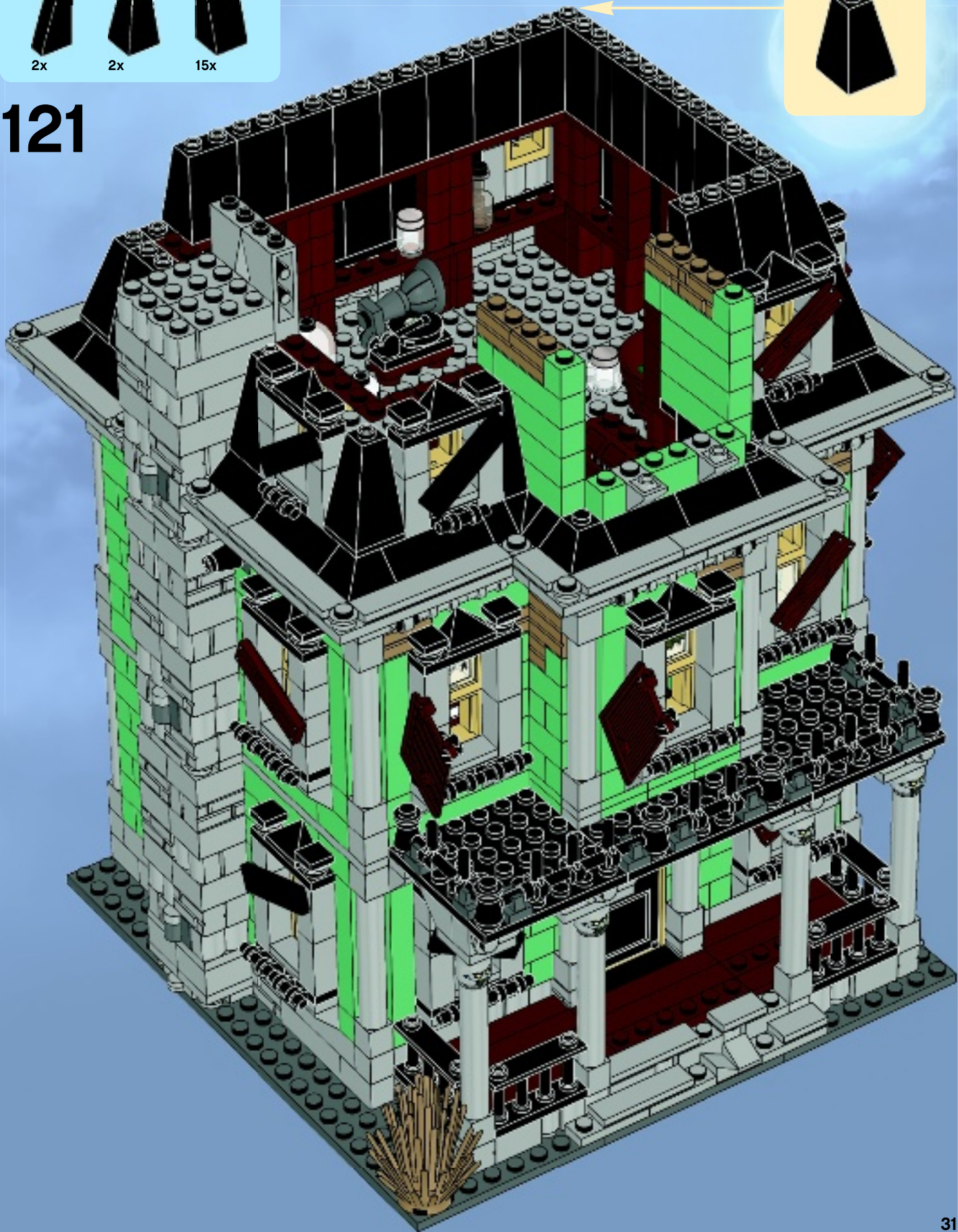



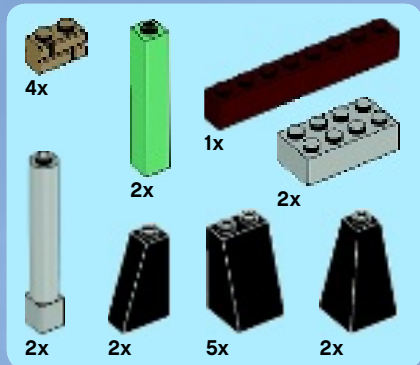

122

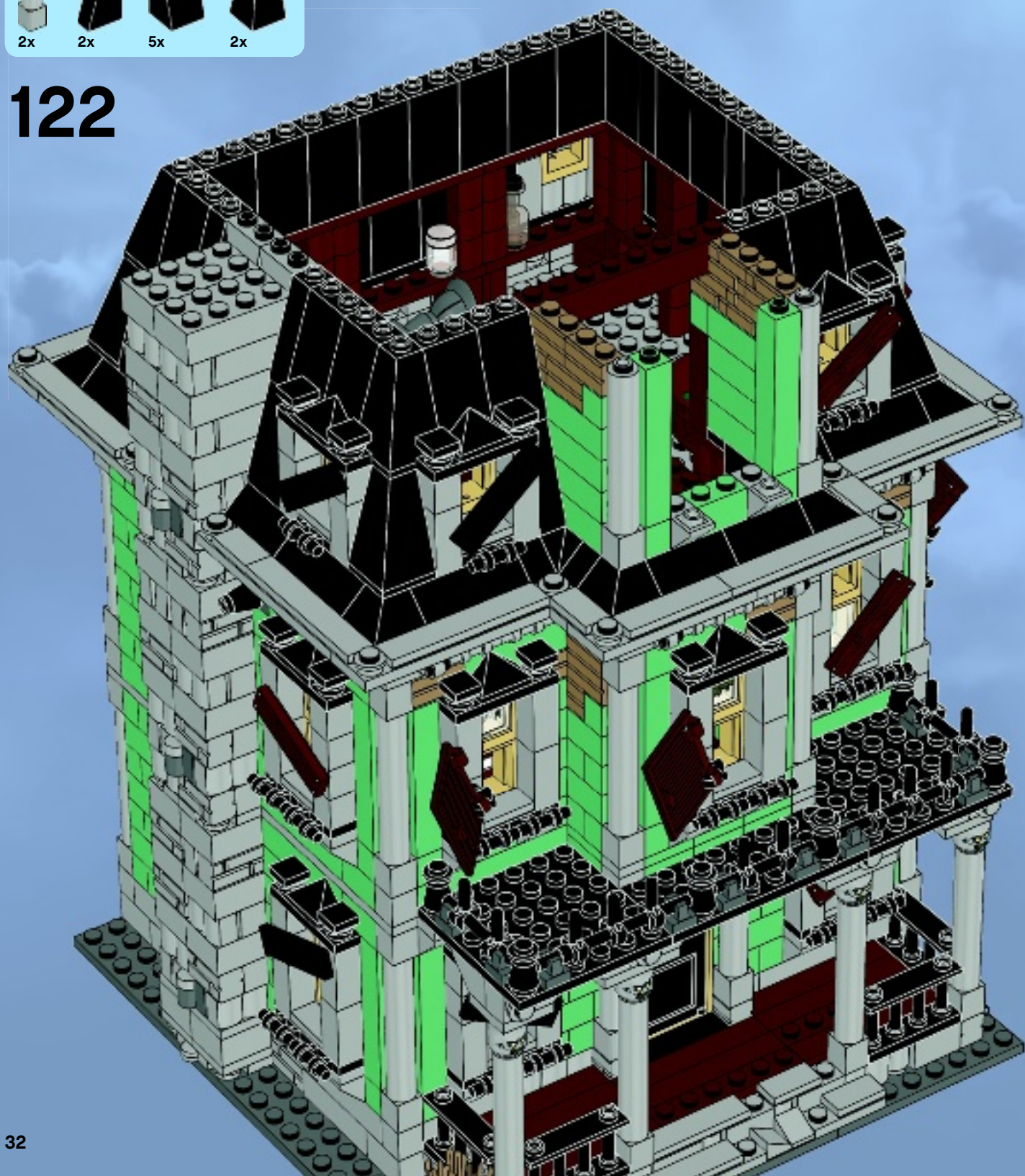



1x

1

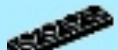
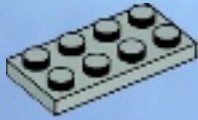

1x



2x

2



1x



1x



1x



1x

3

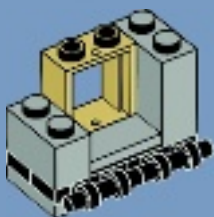

2x

4

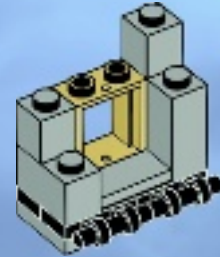

2x

5

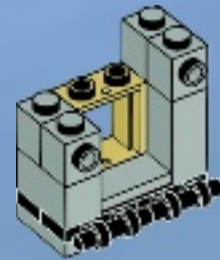

1x



1x



1x

6

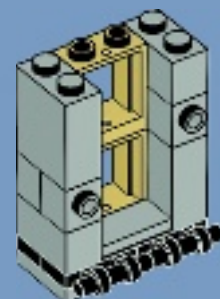



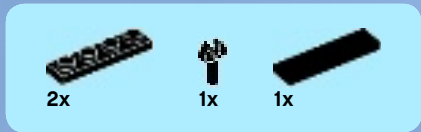

7



8

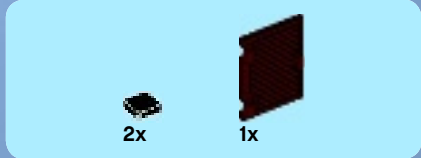

9



123

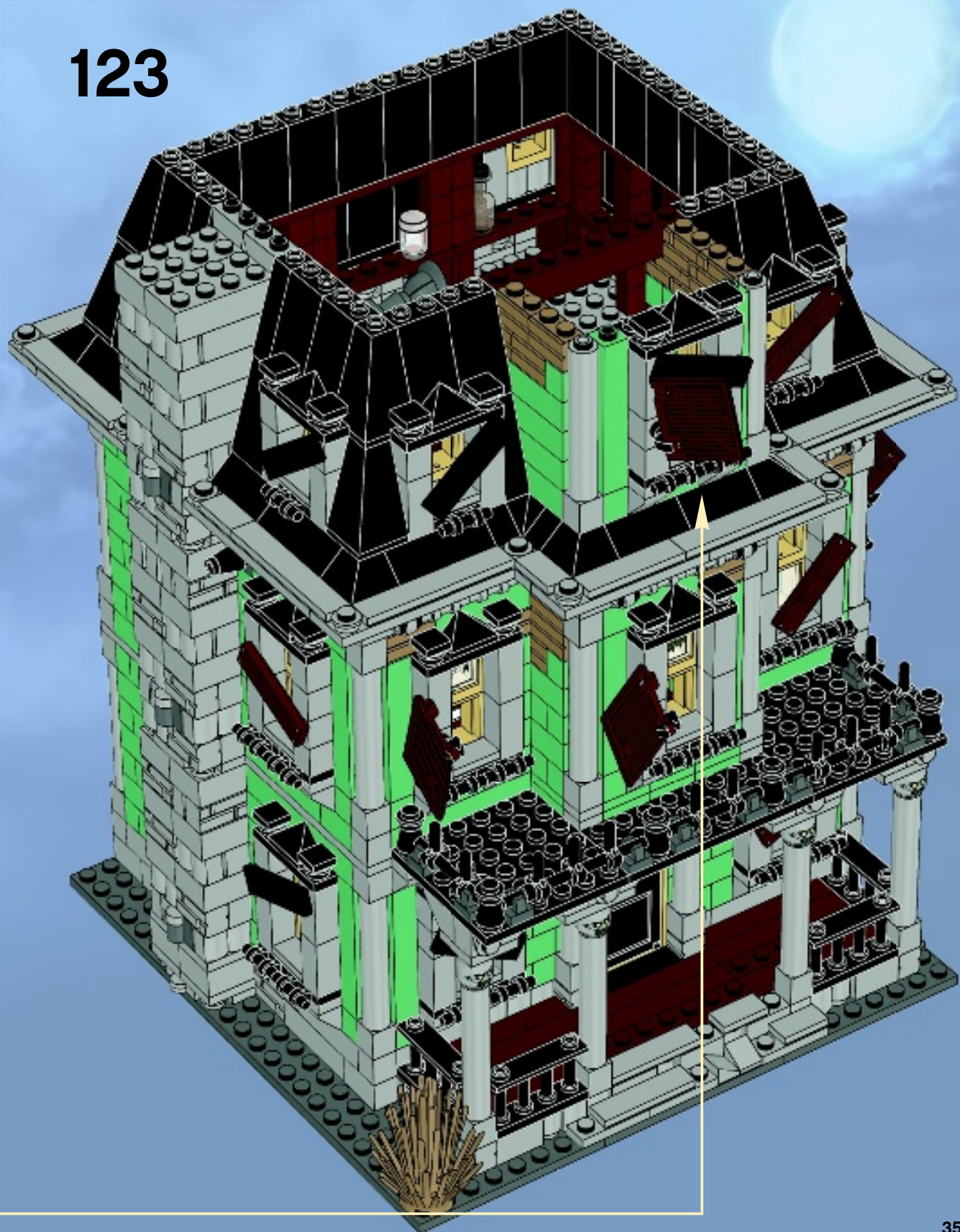



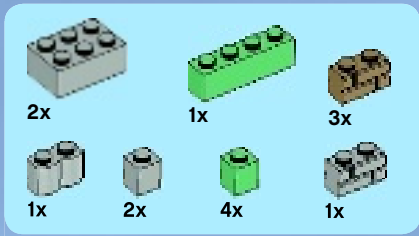

# 124

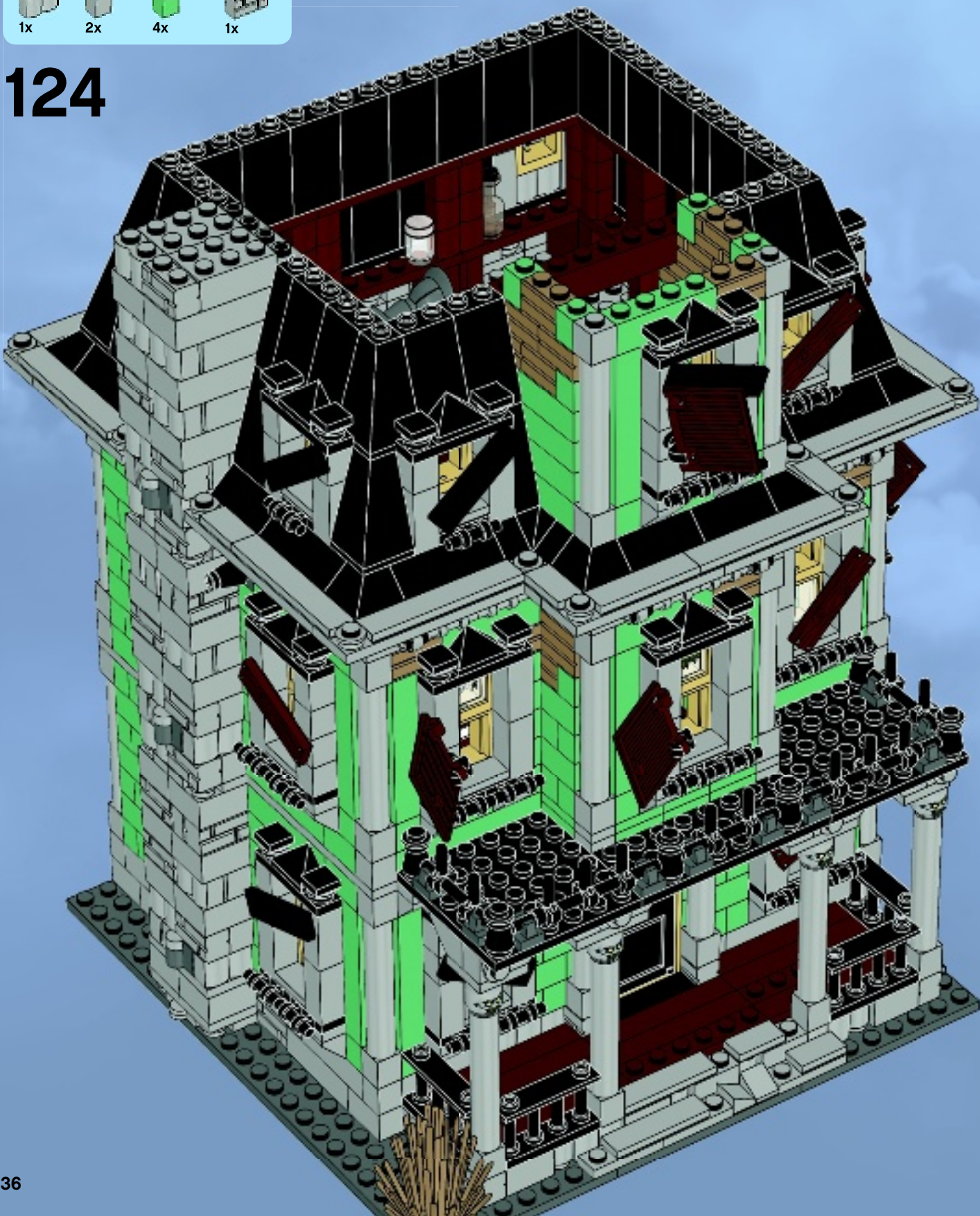

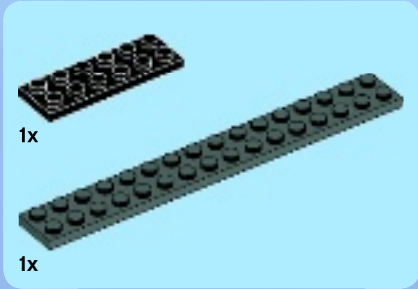

1

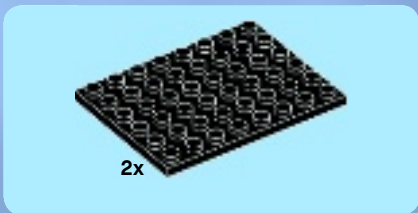
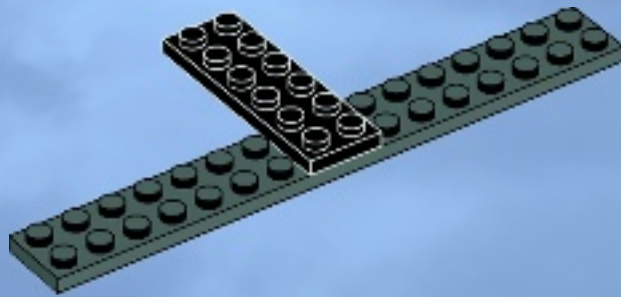

2

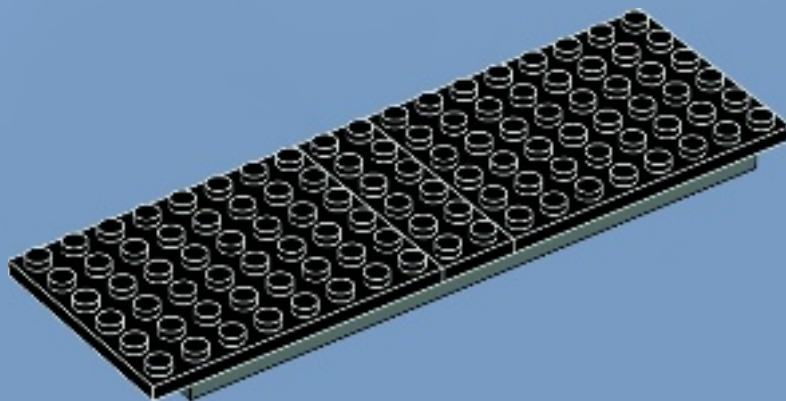



125

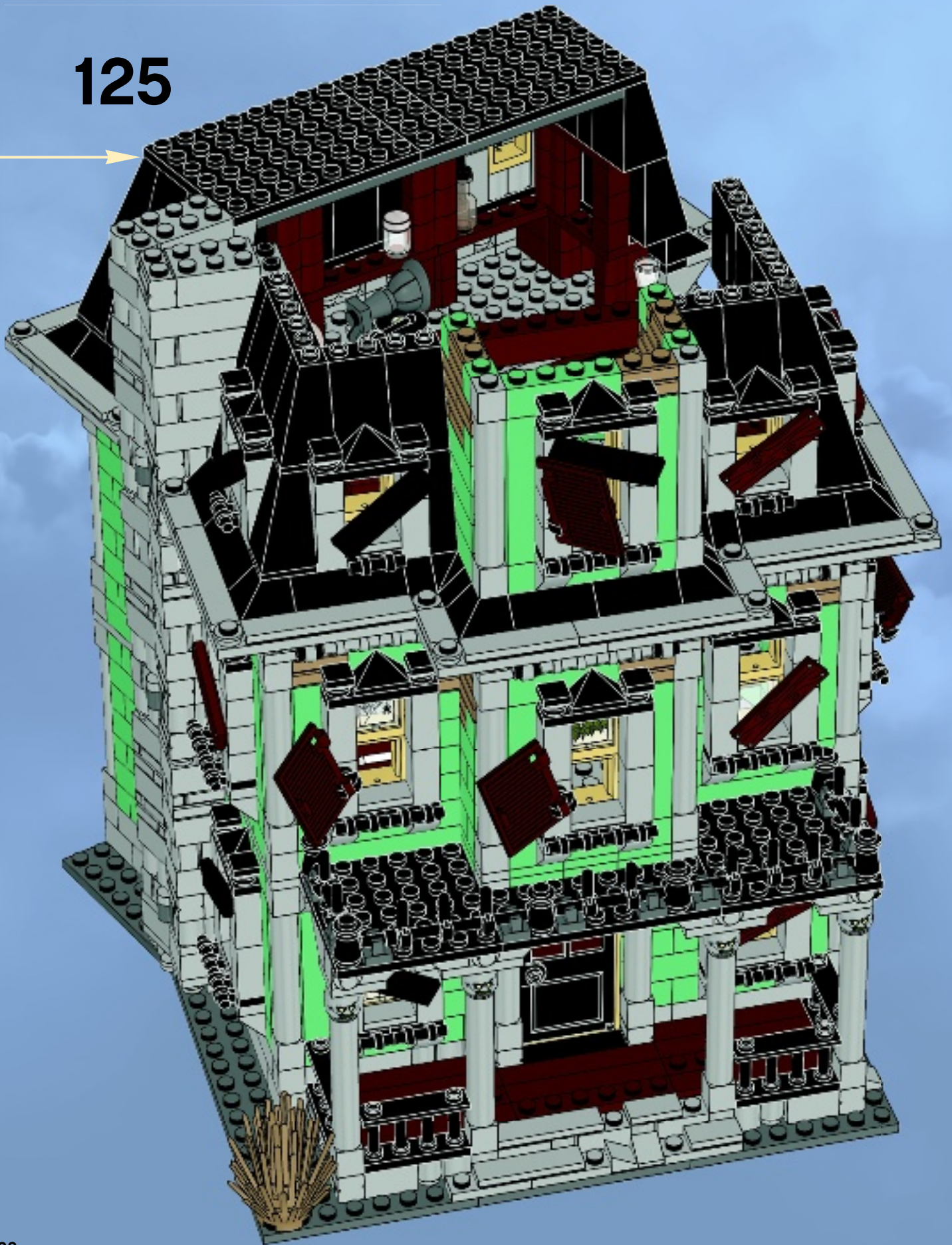

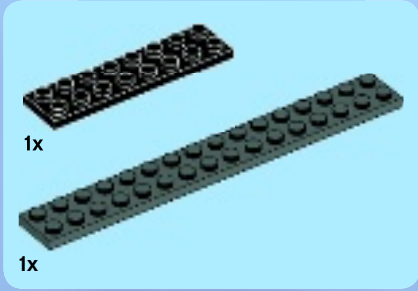

1

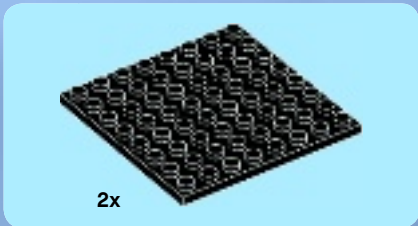
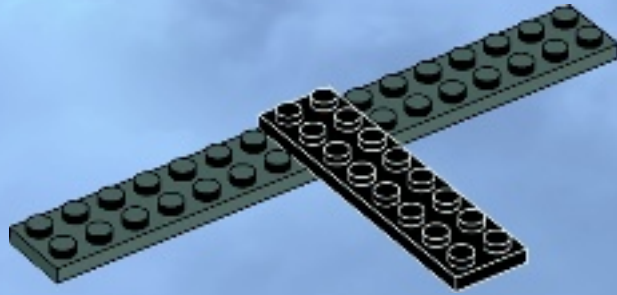

2

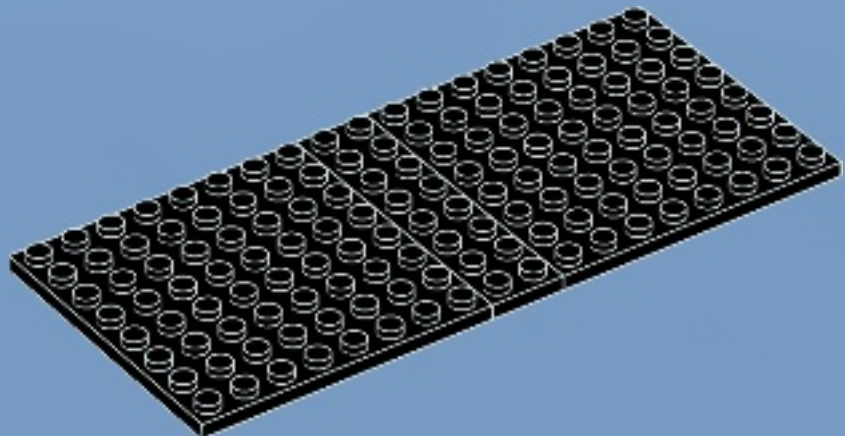



126

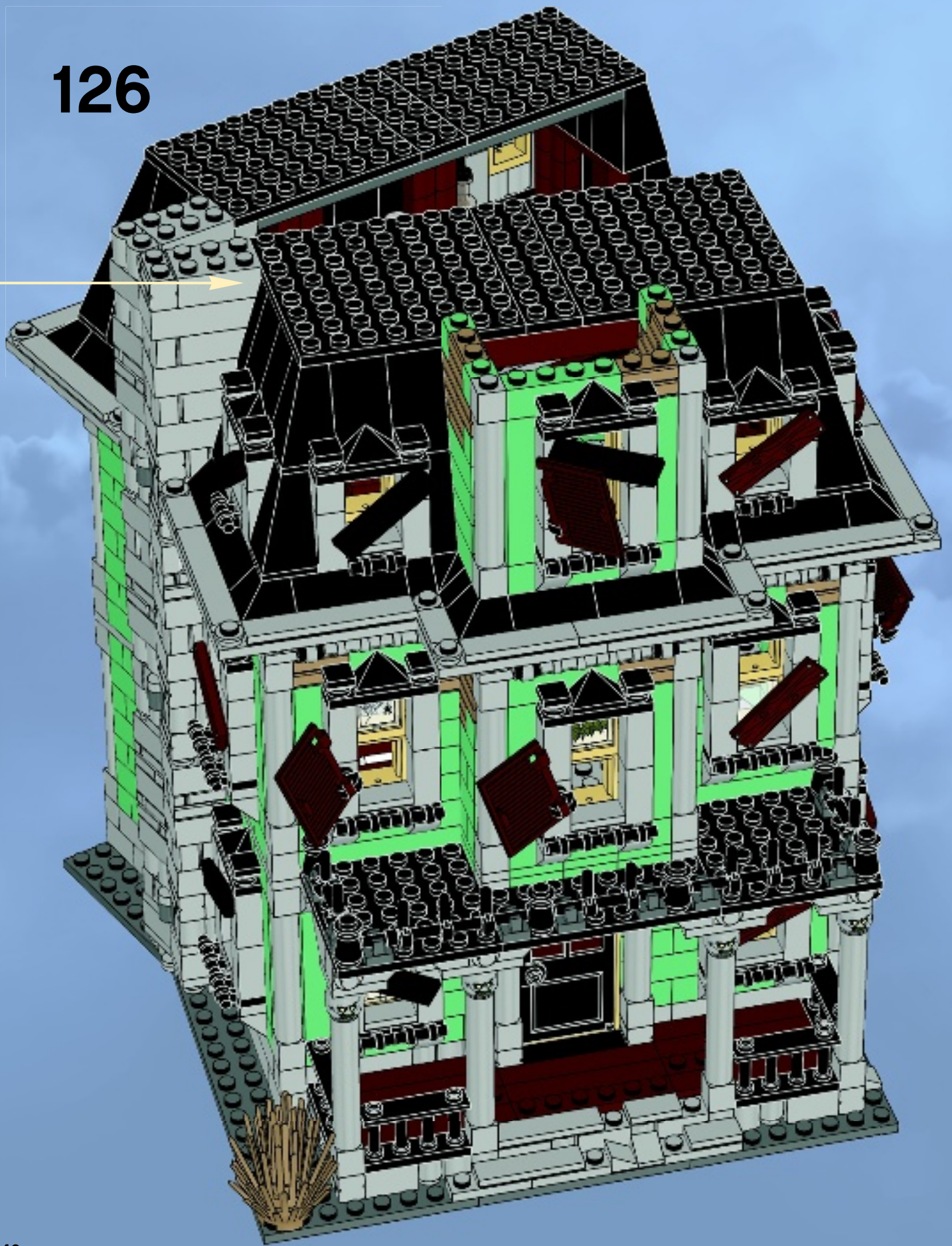





18x



6x

# 127

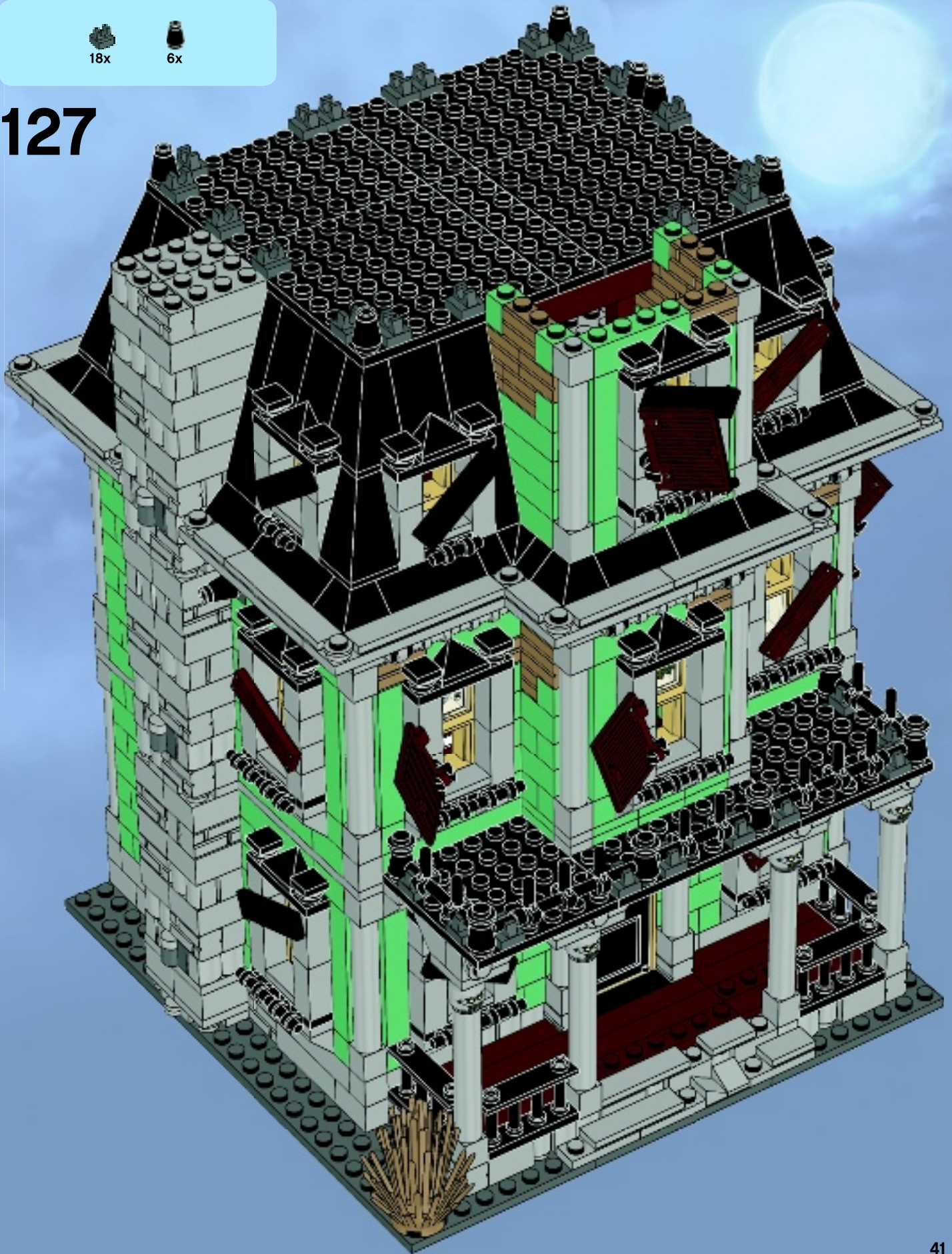



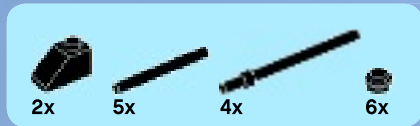

128

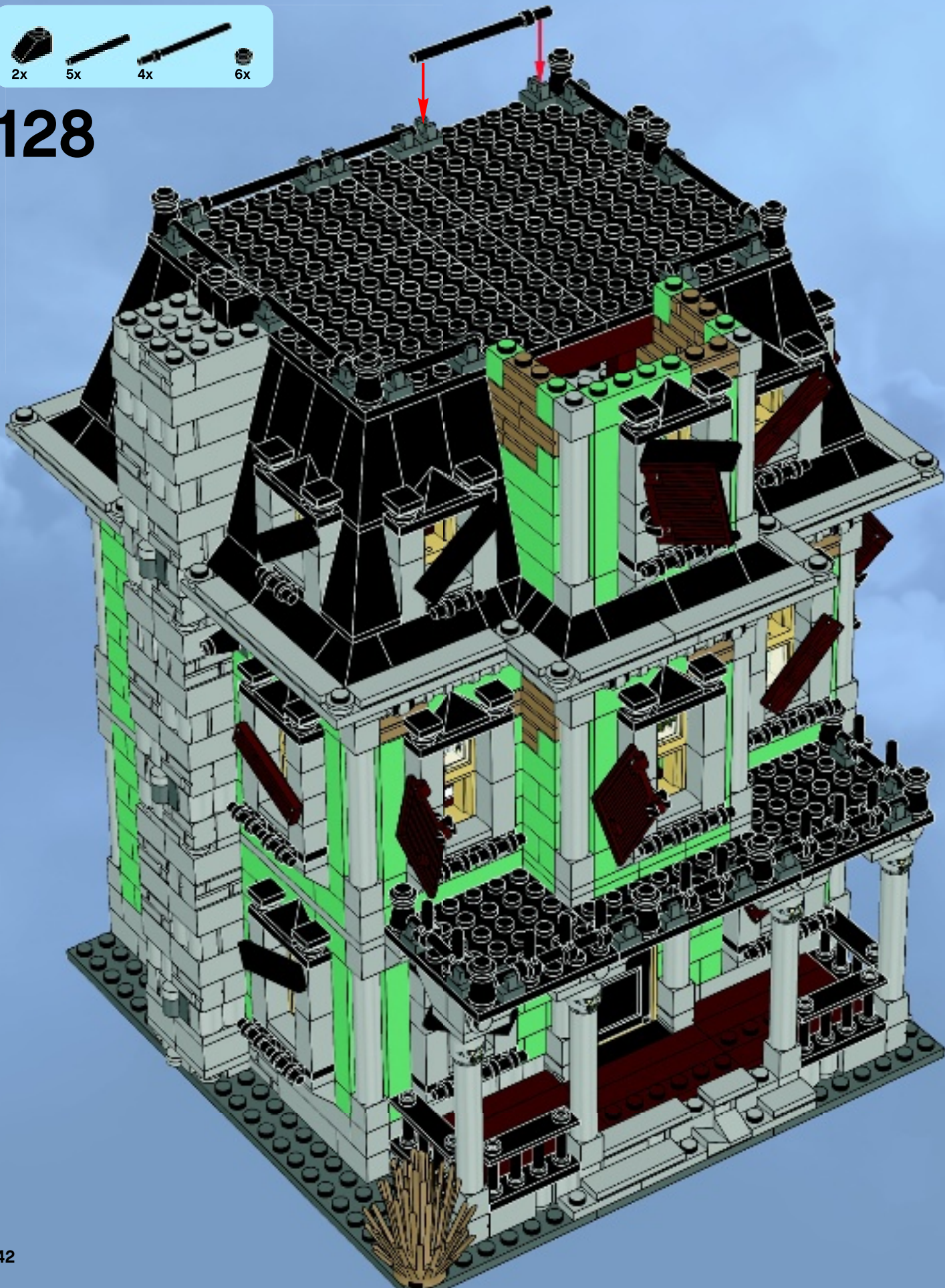





2x



2x



2x



5x

# 129

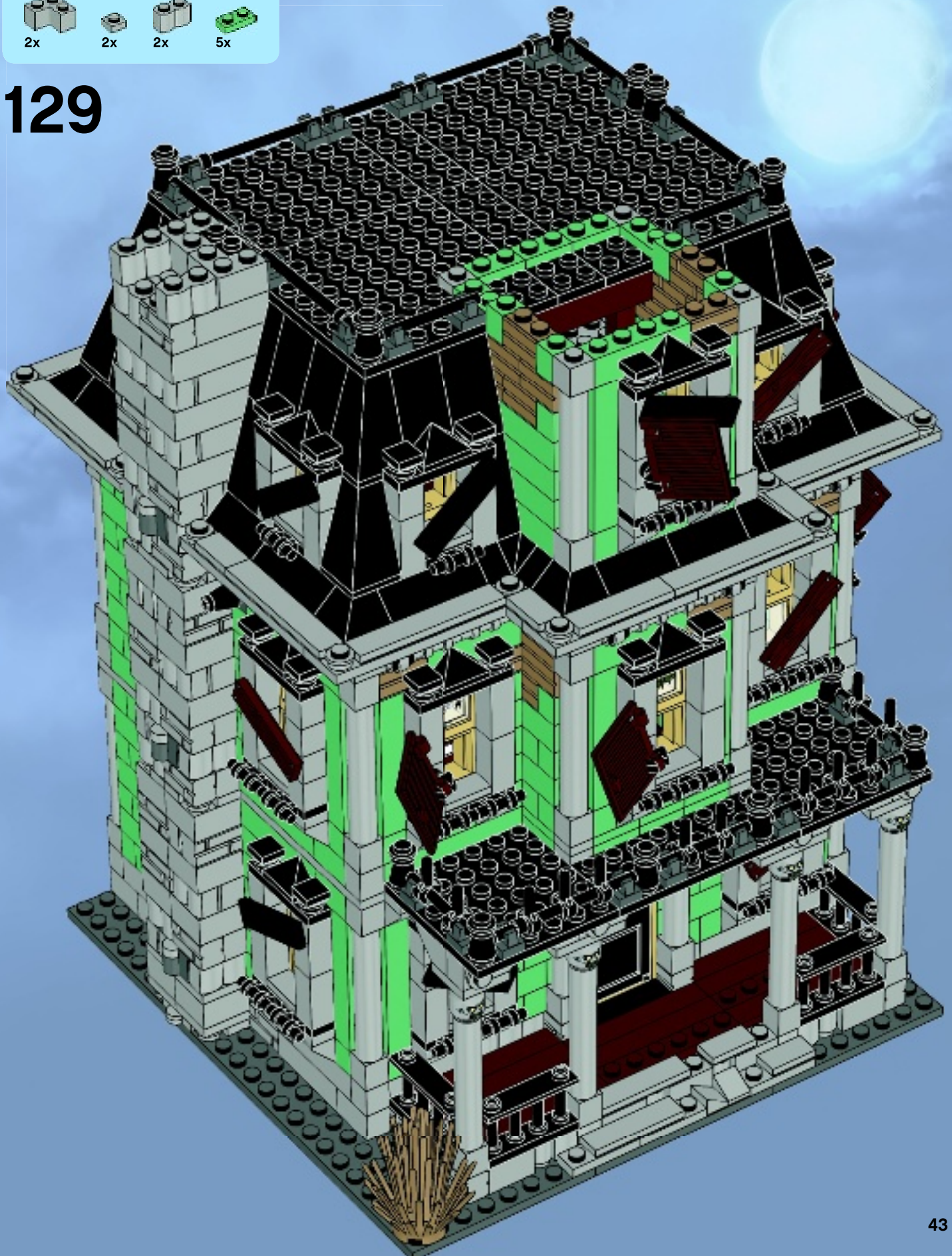





1x



22x



1x

# 130

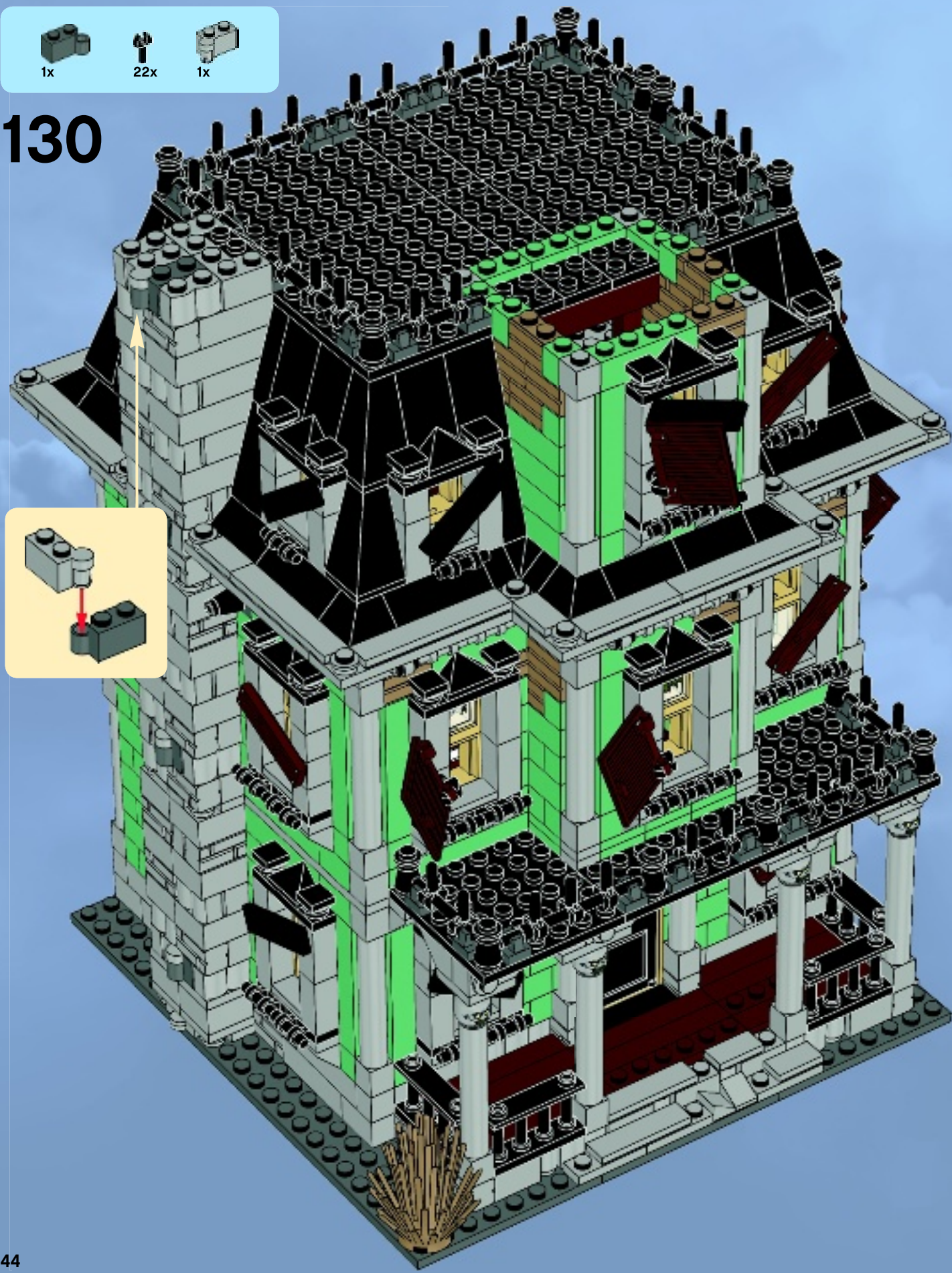



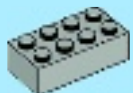

2x



2x



5x

# 131

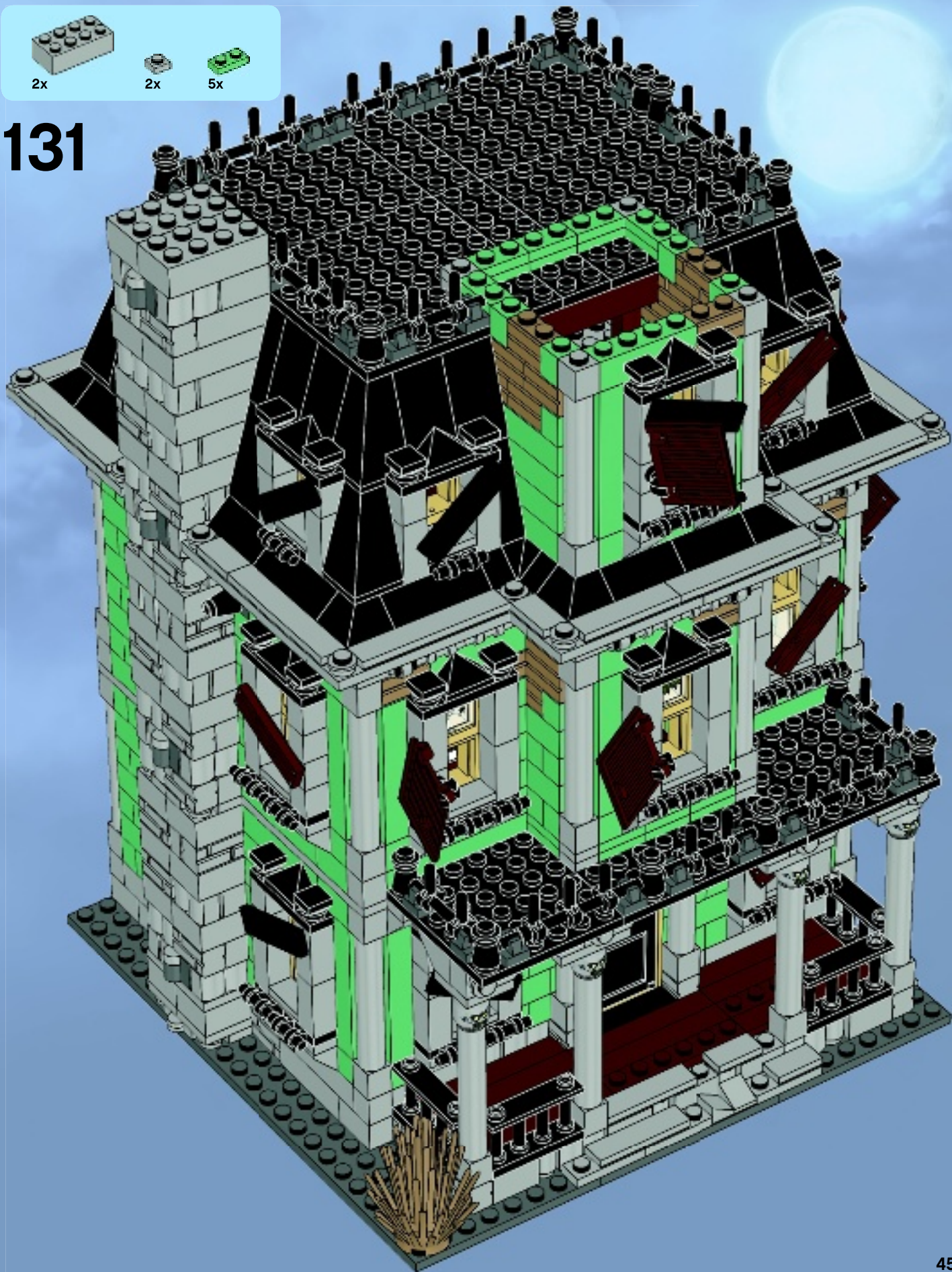





132

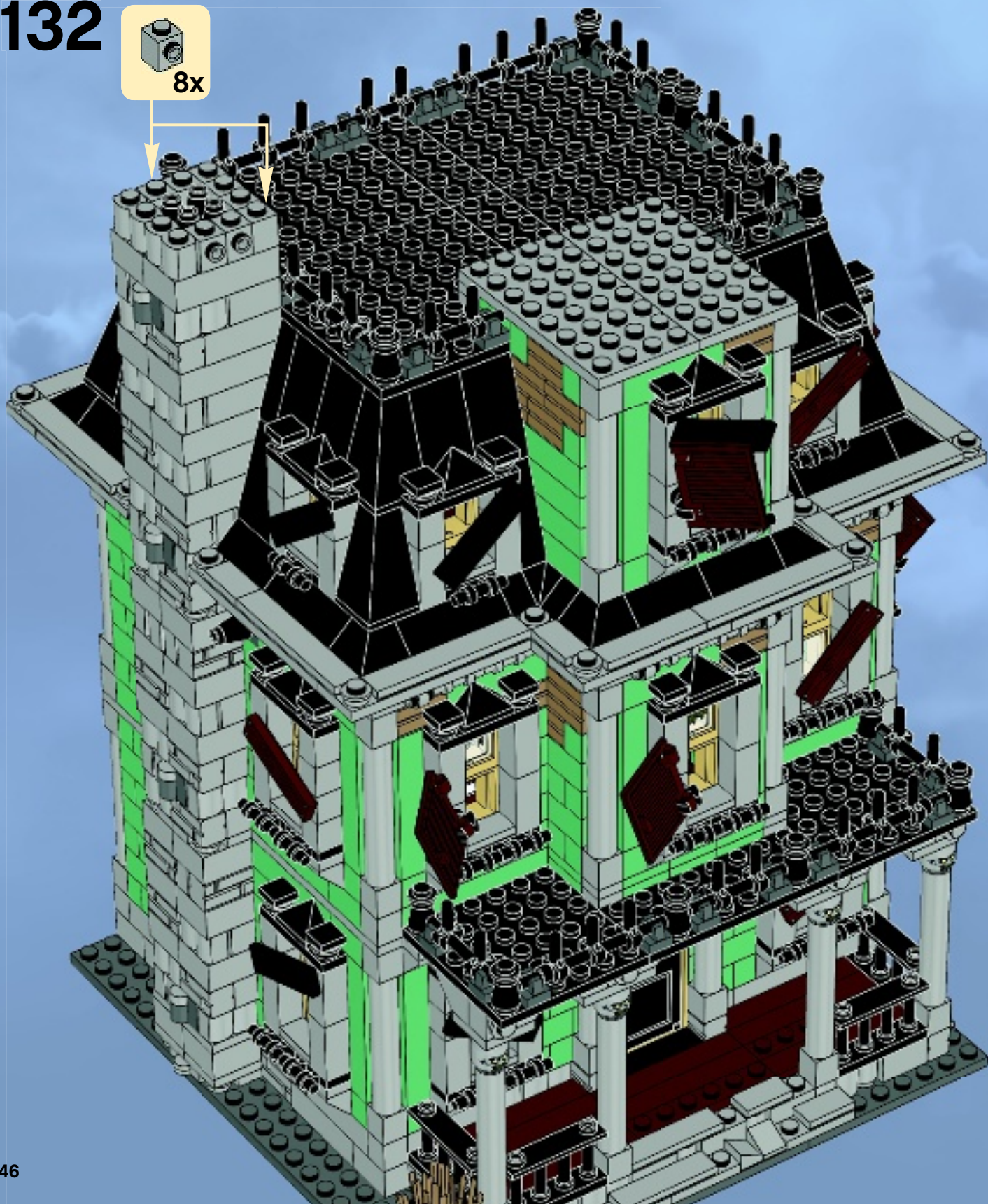





4x



2x



2x

# 133



2x

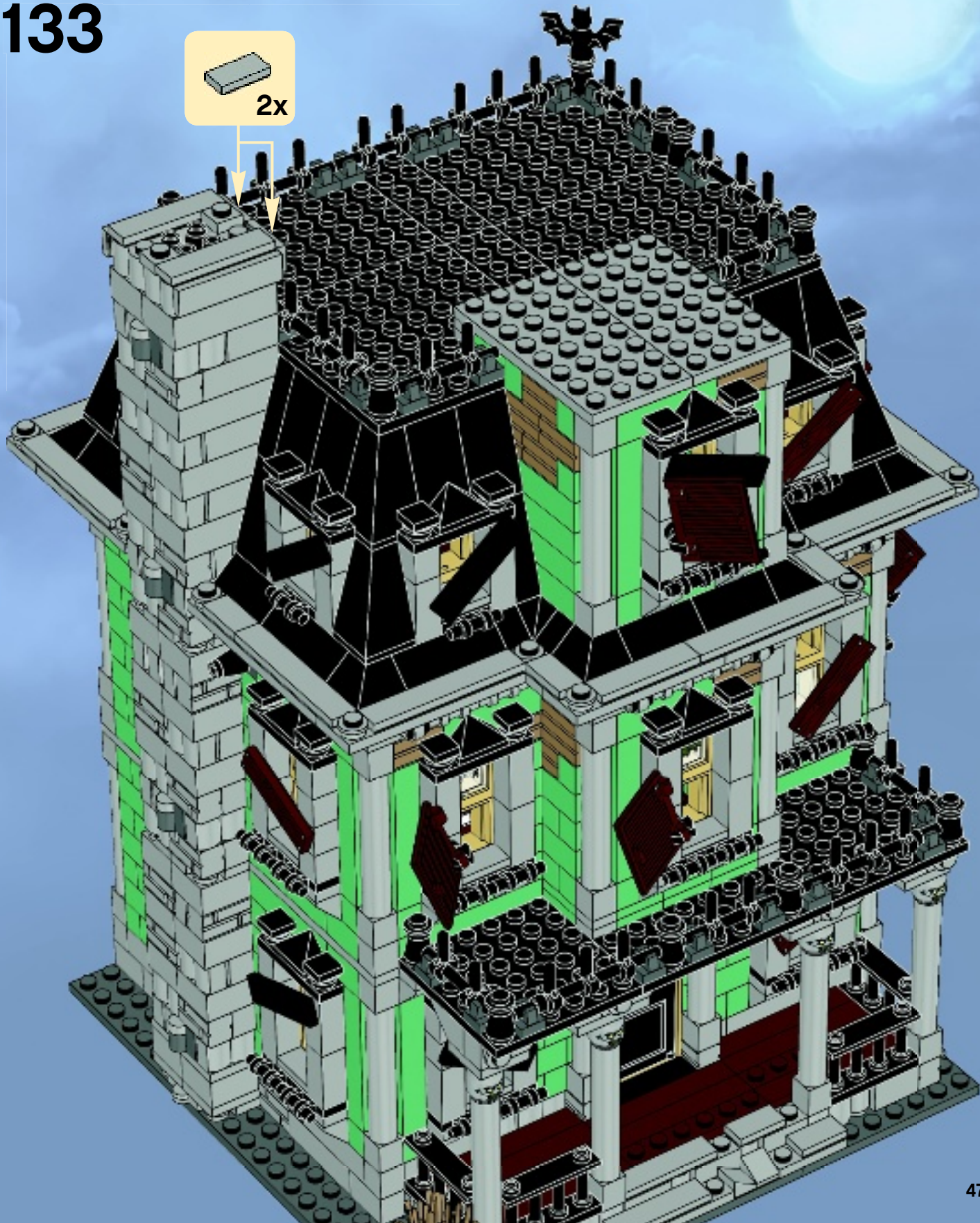





5

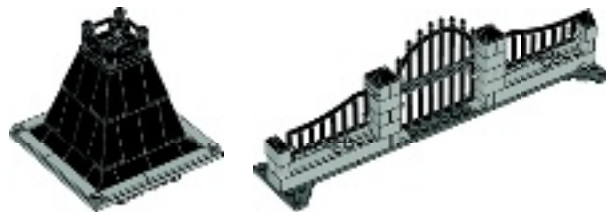

4x



8x



8x

134

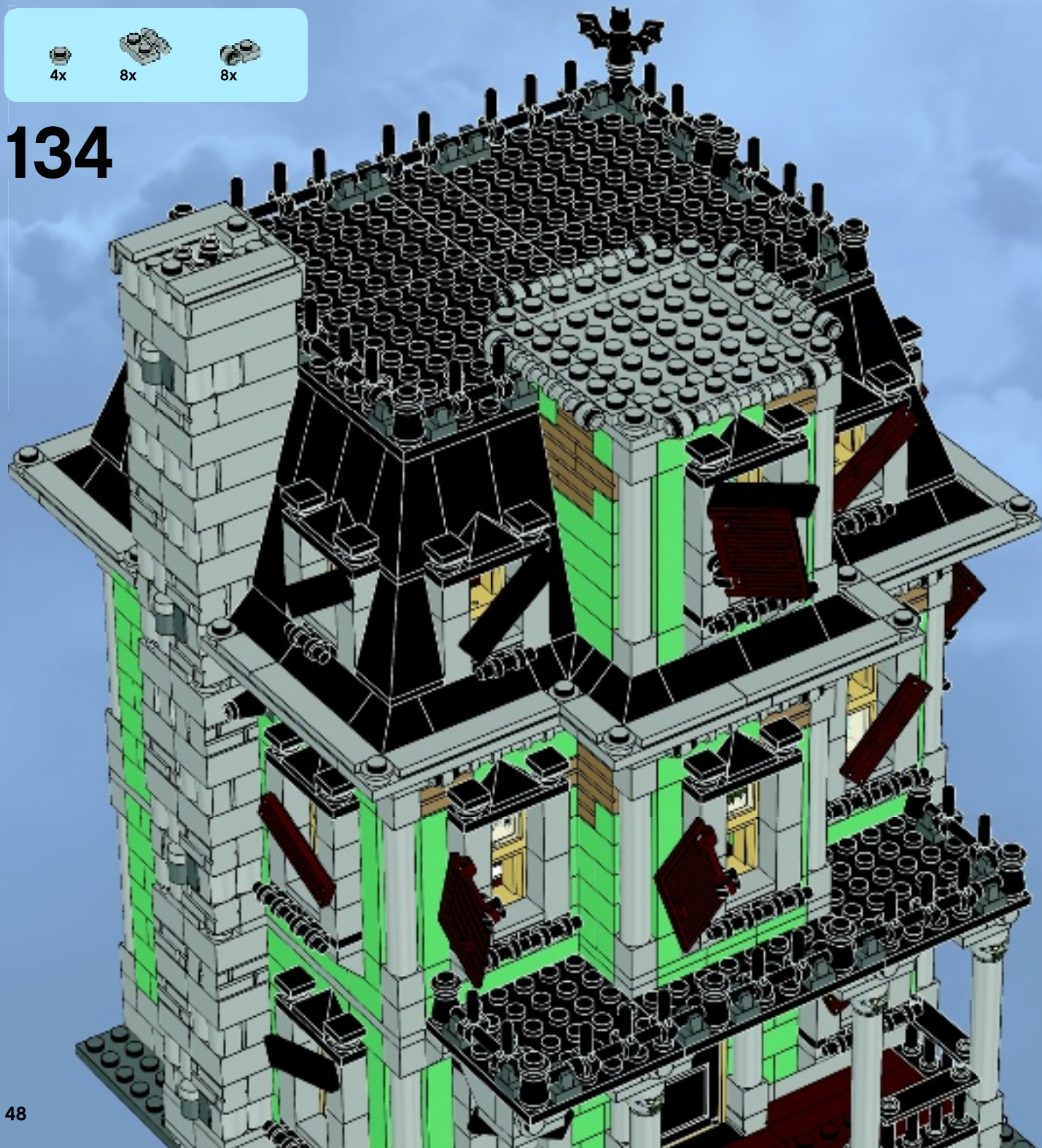





4x



8x



8x

# 135

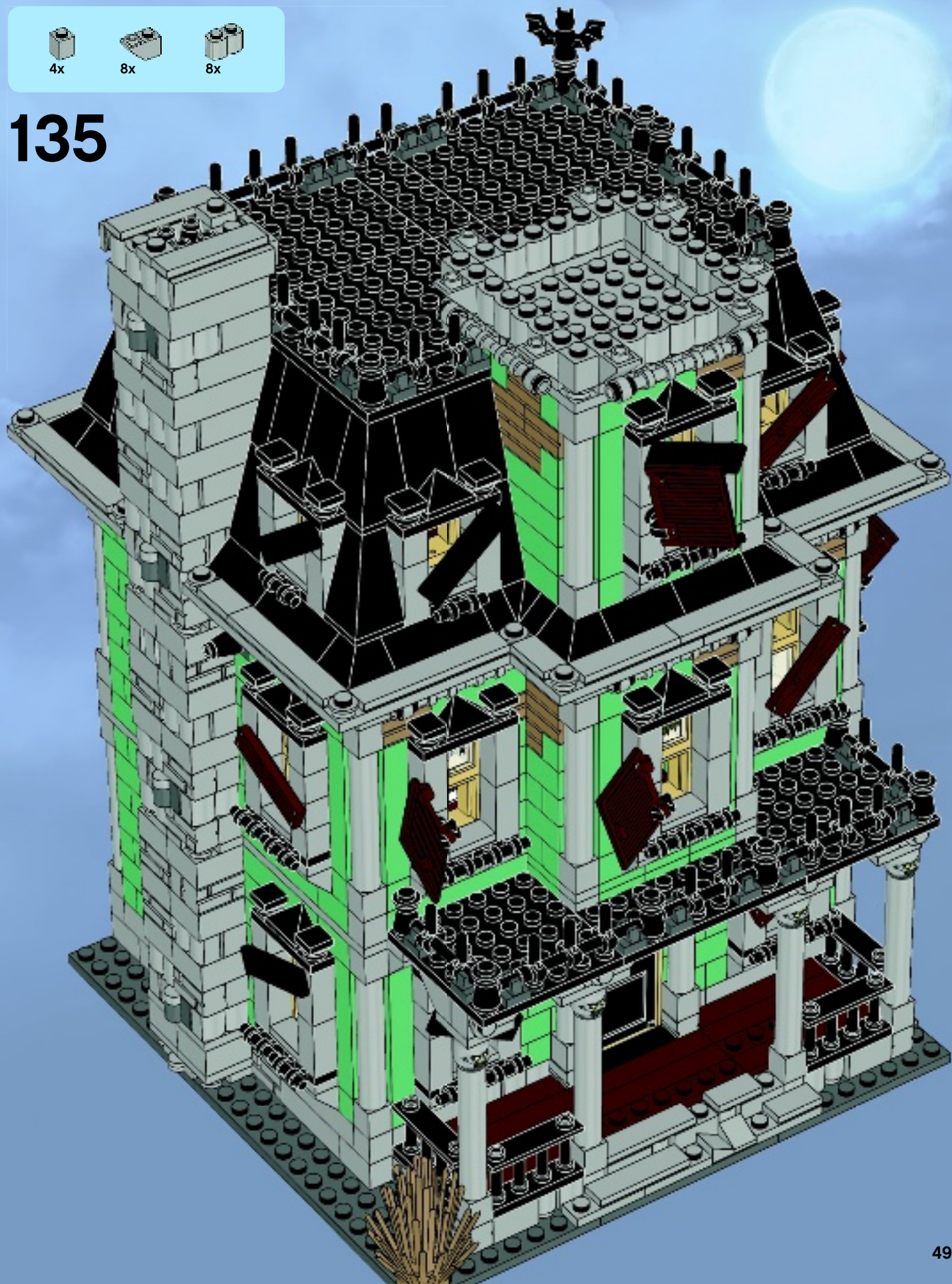



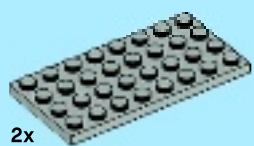

2x

# 136

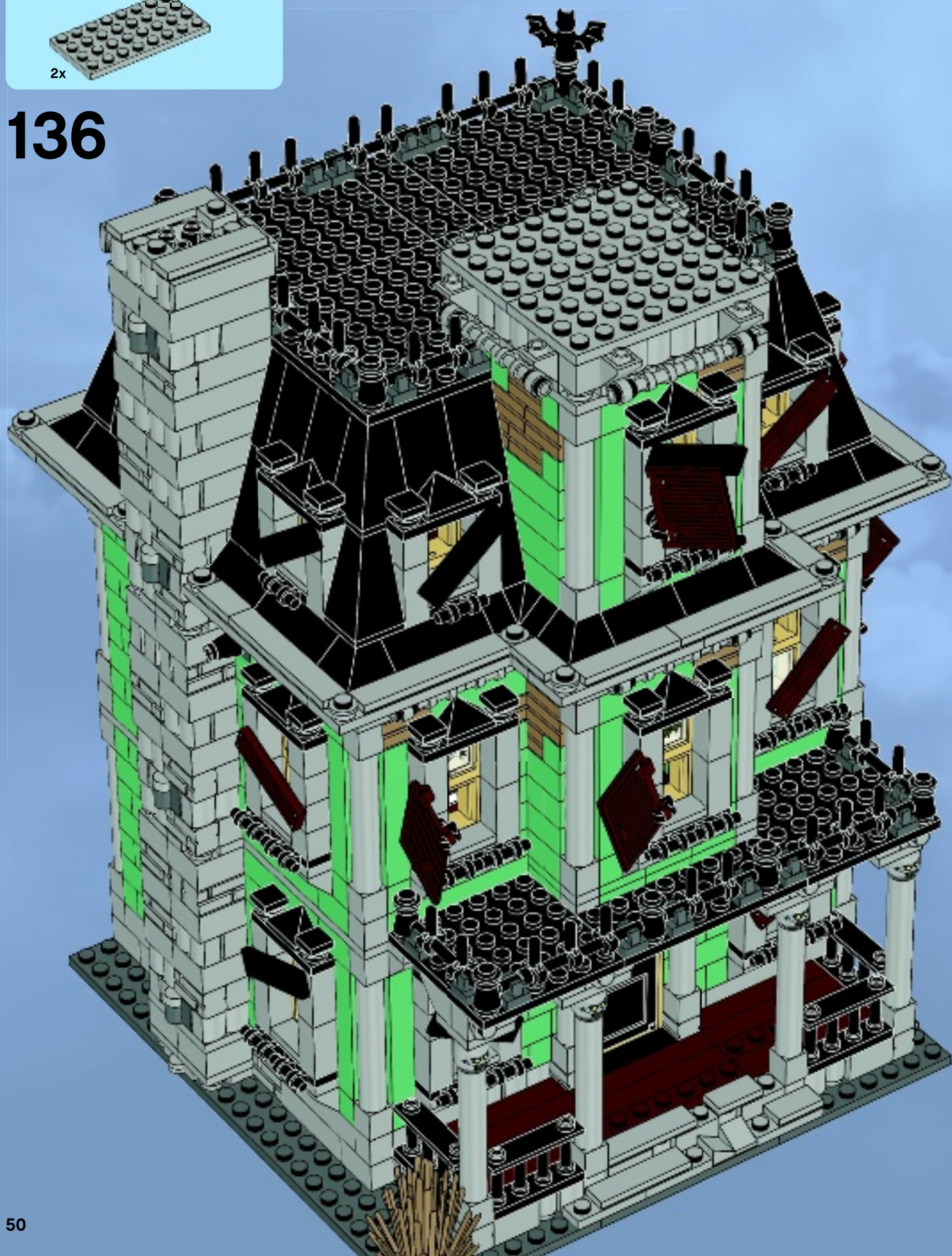



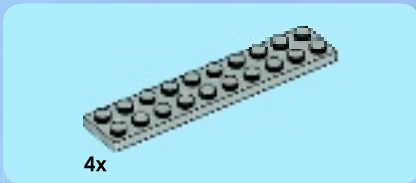

4x

# 137

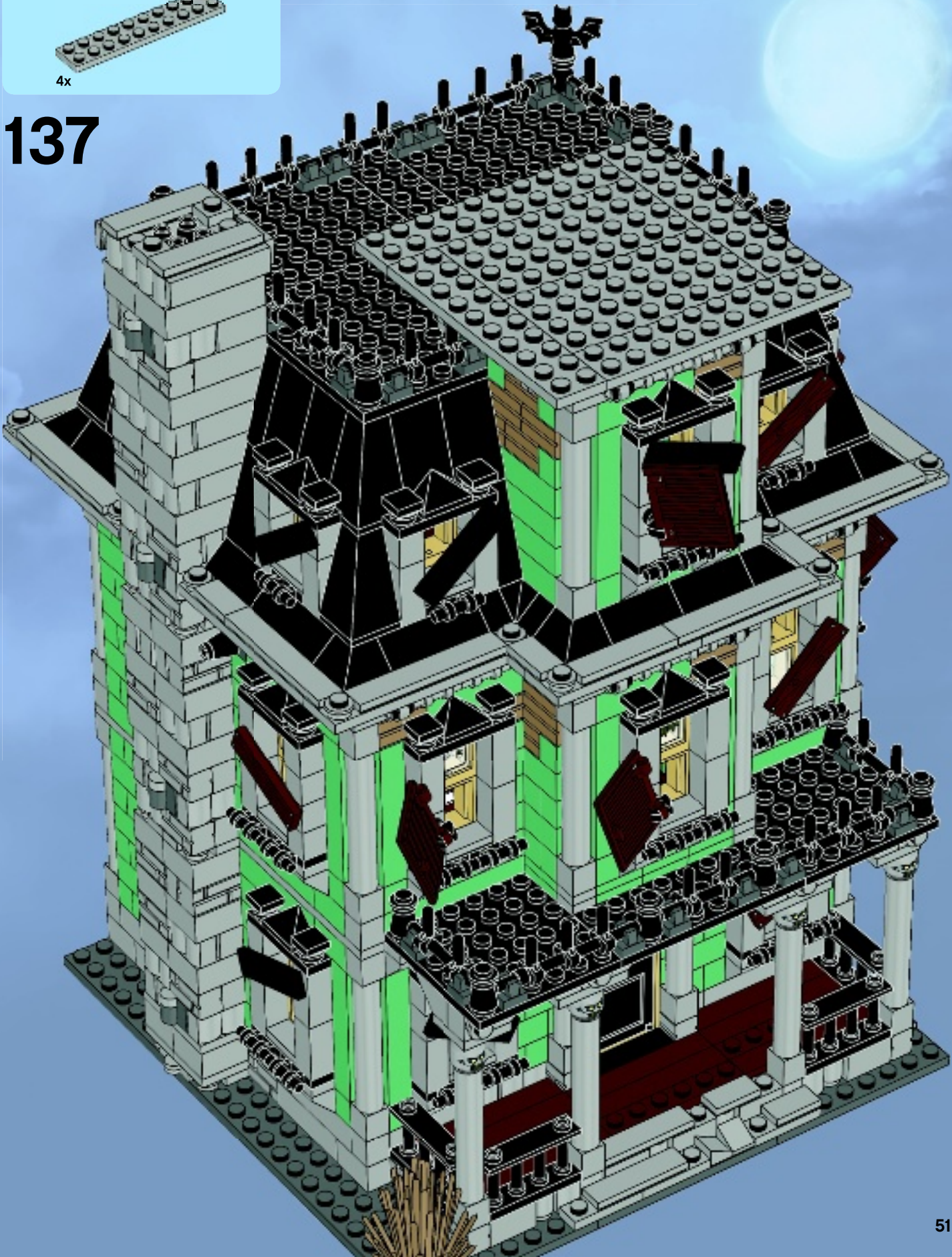



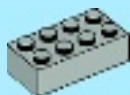

4x

# 138

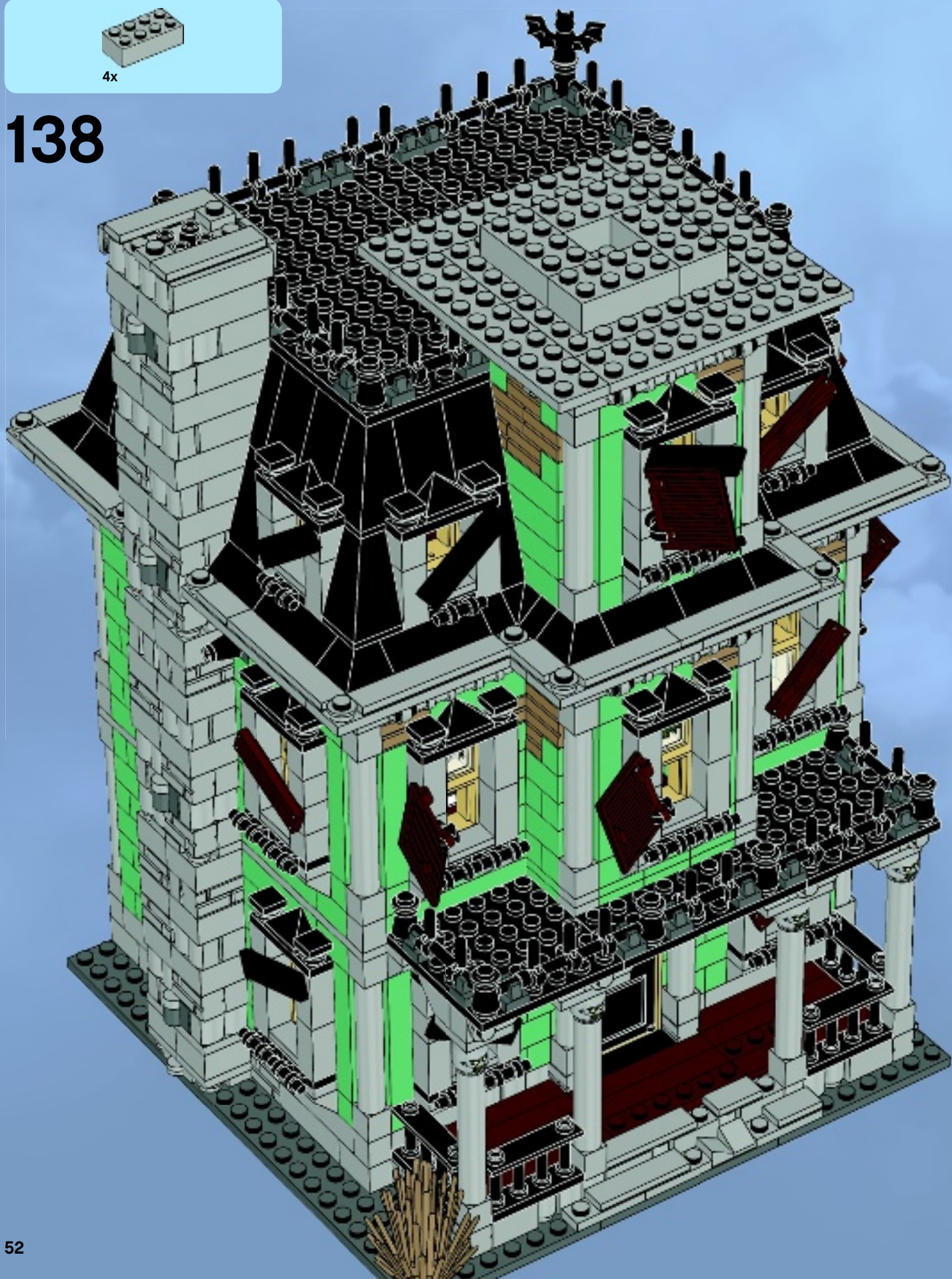





8x



4x

# 139

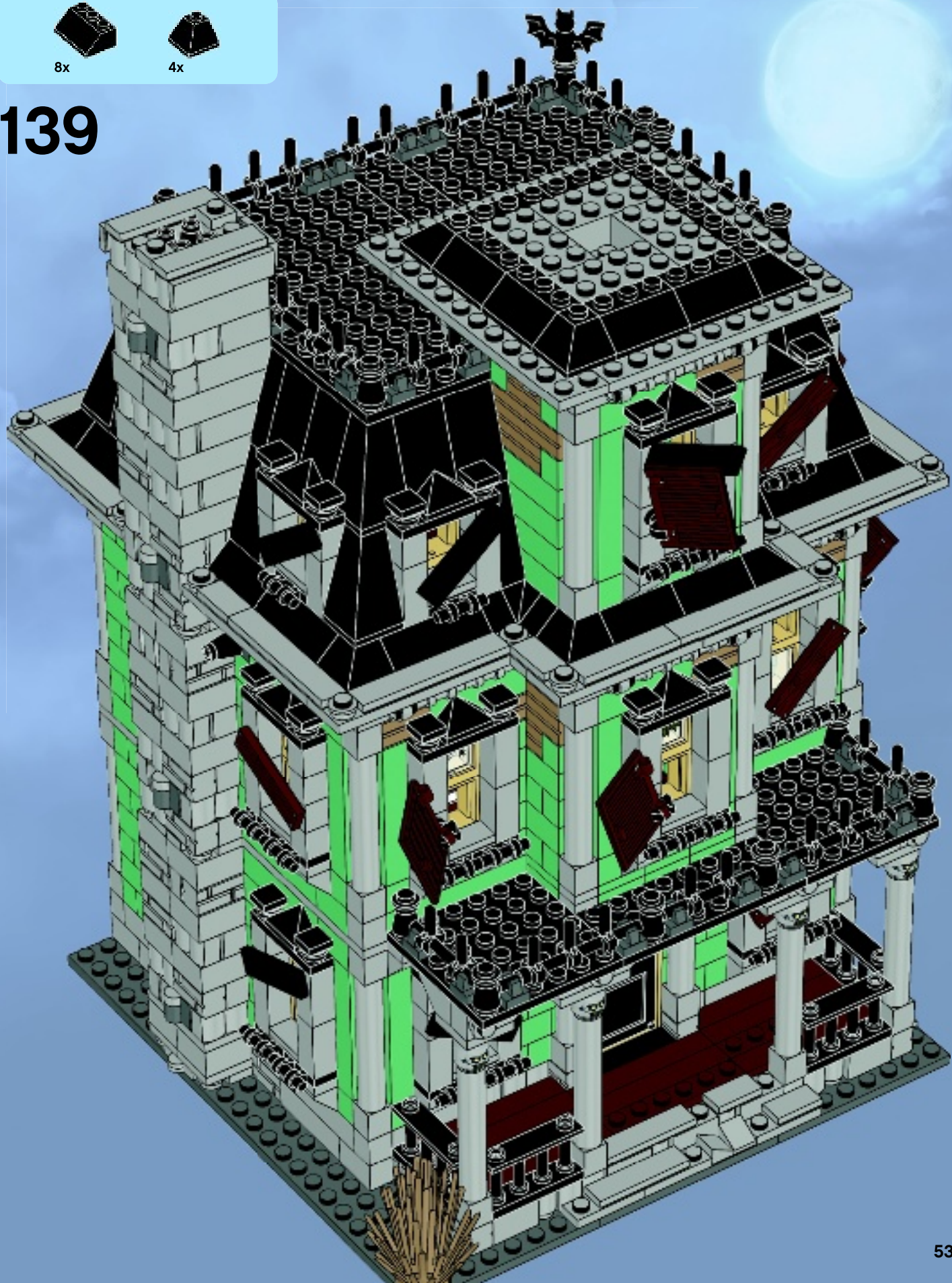



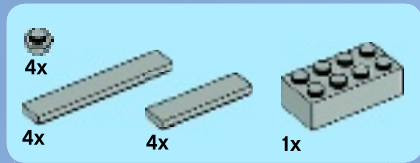

# 140

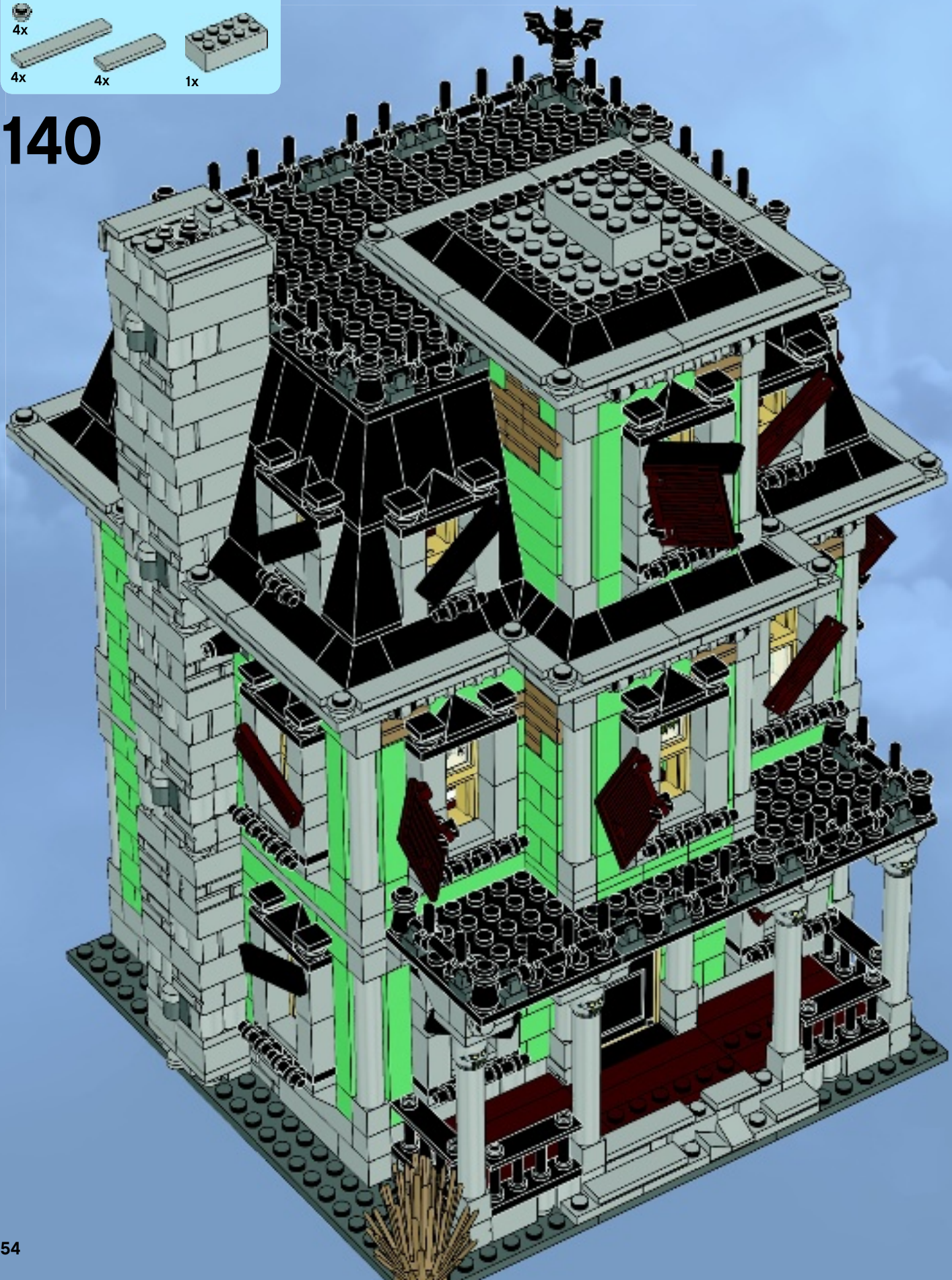



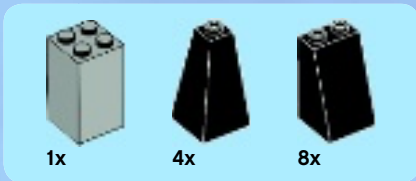

1x

4x

8x

# 141

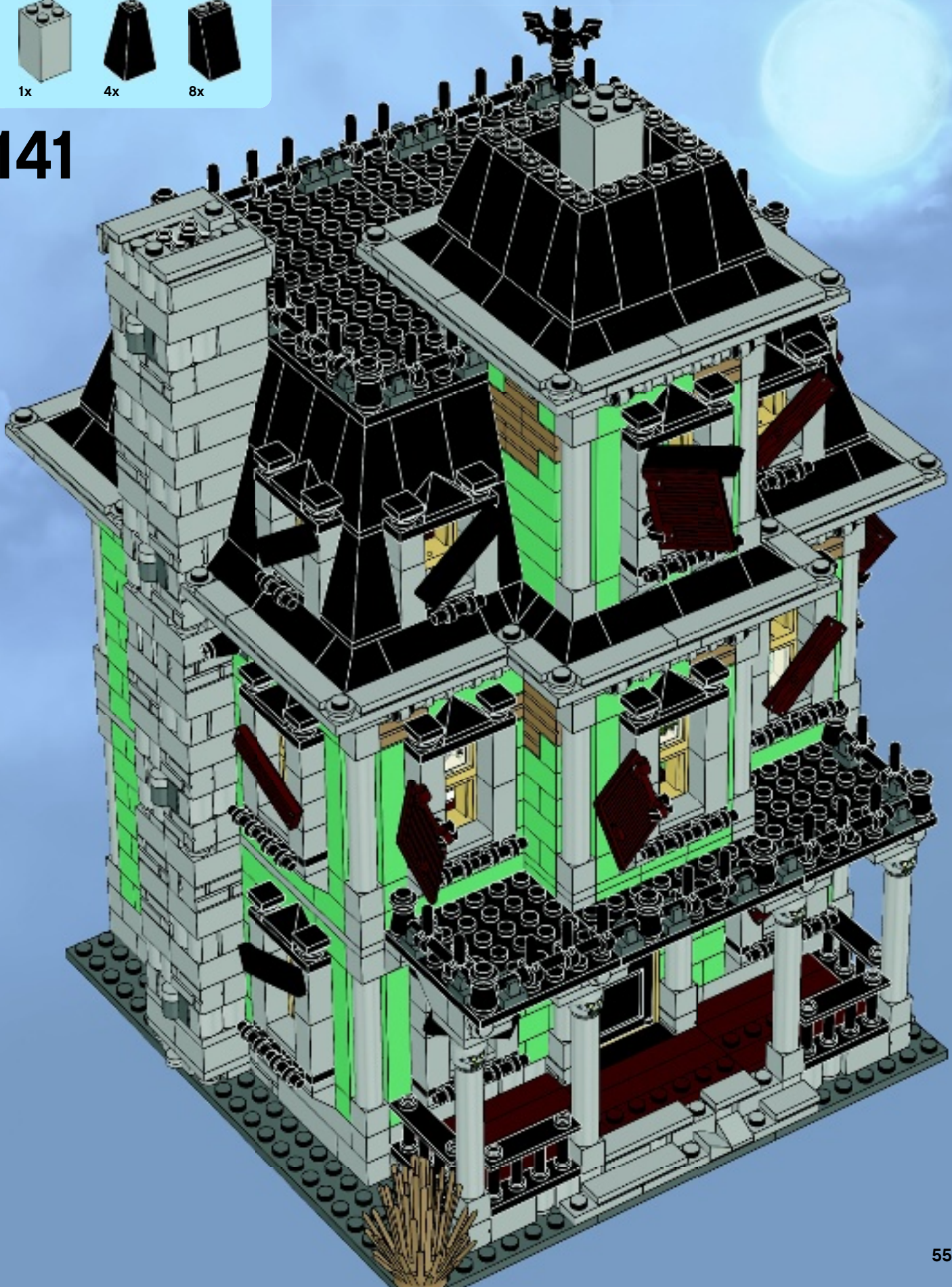



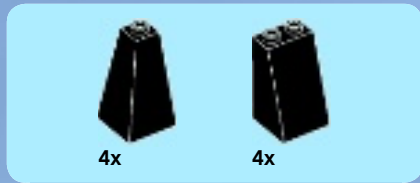

142

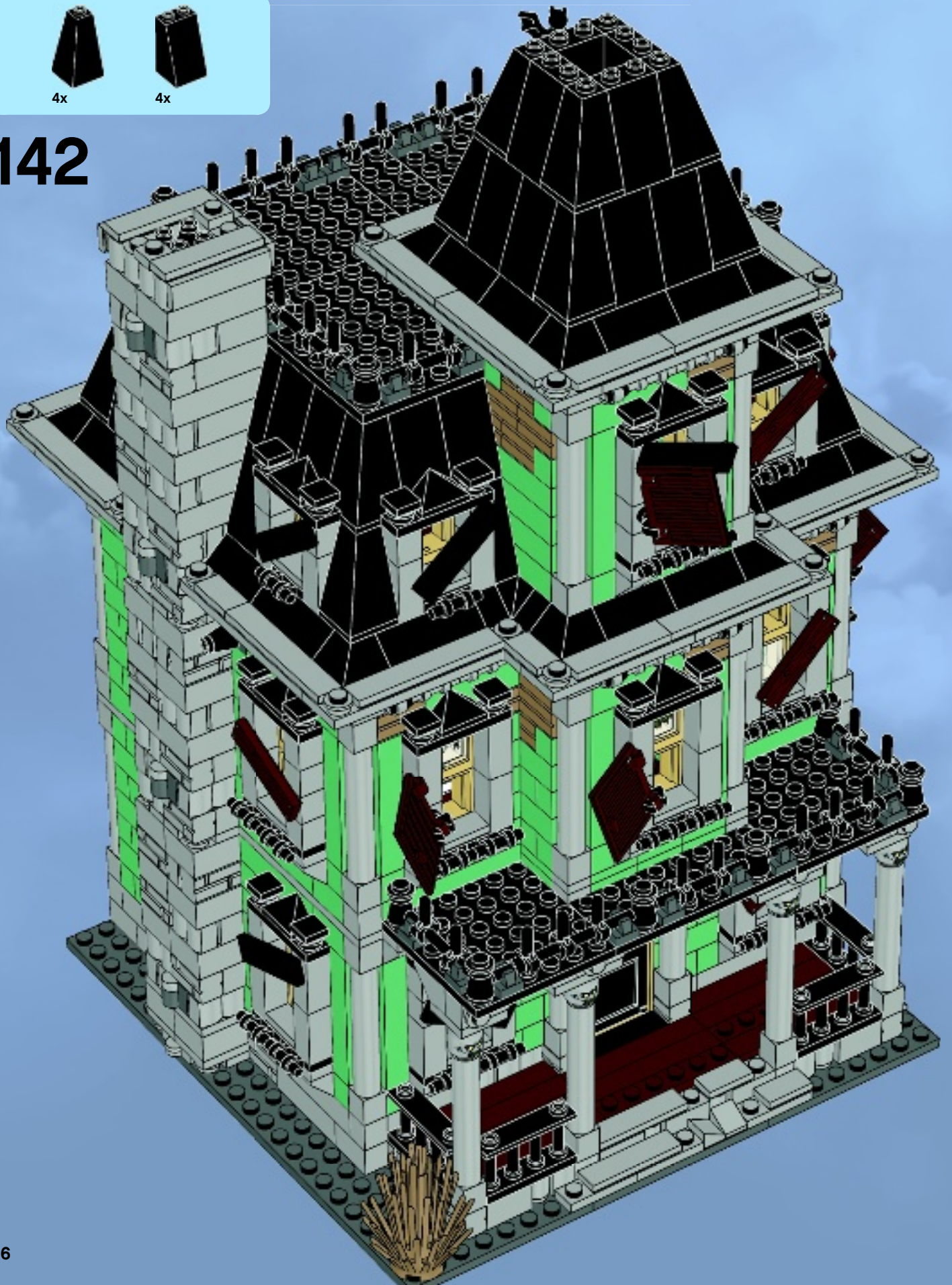





2x

# 143

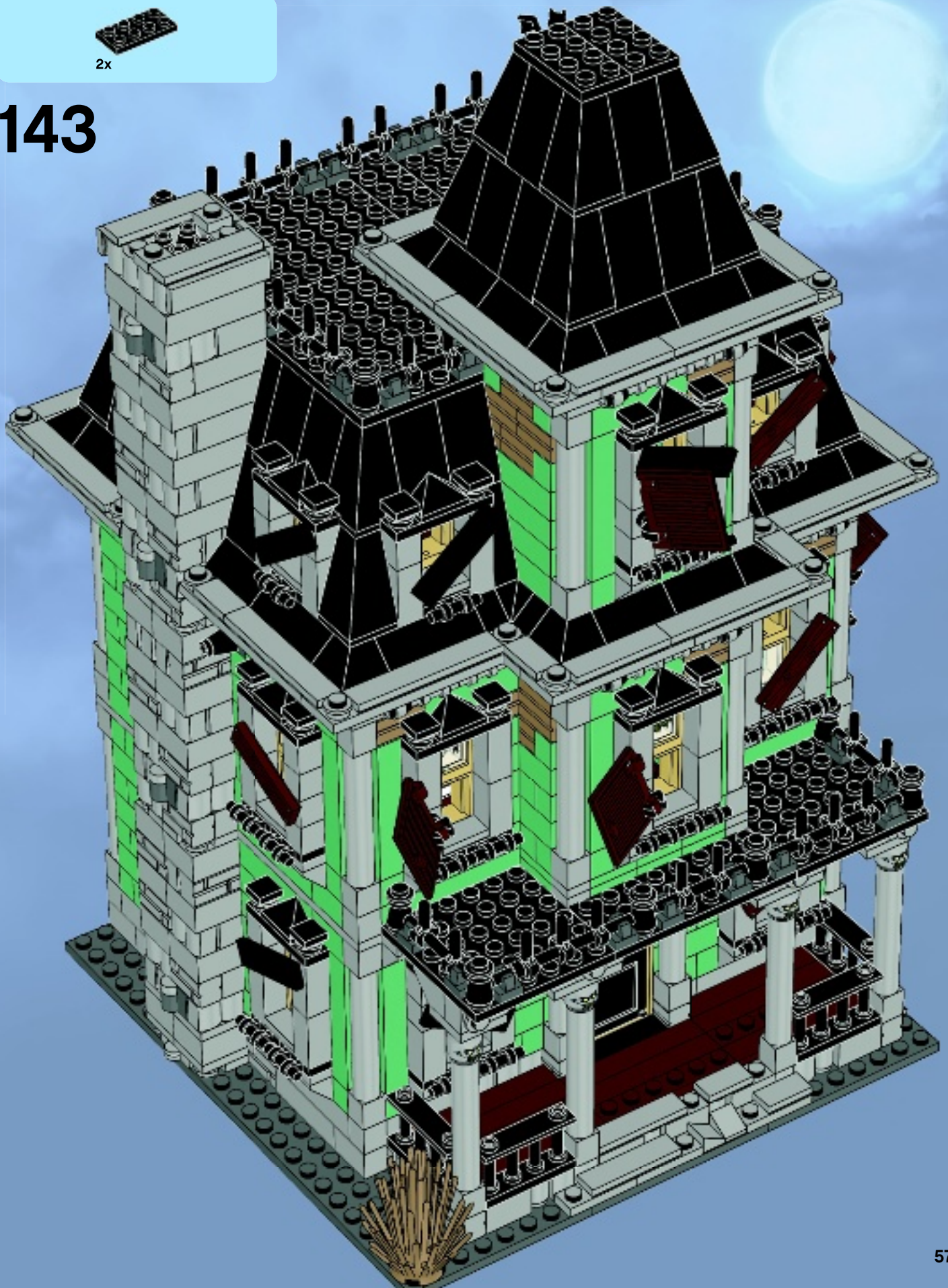





4x

144

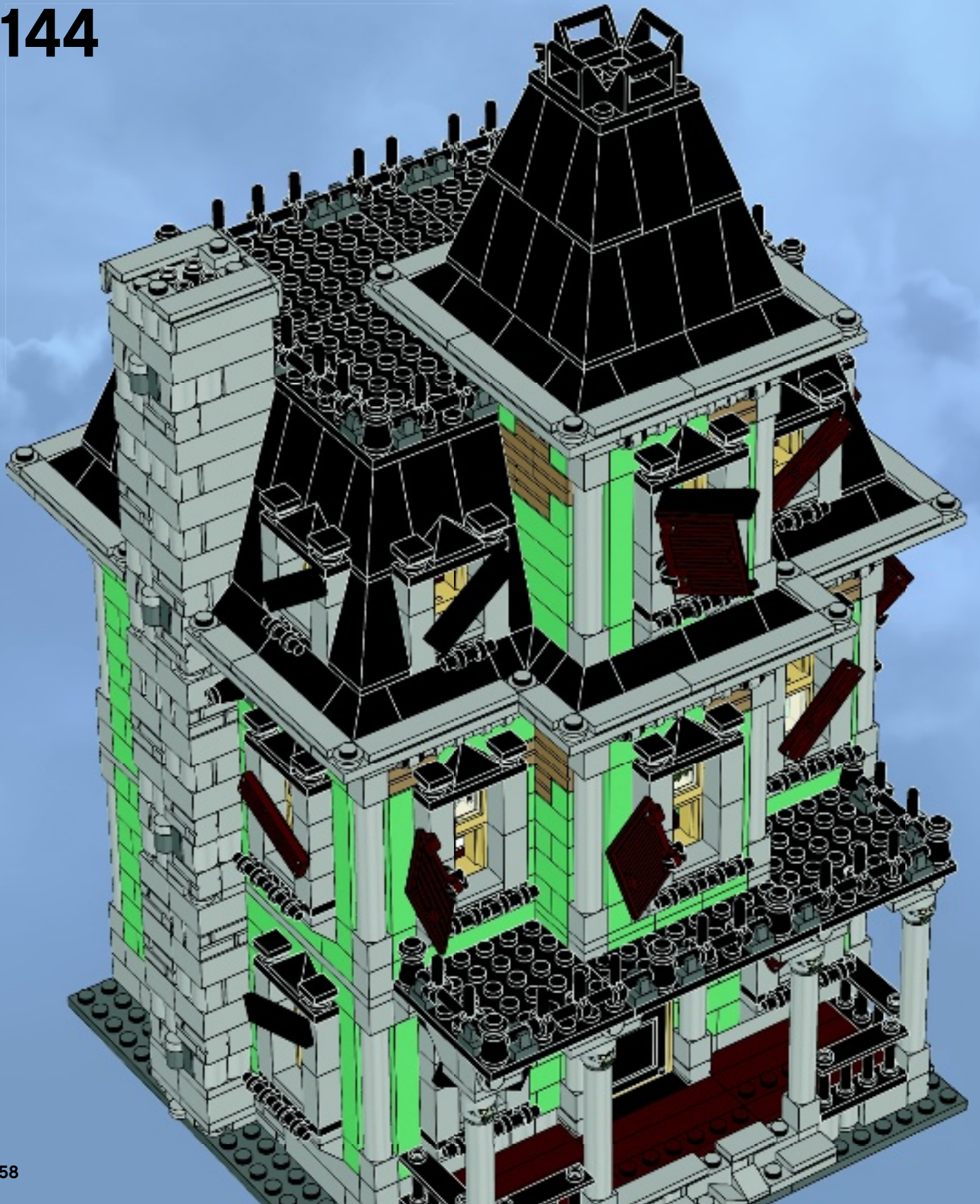



8x

4x

# 145



4x

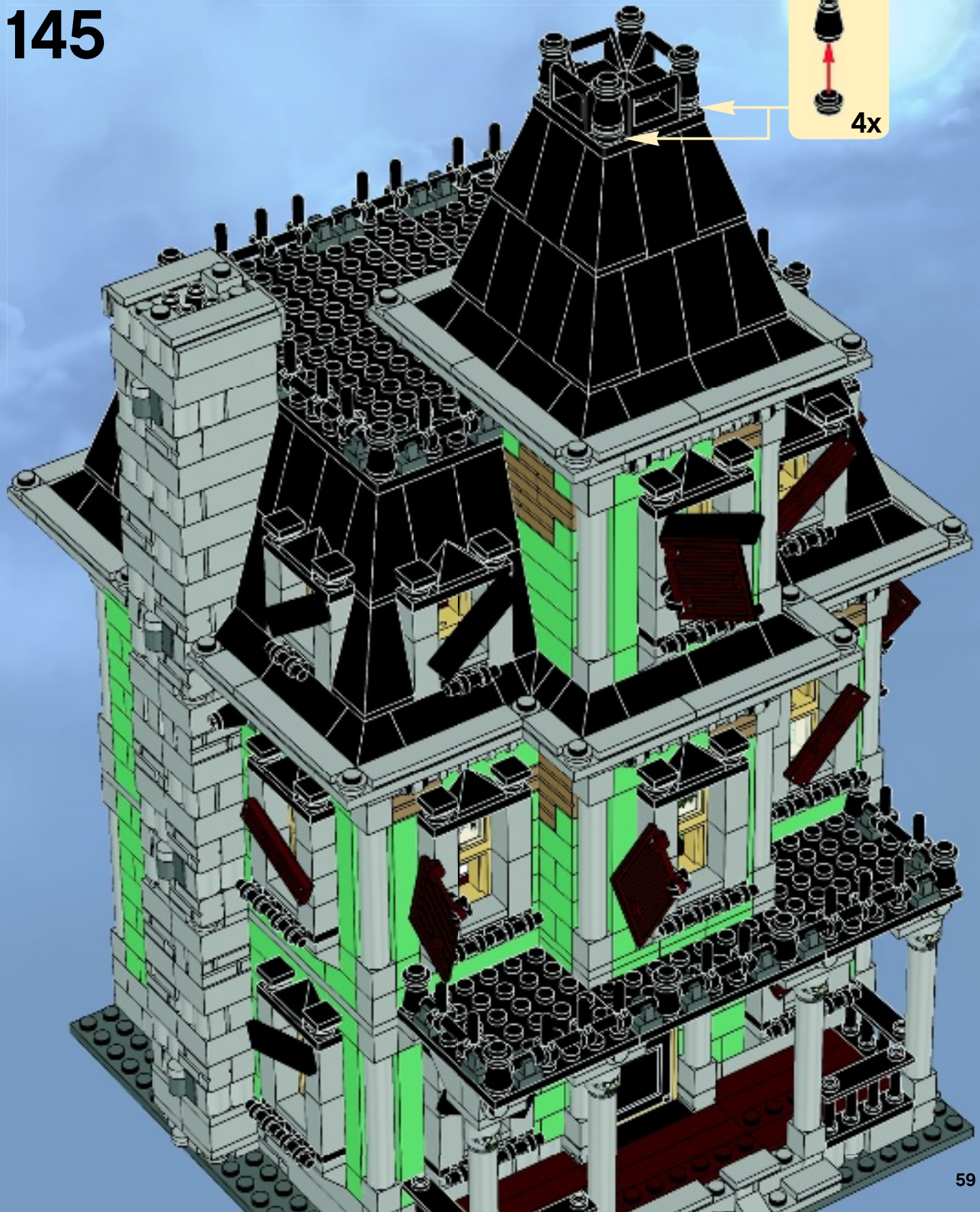



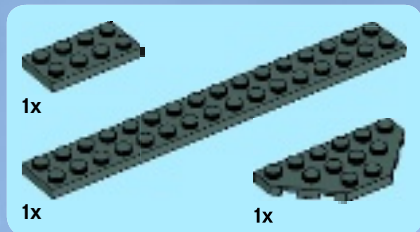
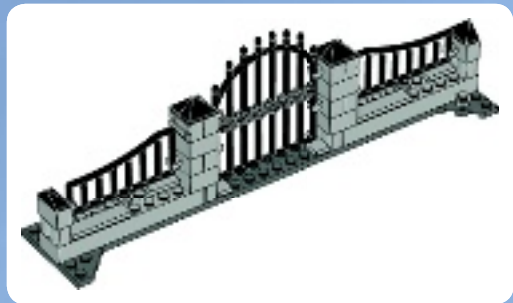

1

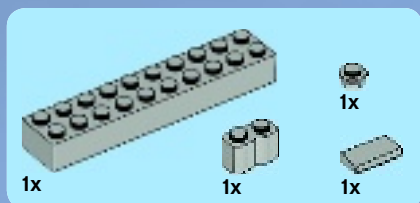
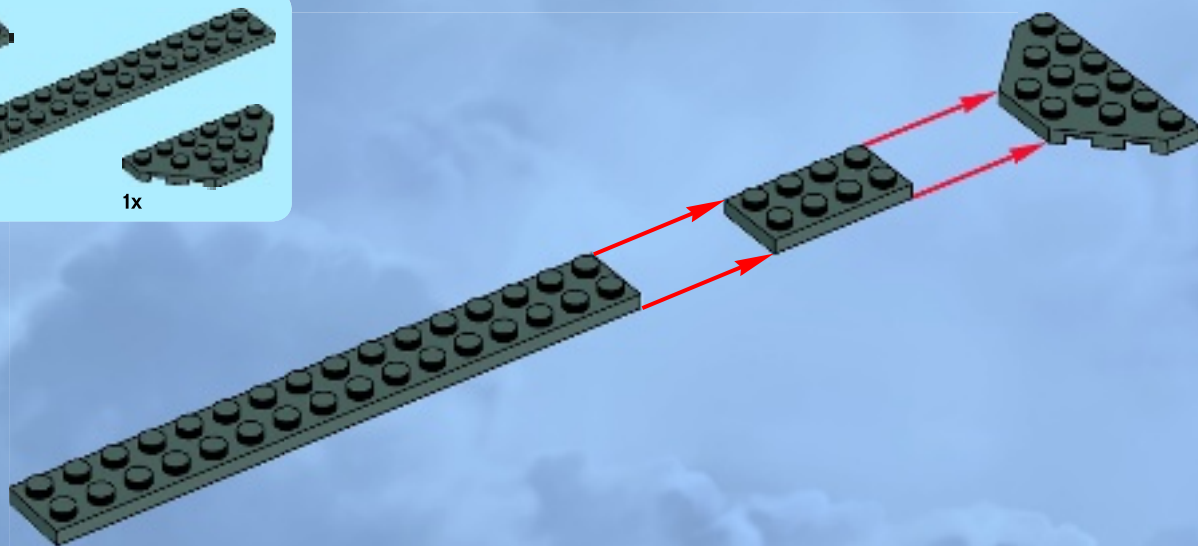

2

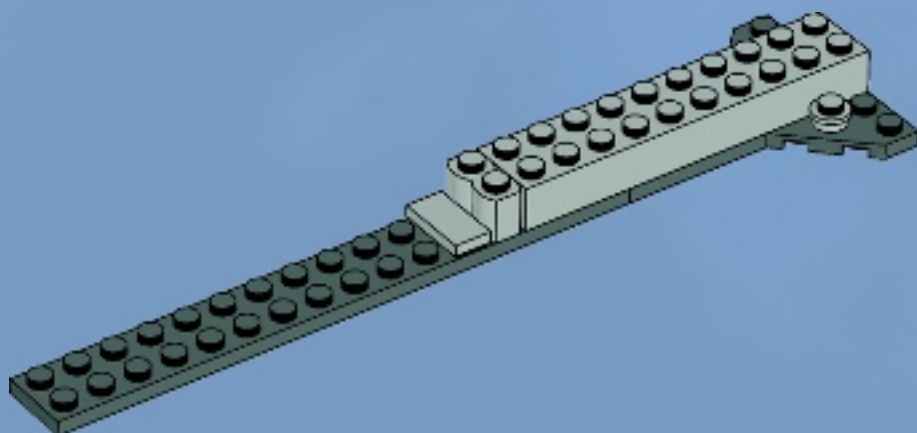

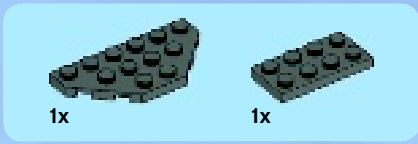

3

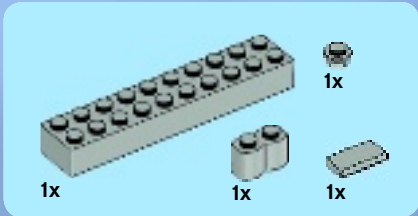
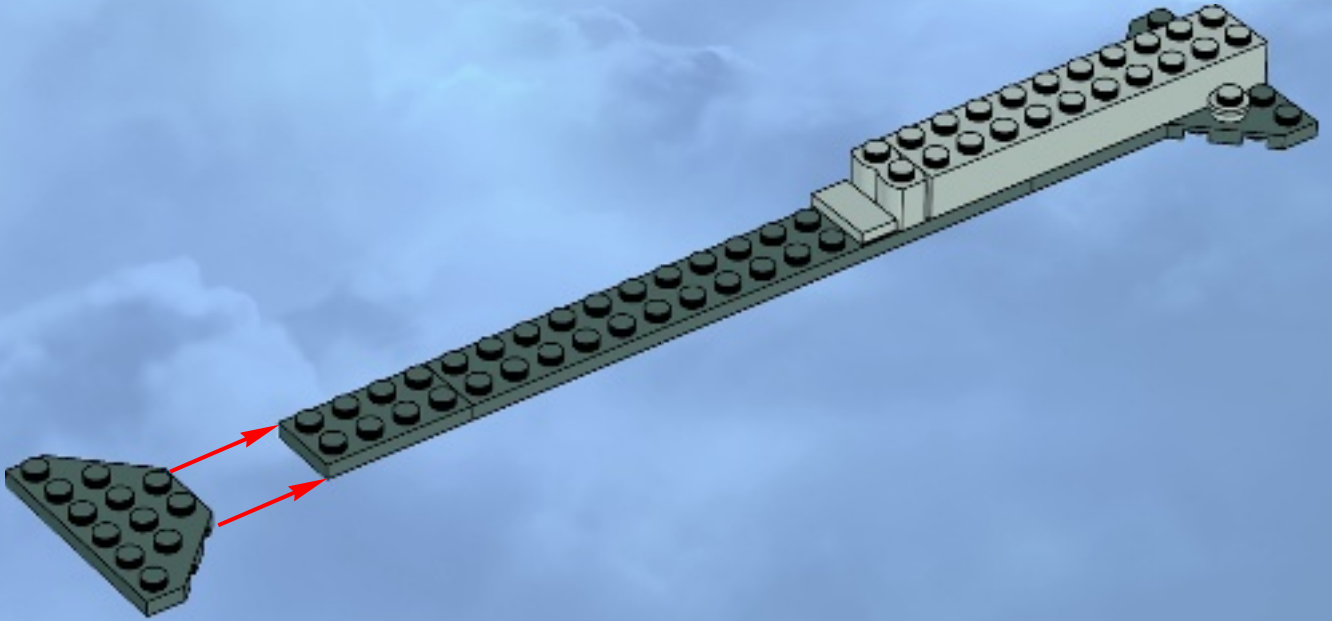

4

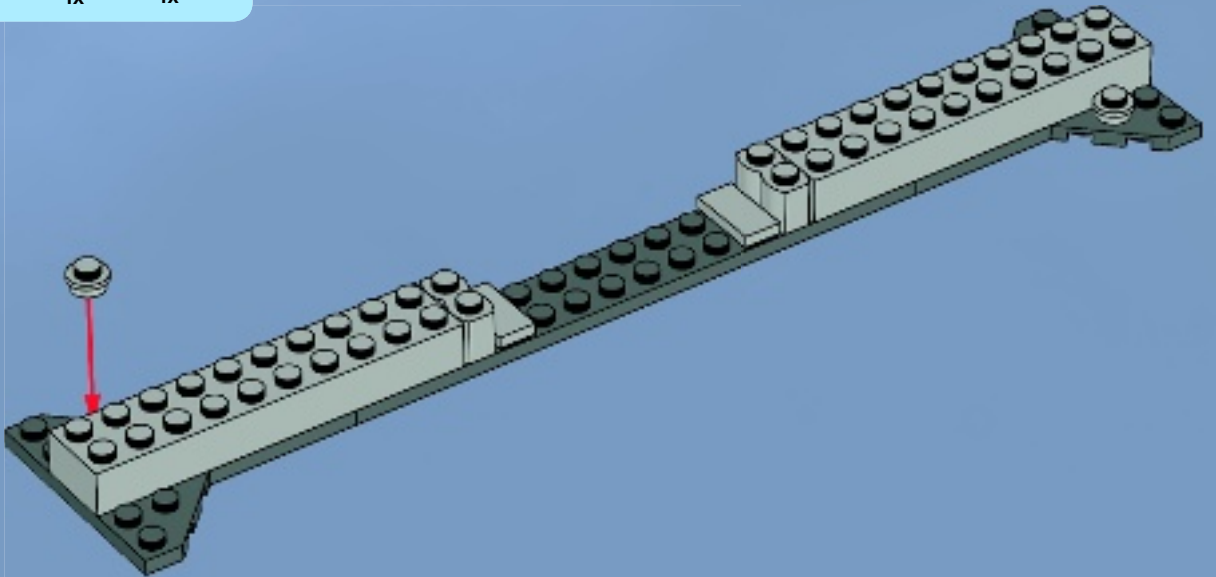



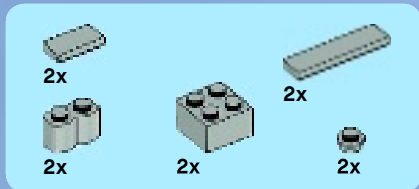

5

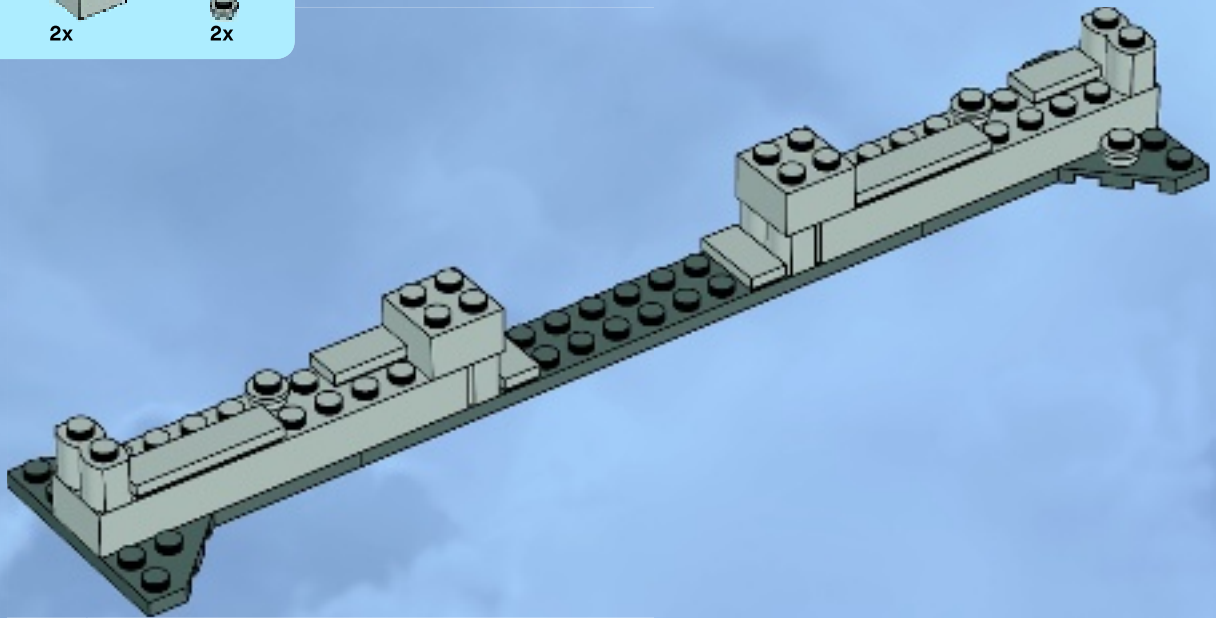

6

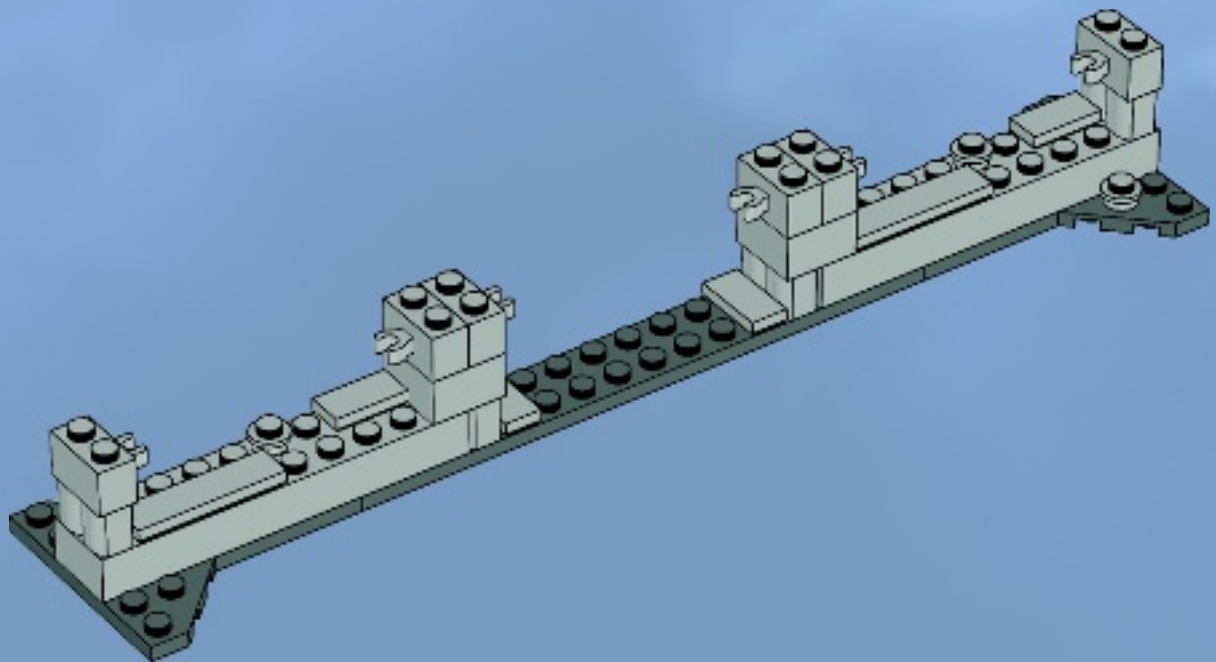



2x



2x

7

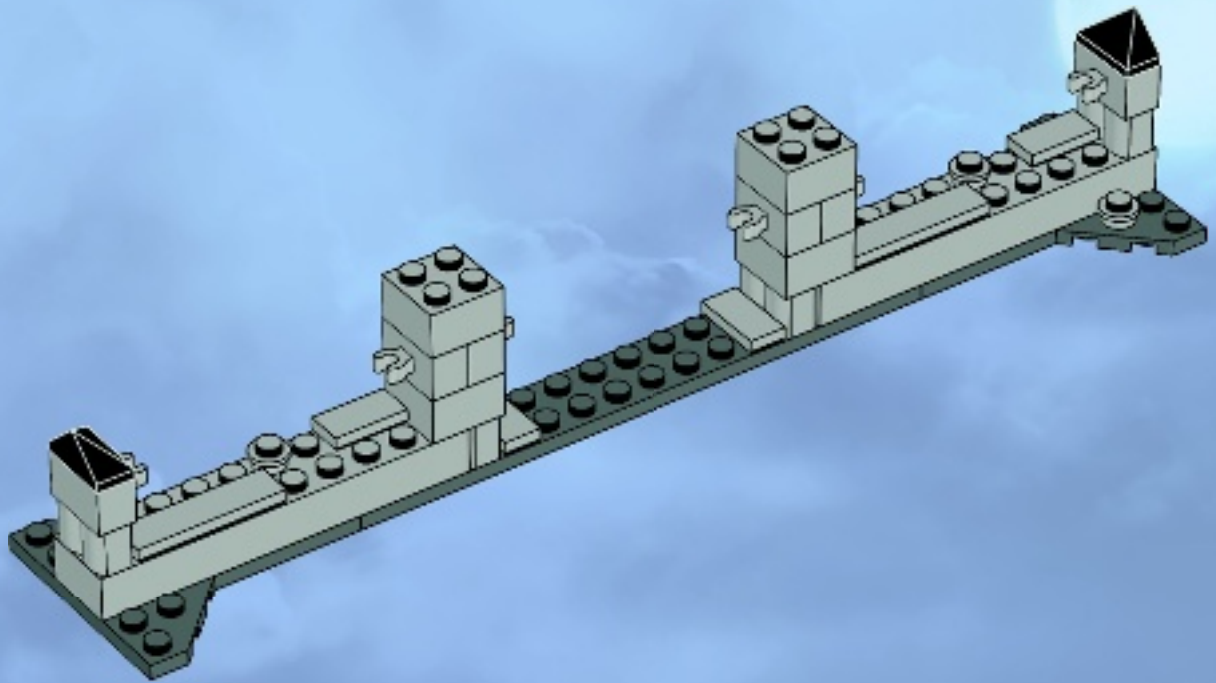

2x



2x

8

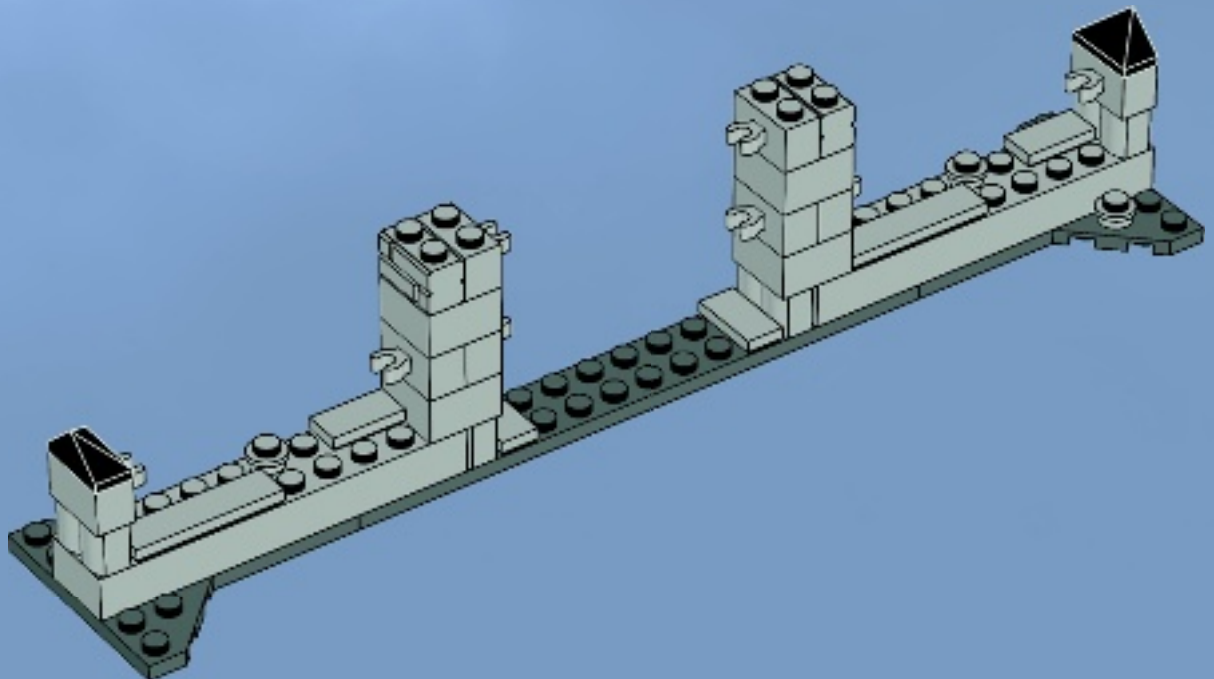



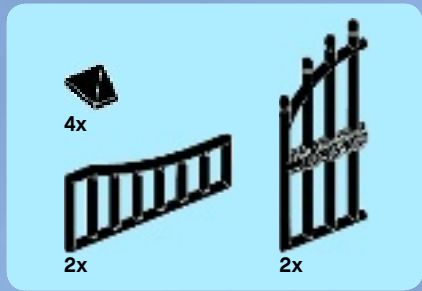

9

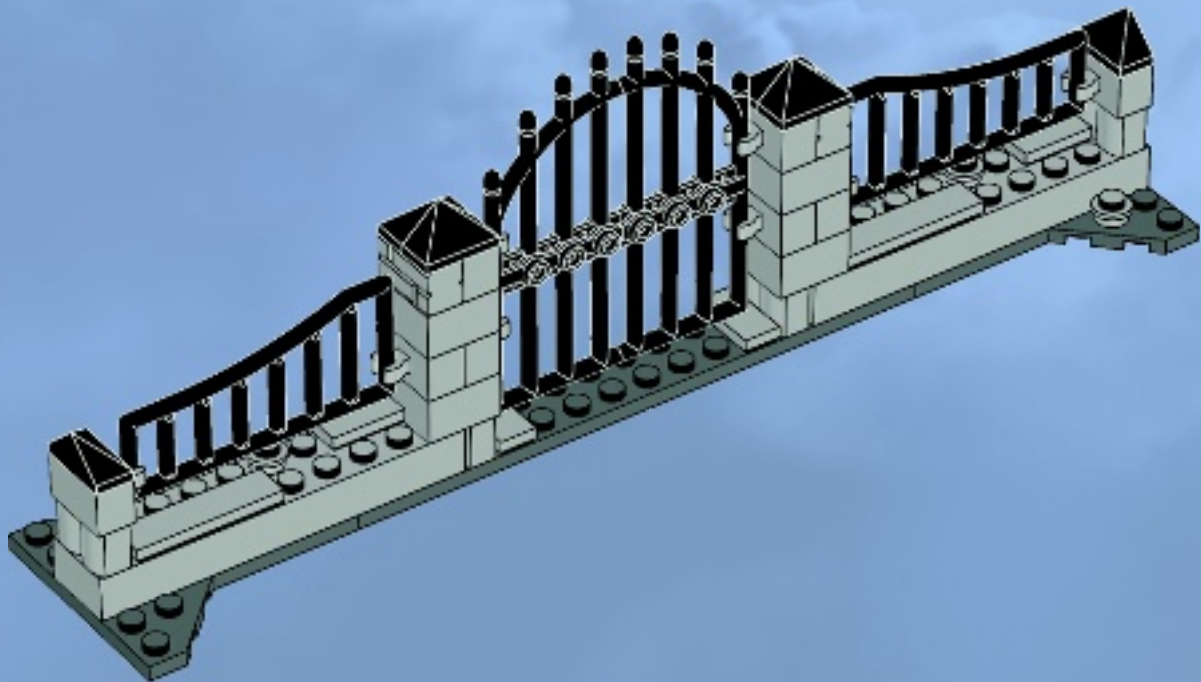

146

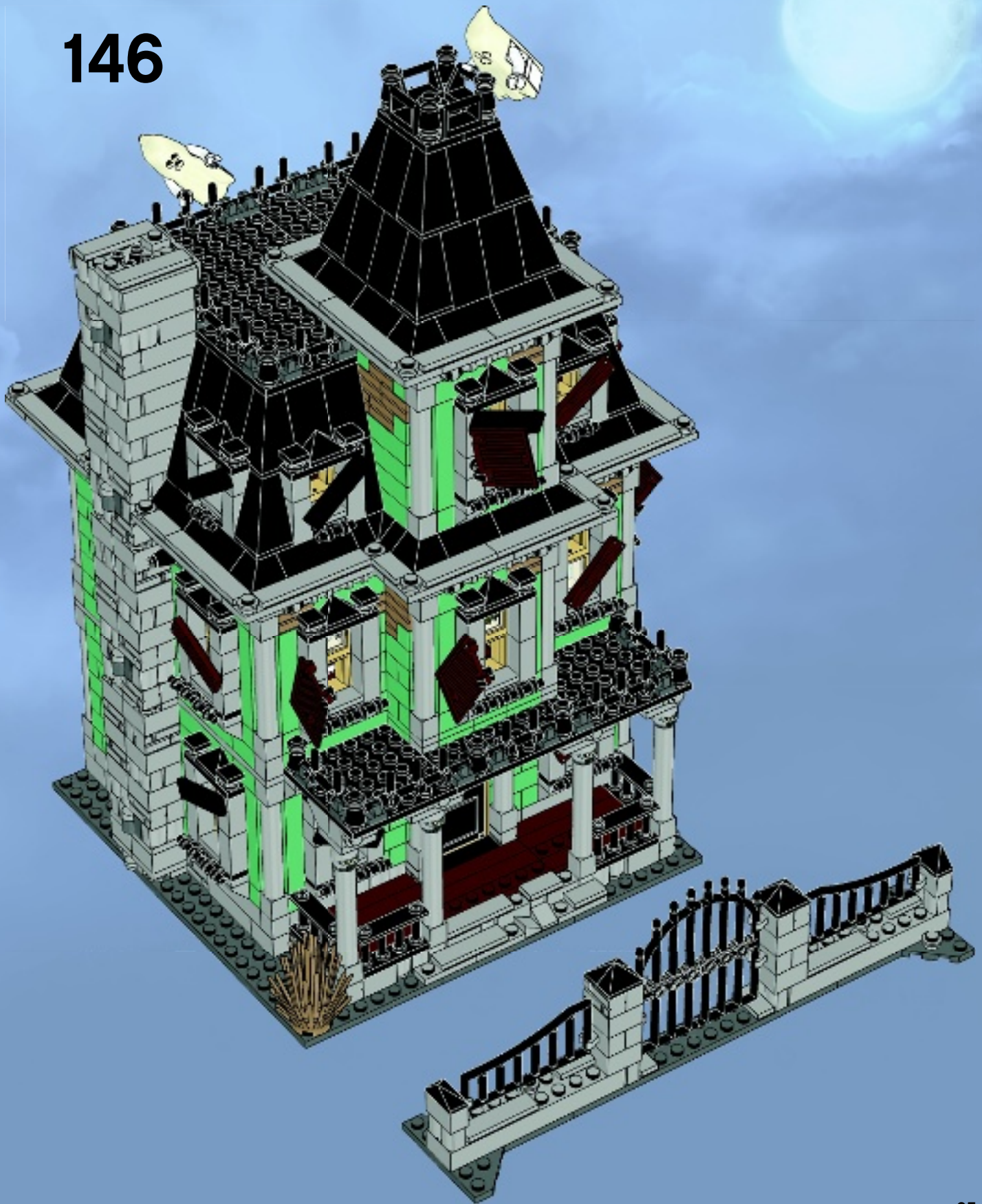



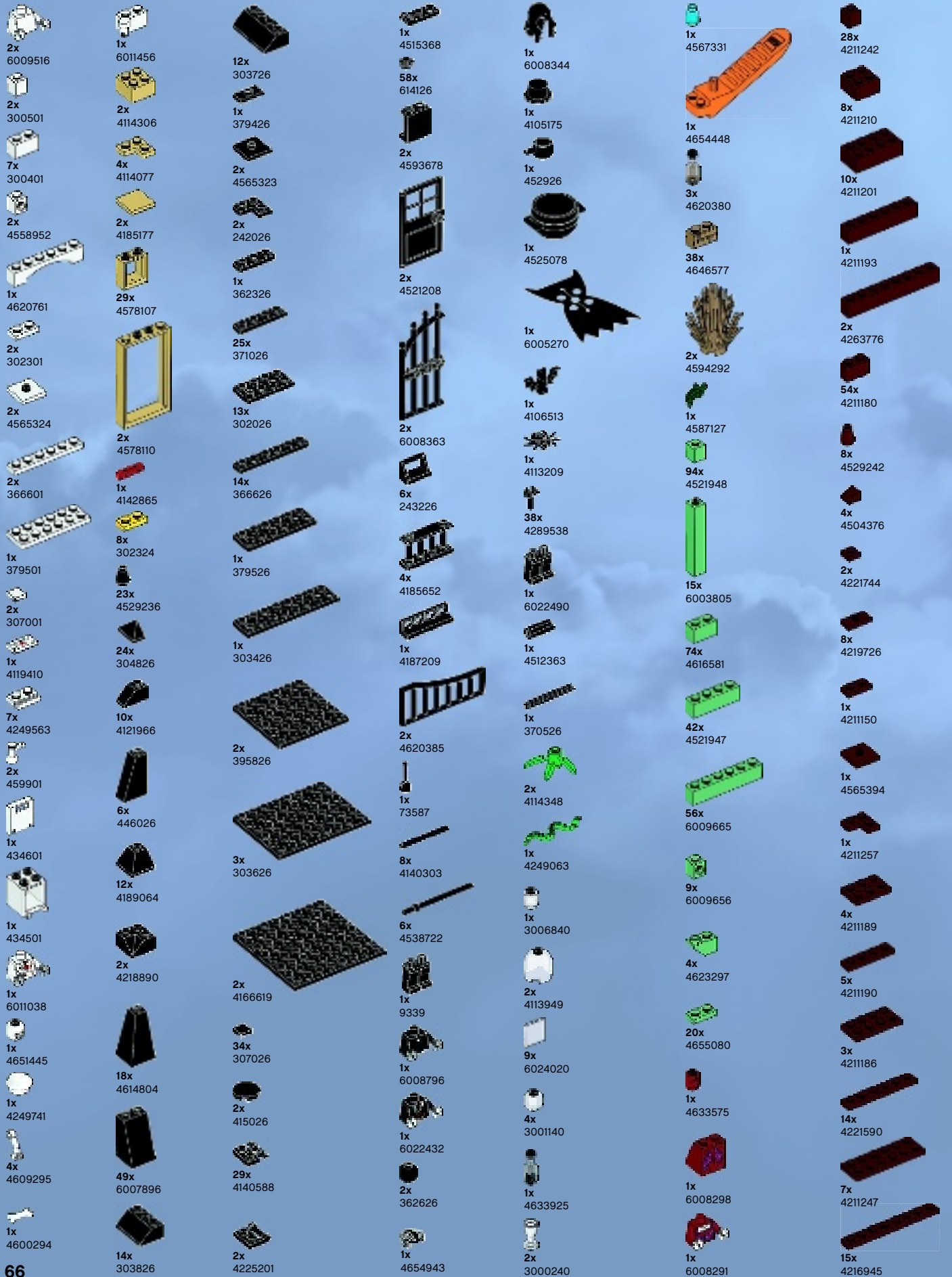

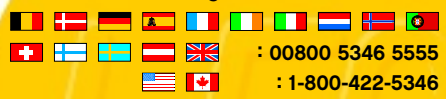
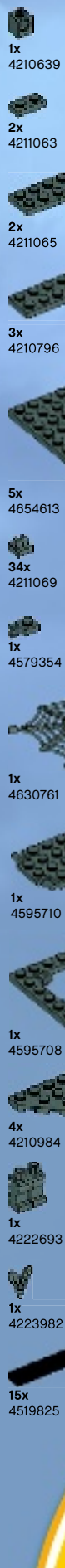
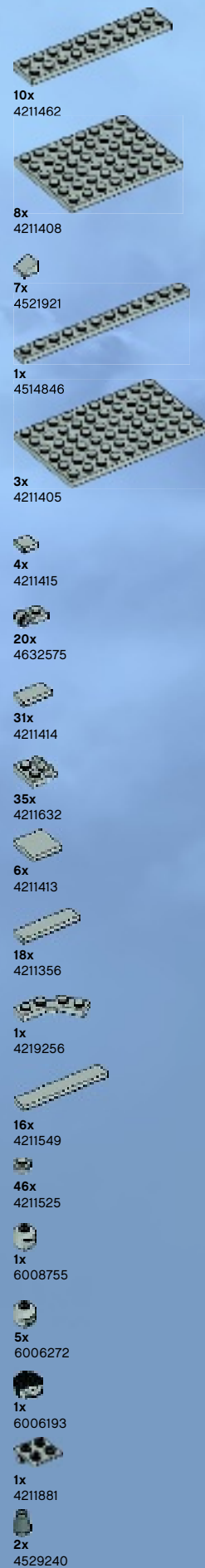
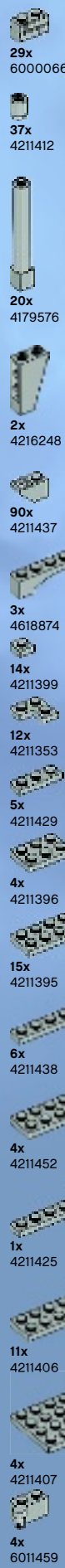





# WIN!

Go to [www.LEGOsurvey.com/product](http://www.LEGOsurvey.com/product) to fill out a survey for a chance to win a cool LEGO® Product.

No purchase necessary.

Open to all residents where not prohibited.

 [www.LEGO.com](http://www.LEGO.com)



## [www.LEGOsurvey.com/product](http://www.LEGOsurvey.com/product)

### GEWINNE!

Nimm an der Umfrage auf [www.LEGOsurvey.com/product](http://www.LEGOsurvey.com/product) teil und hab die Chance ein cooles LEGO® Produkt zu gewinnen!  
Die Teilnahme am Gewinnspiel führt zu keinerlei Kaufverpflichtungen. Teilnahme in allen nicht ausgeschlossenen Ländern möglich.

### WIN!

Ga naar [www.LEGOsurvey.com/product](http://www.LEGOsurvey.com/product), vul een enquêteformulier in en maak kans op een cool LEGO® product.  
Geen aankoopverplichting.  
Iedereen mag deelnemen, uitgezonderd ingezetenden van landen waar een enquêteverbod geldt.

### GAGNE!

Visite [www.LEGOsurvey.com/product](http://www.LEGOsurvey.com/product) pour répondre à un questionnaire et avoir une chance de gagner un produit LEGO® très cool!  
Aucune obligation d'achat.  
Ouvert à tous les résidents des pays autorisés.

### 当てよう!

[www.LEGOsurvey.com/product](http://www.LEGOsurvey.com/product) にアクセスして、アンケートにご記入ください。当選者にはレゴ®製品を差し上げます。  
お買い上げの必要はありません。  
禁止されていない限り、すべての皆様にご利用いただけます。