

RIVAL 600

PRODUCT INFORMATION GUIDE

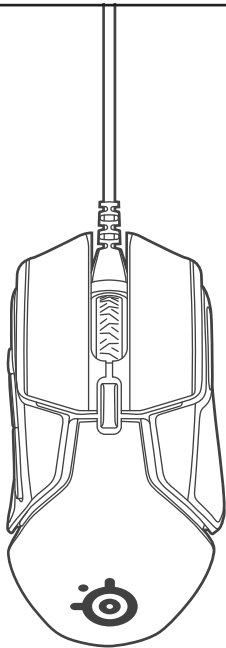

WELCOME TO RIVAL 600

The Rival 600 gaming mouse combines true 1 to 1 tracking with an advanced dual-optical sensor system that enables precise liftoff distance calibration. Plus, 256 weight combinations enable you to custom-tune the perfect balance.

Like you, we are esports pros, pubstars, 5am raiders, 1hp heroes, streamers and dreamers. Your Rival 600 was forged out of our belief that gaming isn't your way to escape reality, it's your path to rewrite it.

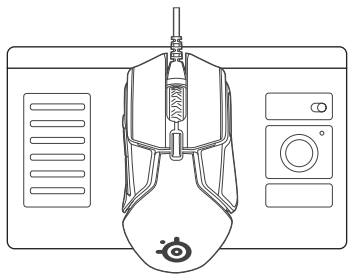

STEELSERIES ENGINE

Download SteelSeries Engine to **control the Wireless Transmitter** from PC, and to **integrate with Engine Apps** (like displaying Discord info on the OLED screen). steelseries.com/engine

SOFTWARE REQUIREMENTS

Platforms

- Windows 7 +
- Mac OS X 10.8 +

120 MB of free hard drive space for installation

*DTS Headphone:X 7.1 Surround available on Windows only. Software installation required.

SETUP

find help at support.steelseries.com

PACKAGE CONTENTS

Rival 600 Mouse

Product Information Guide

Weights box

8x 3.75 g weights

HARDWARE INSTALLATION

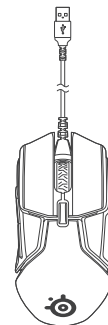
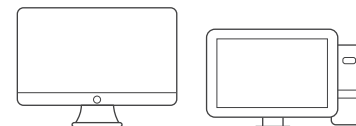

PRODUCT OVERVIEW

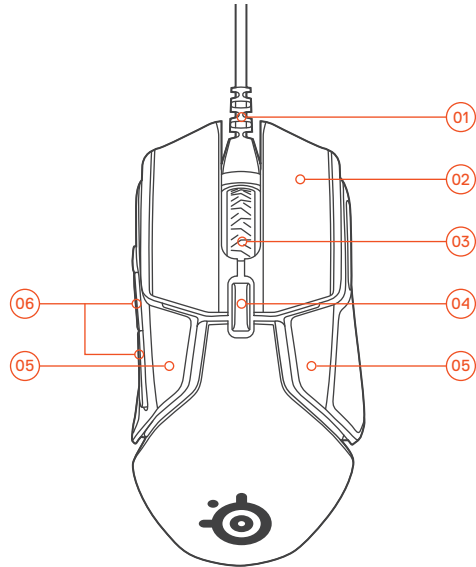

- 01 Removable Cable *
- 02 Split Trigger Design
Main Mouse Buttons
- 03 Scroll Wheel
- 04 CPI Button /
Lift Off Calibration
- 05 Removable Side Panels
with Rubber Side Grips *
- 06 Side Buttons

* Find accessories and replacement parts at steelseries.com/gaming-accessories



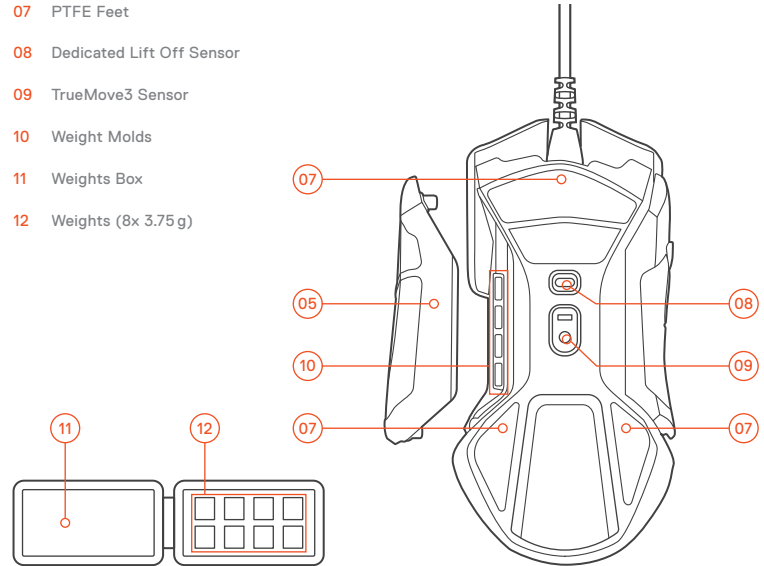

- 07 PTFE Feet
- 08 Dedicated Lift Off Sensor
- 09 TrueMove3 Sensor
- 10 Weight Molds
- 11 Weights Box
- 12 Weights (8x 3.75 g)

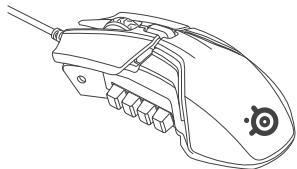
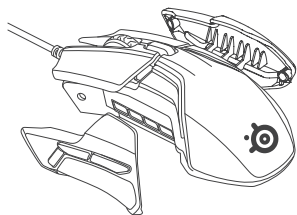

find help at support.steelseries.com

CONFIGURING WEIGHT SYSTEM



- 01** Remove the side panels  to access the weight molds
- 02** Choose your desired weights  and insert them into the dedicated molds 
- 03** Re-attach side panels  once the desired weight is calibrated. If you find it not to your liking, repeat steps 01 to 03

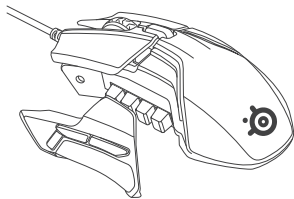

CALIBRATION OF LIFT OFF SENSOR

Your Rival 600 is equipped with a secondary, high precision lift off sensor. To ensure the highest level of accuracy, the lift off sensor must be calibrated to your gaming surface of choice.

By default your Rival 600 is set to a ~0.5 mm lift off distance. SteelSeries Engine offers the ability to further tweak the lift off distance.

Calibration of the lift off sensor can happen in two ways:

Automatic

On every mouse power up (for instance, plugging in the USB cable), your lift off sensor will automatically calibrate.

find help at support.steelseries.com

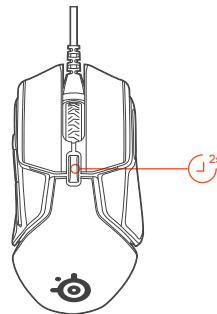

Manual

If you change gaming surfaces it is recommended to recalibrate the lift off sensor.

To manually calibrate the lift off sensor, hold down the CPI button  for two seconds to force recalibration. Your Rival 600 will flash white three times when lift off calibration is complete.

ESPAÑOL

Contenido del paquete

Mouse Rival 600

Guía de información sobre el producto

Recipiente para el peso

Peso de 8 x 3,75 g

Requisitos del sistema // Compatibilidad

PC/Mac

Requisitos de software de SteelSeries Engine

Plataformas

Windows 7 o superior

Mac OS X 10.8 o superior

120 MB de espacio libre en el disco duro para la instalación

más información en support.steelseries.com

DESCRIPCIÓN GENERAL DEL PRODUCTO

- 01 Cable desmontable*
- 02 Diseño de gatillos separados Botones principales del mouse
- 03 Rueda del mouse
- 04 Botón de CPI/Calibración desmontable

05 Paneles laterales desmontables con agarres laterales de goma*

06 Botones laterales

07 Base de politetrafluoretileno

08 Sensor desmontable dedicado

09 Sensor TrueMove3

10 Moldes de peso

11 Recipiente para el peso

12 Peso (8 x 3,75 g)

* Encuentre accesorios y repuestos en steelseries.com/gaming-accessories

CONFIGURACIÓN

Instalación de hardware

Configuración del sistema de peso

- 01 Retire los paneles laterales (🔒) para acceder a los moldes de peso
- 02 Elija los pesos deseados (🔘) e introdúzcalos en los moldes dedicados (🔒)
- 03 Vuelva a conectar los paneles laterales (🔒) una vez que se calibre el peso deseado. Si finalmente no está satisfecho, repita los pasos 01 al 03

más información en support.steelseries.com

Calibración del sensor desmontable

Rival 600 cuenta con un sensor desmontable secundario de alta precisión. Para garantizar el máximo nivel de precisión, debe calibrar el sensor desmontable de su superficie de juego a su conveniencia.

Rival 600 está calibrado de forma predeterminada con una distancia de desmontaje de aproximadamente 0,5 mm. SteelSeries Engine ofrece la capacidad de modificar la distancia de desmontaje.

Se puede calibrar el sensor desmontable de dos maneras:

简体中文

包装内容

Rival 600鼠标

产品信息指南

配重盒

8x 3.75g配重砝码

系统要求//兼容性

PC / Mac

SteelSeries Engine软件要求

Automáticamente

Cada vez que encienda el mouse (por ejemplo, cuando se conecta el cable USB), su sensor desmontable se calibra automáticamente.

Manualmente

Si cambia de superficie de juego, se recomienda volver a calibrar el sensor desmontable.

Para calibrar manualmente el sensor desmontable, mantenga presionado el botón de CPI durante dos segundos para forzar la recalibración. Rival 600 mostrará una luz blanca tres veces cuando se complete la calibración desmontable.

操作系统

Windows 7 +

Mac OS X 10.8 +

120MB的可用硬盘空间

在support.steelseries.com寻求帮助

产品概述

- 01 可拆卸线缆*
- 02 分体式设计按键
- 03 滚轮

04 CPI按钮/响应高度校准

05 可拆卸防滑橡胶侧裙*

06 侧面按键

07 PTFE脚贴

08 专用高度传感器

09 TrueMove3传感器

10 配重模块

11 配重盒

12 配重砝码(8x 3.75 g)

*在[steelseries.com/gaming-accessories](https://support.steelseries.com/gaming-accessories)查找配件和零件

设置

硬件安装

设置配重系统

01 拆掉侧裙[Ⓞ]，找到配重模块

02 选择您需要的砝码[Ⓞ]，将它们插入专用模块中[Ⓞ]

03 调整好配重后重新安装上侧板[Ⓞ]。如果觉得配重仍不合适，重复步骤01到03

在support.steelseries.com寻求帮助

响应高度传感器校准

您的Rival 600配有额外的高精度高度传感器。如要获得最高水准的鼠标精度，则必须校准高度传感器，以使之适应所用鼠标垫。

您的Rival 600的响应高度的默认值为-0.5mm。SteelSeries Engine提供进一步调整响应高度的功能。

高度传感器校准有两种方法：

自动

每次鼠标通电（例如插入USB线缆），高度传感器即会自动校准。

手动

如果您的鼠标垫改变，建议您重新校准高度传感器。

要校准高度传感器，按下CPI按钮两秒以启动强制校准。校准结束时，您的Rival 600会闪白灯三下。

繁體中文

包裝內容

Rival 600滑鼠

產品信息指南

配重盒

8x 3.75 g砝碼

系統要求//兼容性

PC / Mac

SteelSeries Engine軟體要求

操作系統

Windows 7 +

Mac OS X 10.8 +

安裝需要120MB硬碟空間

訪問support.steelseries.com尋求幫助

產品概覽

01 可拆卸線纜*

02 分離式滑鼠按鍵

03 滾輪

04 CPI按钮/抬起高度校准

05 可拆卸侧板，含橡胶侧防滑垫*

06 侧键

07 PTFE脚垫

08 专用高度传感器

09 TrueMove3传感器

10 配重模块

11 配重盒

12 配重砝码(8x 3.75 g)

*在steelseries.com/gaming-accessories查找配件和零件

設置

硬碟安裝

配置配重系統

01 拆掉側板[Ⓞ]，找到配重模塊

02 選擇您需要的配重砝碼[Ⓞ]，將它們插入專用模塊中[Ⓞ]

03 所需配重校準後，重新安裝上側板[Ⓞ]。如果覺得配重仍不合適，重複步驟01到03

在support.steelseries.com尋求幫助

滑鼠騰空感測器校準

您的Rival 600配有額外的高精度高度感測器。如要獲得最高水準的精準度，則必須校準高度傳測器，以使之適應所選用滑鼠墊表面。

您的Rival 600的抬起高度的初始值為~0.5mm。SteelSeries Engine提供進一步調整選擇距離的功能。

高度感測器校準有兩種方法：

自動

每次滑鼠通電（例如插入USB線），高度感測器即會自動校準。

手動

如果您的鼠標墊表面改變，建議您重新校準高度感測器。

要校準高度感測器，按下CPI按鍵兩秒以啟動強制校準。校準結束時，您的Rival 600會閃白燈三下。

が必要です。

support.steelseries.comにアクセスして、その他の提案やサポートをご覧ください

製品の概要

- 01 リムーバブルケーブル*
- 02 スプリット・トリガーデザイン・メインマウスボタン
- 03 スクロールホイール
- 04 CPIボタン/リフトオフキャリブレーション
- 05 ラバーサイドグリップ付きの取り外し可能なサイドパネル*
- 06 サイドボタン
- 07 PTFEフィート

日本語

パッケージの内容

Rival 600 マウス

製品情報ガイド

ウエイトボックス

8x 3.75g 重量

動作環境//互換性

PC / Mac

SteelSeries Engineソフトウェア条件

プラットフォーム

Windows 7 +

Mac OS X 10.8 +

インストールに120 MBのハードディスク空き容量

08 専用リフトオフセンサー

09 TrueMove3センサー

10 ウェイト差込口

11 ウェイトボックス

12 ウェイト (8x 3.75g)

* アクセサリーや交換部品をお求めの場合は、steelseries.com/gaming-accessoriesで情報をご覧ください。

設定

ハードウェアのインストール

ウェイトシステムの設定

- 01 ウェイト差込口にアクセスするためにサイドパネルⓄを取り外します
- 02 ご希望のウェイトⓄを選択し、専用ウェイト差込口Ⓞに挿入します。
- 03 ご希望のウェイトが決まったら、サイドパネルⓄを取り付けます。お好みに合っていない場合は、手順01-03を再度おこなってください support.steelseries.comにアクセスして、その他の提案やサポートをご覧ください

リフトオフセンサーの調整

Rival 600には、高精度リフトオフセンサーが搭載

されています。最高レベルの精度を確保するには、リフトオフセンサーをマウスパッド表面に合わせて調整する必要があります。

デフォルトでRival 600は~0.5mmのリフトオフディスタンスに設定されています。SteelSeries Engineを使うことで、さらに細かくリフトオフディスタンスの調整ができます。

リフトオフセンサの調整は、以下の2つの方法で行うことができます。

オートマッチック

マウスの電源を入れるたびに（USBケーブルを差し込むなど）、リフトオフセンサーが自動的に校正されます。

マニュアル

マウスパッドを変更する場合は、リフトオフセンサーを再調整することをお勧めします。

リフトオフセンサーを手動で調整するには、CPIボタンを2秒間押し続けると、再調整が強制的に実行されます。リフトオフの調整が完了すると、Rival 600は白く3回点滅します。

한국어

패키지 내용물

Rival 600 마우스

제품 정보 가이드

무게추 박스

3.75g 무게추 8개

시스템 요구사항 // 호환성

PC / Mac

SteelSeries Engine 소프트웨어 요구사항

플랫폼

Windows 7 이상

Mac OS X 10.8 이상

120MB의 설치용 하드 드라이브 공간

고객 지원은 support.steelseries.com을 방문하세요

제품 개요

01 탈착형 케이블 *

02 겹 방아쇠 디자인의 주 마우스 버튼

03 스크롤 휠

04 CPI 버튼 / 지면 거리 조정

05 고무 그림이 부착된 탈착형 측면 패널 *

06 측면 버튼

07 PTFE 소재 피트

08 지면 거리 전담 센서

09 TrueMove3 센서

10 무게추 홈

11 무게추 박스

12 무게추(3.75g 8x)

* 액세서리와 대체 부품은 steelseries.com/gaming-accessories에서 구하세요

셋업

하드웨어 설치

무게 시스템 설정

01 측면 패널(Ⓜ)을 탈착하여 무게추 홈을 드러내세요

02 원하는 대로 무게추(Ⓜ)를 전담 홈(Ⓜ)에 끼우세요

03 원하는 무게 균형을 갖춘 다음 측면 패널을 다시 부착시키세요. 결과가 마음에 들지 않을 경우, 01에서 03 단계를 다시 반복하세요

고객 지원은 support.steelseries.com을 방문하세요

지면 거리 센서 조정

Rival 600은 부가적인 초정밀 지면 거리 센서가 탑재되어 있습니다. 높은 정확성을 확보하려면 사용자가 게이밍에 사용하는 표면에 맞추어 지면 거리 센서를 조정할 필요가 있습니다.

Rival 600의 지면 거리의 기본값은 0.5mm으로 설정되어 있습니다. SteelSeries Engine은 지면 거리의 미세한 조정을 가능하게 합니다.

지면 거리 센서의 조정에는 두 가지 방법이 있습니다:

자동

DEUTSCH

In der Packung

Rival 600 Maus

Informationsleitfaden über das Produkt

Schachtel mit Gewichten

8x 3,75 g Gewichte

Systemanforderungen // Kompatibilität

PC / Mac

Softwareanforderungen für die SteelSeries Engine

Plattformen

Windows 7 +

마우스에 전원이 들어올 때마다(예를 들어 USB 케이블을 꽂을 때) 지면 거리 센서가 자동으로 조정합니다.

수동

게이밍에 사용하는 표면을 변경 시 지면 거리 센서를 재조정하는 것이 권장됩니다.

지면 거리 센서를 수동으로 조정하려면, CPI 버튼을 2초 동안 눌러서 강제 재조정을 작동시키십시오. 조정이 끝나면 Rival 600 마우스가 흰색으로 세 번 깜박일 것입니다.

Mac OS X 10.8 +

120 MB freier Festplattenspeicherplatz zur Installation

Sie brauchen Hilfe? support.steelseries.com

PRODUKT IM ÜBERBLICK

01 Abnehmbares Kabel *

02 Hauptmaustasten mit getrenntem Auslöser

03 Scroll-Rad

04 CPI-Taste / Lift-Off-Kalibrierung

05 Abnehmbare Seitenabdeckungen mit Kunststoff-Seitengriffen *

06 Seitentasten

07 PTFE-Füße

08 Spezifischer Lift-Off-Sensor

09 TrueMove3-Sensor

10 Gewicht-Formen

11 Schachtel mit Gewichten

12 Gewichte (8x 3,75 g)

*Zubehör und Ersatzteile finden Sie bei steelseries.com/gaming-accessories

EINRICHTUNG

Hardware-Installation

Konfiguration des Gewichtssystems

01 Nehmen Sie die Seitenabdeckungen  ab um die Gewicht-Mulden freizulegen.

02 Wählen Sie die gewünschten Gewichte  und stecken Sie sie in die entsprechenden Formen .

03 Befestigen Sie die Seitenabdeckungen  erneut, sobald das gewünschte Gewicht kalibriert wurde. Falls es Ihnen nicht zusagt, wiederholen Sie Schritte 01 bis 03.

Sie brauchen Hilfe? support.steelseries.com

Kalibrierung von Lift-Off-Sensor

Ihre Rival 600 ist mit einem sekundären, Hochpräzisions-Lift-Off-Sensor ausgestattet. Um den höchst möglichen Präzisionsgrad zu gewährleisten, muss der Lift-Off-Sensor auf die gewünschte Gaming-Oberfläche kalibriert werden.

Standardmäßig ist Ihre Rival 600 auf eine Lift-Off-Distanz von ~0,5mm eingestellt. Mit der SteelSeries Engine lässt sich die Distanz noch weiter einstellen.

Die Kalibrierung kann in zwei verschiedenen Arten erfolgen:

Automatisch

Bei jedem Einschalten der Maus (beispielsweise beim Einstecken des USB-Kabels), wird Ihr Lift-Off-Sensor automatisch kalibriert.

Manuell

Wenn Sie auf anderen Gaming-Oberflächen spielen, wird empfohlen, den Lift-Off-Sensor neu zu kalibrieren.

Halten Sie zum manuellen Kalibrieren des Lift-Off-Sensors die CPI-Taste zwei Sekunden lang gedrückt, um eine neue Kalibrierung zu erzwingen. Ihre Rival 600 wird dreimal weiß aufleuchten, dann ist die Lift-Off-Kalibrierung abgeschlossen.

РУССКИЙ

Содержимое упаковки

Мышь Rival 600

Руководство пользователя

Коробка для гирек

8 гирек по 3,75 г

Системные требования // Совместимость

ПК / Мак

Системные требования для программы SteelSeries Engine

Платформы

Windows 7 +

Mac OS X 10.8 +

120 МБ свободного места на жёстком диске для установки

Помощь: support.steelseries.com

ОБ ИЗДЕЛИИ

01 Съёмный кабель*

02 Основные разделённые кнопки мыши

03 Колесо прокрутки

04 Кнопка ЗНД и калибровки подъёма

05 Съёмные боковые панели с резиновыми вставками*

06 Боковые кнопки

07 Ножки из ПТФЭ

08 Отдельный датчик подъёма

09 Датчик TrueMove3

10 Гнёзда для гирек

11 Коробка для гирек

12 Гирьки (8 по 3,75 г)



* Аксессуары и запчасти можно купить на сайте steelseries.com/gaming-accessories

УСТАНОВКА

Установка оборудования

Настройка веса

01 Снимите боковые панели , чтобы открыть гнёзда для гирек

02 Выберите нужное кол-во гирек  и вставьте в гнёзда .

03 Задав нужный вес, установите боковые панели  обратно. Если вес не подходит, повторите шаги 01-03

Помощь: support.steelseries.com

Калибровка датчика подъёма

У мыши Rival 600 есть второй высокоточный датчик подъёма. Чтобы он работал наилучшим образом, его нужно откалибровать в соответствии с вашей игровой поверхностью.

По умолчанию подъём мыши Rival 600 установлен на ~0,5 мм. В службе SteelSeries Engine можно задать иное расстояние подъёма.

Есть 2 способа калибровки датчика подъёма:

FRANÇAIS

Contenu de l'emballage

Souris Rival 600

Guide d'informations produit

Boîte de poids

8 poids de 3,75 g

Configuration requise // Compatibilité

PC / Mac

Configuration requise pour le logiciel SteelSeries Engine

Plateformes

Автоматический

При каждом включении мыши (например, при соединении USB-кабеля) датчик подъёма откалибруется сам.

Ручной

Рекомендуется откалибровать датчик заново при смене игровой поверхности.

Чтобы откалибровать датчик вручную, нажмите кнопку ЗНД на 2 секунды: это запустит процесс калибровки. По окончании мышь Rival 600 три раза мигнёт белым светом.

Windows 7 +
Mac OS X 10.8 +

120 Mo d'espace libre sur le disque dur pour l'installation

assistance disponible à l'adresse support.steelseries.com

Vue d'ensemble du produit

01 Câble amovible *

02 Boutons principaux de la souris en gâchette scindée

03 Molette de défilement

04 Bouton CPP / Calibration du soulèvement

05 Panneaux latéraux amovibles avec prises latérales en caoutchouc

06 Boutons latéraux

07 Pattes en PTFE

08 Capteur de soulèvement dédié

09 Capteur TrueMove3

10 Moules à poids

11 Boîte de poids

12 Poids (8 x 3,75 g)

* Accessoires et pièces de rechange disponibles à l'adresse steelseries.com/gaming-accessories

INSTALLATION

Installation de matériel

Configuration du système de poids

01 Ôtez les panneaux latéraux  pour accéder aux moules à poids

02 Choisissez les poids  que vous souhaitez utiliser et insérez-les dans les moules  prévus à cet effet

03 Remettez en place les panneaux latéraux  une fois que le poids souhaité est calibré. S'il ne vous

convient pas, répétez les étapes 01 à 03

assistance disponible à l'adresse support.steelseries.com

Calibrage du capteur de soulèvement

Votre souris Rival 600 est équipée d'un capteur secondaire de haute précision dédié au soulèvement. Pour garantir un degré de précision optimal, le capteur de soulèvement doit être calibré par rapport à la surface de jeu de votre choix.

La distance de soulèvement par défaut de votre Rival 600 est de ~0,5 mm. Vous avez la possibilité d'ajuster la distance de soulèvement au moyen de SteelSeries Engine.

Le calibrage du capteur de soulèvement peut être effectué de deux manières :

Automatique

À chaque fois que la souris est allumée (lorsque le câble USB est branché, par exemple), votre capteur de soulèvement sera automatiquement calibré.

Manuel

Il est recommandé de recalibrer le capteur de soulèvement si vous changez de surface de jeu.

Pour le calibrage manuel du capteur de soulèvement, maintenez le bouton CPP appuyé pendant deux secondes pour induire le calibrage. Votre Rival 600 clignotera trois fois d'une lumière blanche lorsque le calibrage sera terminé.

ITALIANO

Contenuto della confezione

Mouse Rival 600

Guida informazioni sul prodotto

Scatola dei pesi

8 x 3,75 g di peso

Requisiti di sistema // Compatibilità

PC / Mac

Requisiti del software SteelSeries Engine

Piattaforme

Windows 7 +

Mac OS X 10.8 +

120 MB di spazio libero su disco per l'installazione

Per assistenza visita support.steelseries.com

GENERALITÀ SUL PRODOTTO

01 Cavo removibile*

02 Pulsanti mouse principali con trigger separato

03 Rotella di scorrimento

04 Pulsante CPI / Calibrazione del sollevamento

05 Sportelli laterali removibili con impugnature laterali in gomma*

06 Pulsanti laterali

07 Piedini in PTFE

08 Sensore di sollevamento dedicato

09 Sensore TrueMove3

10 Vani dei pesi

11 Scatola dei pesi

12 Pesi (8 x 3,75 g)

* Trova accessori e parti di ricambio su steelseries.com/gaming-accessories

MONTAGGIO

Installazione dell'hardware

Sistema di configurazione dei pesi

01 Rimuovi gli sportelli laterali (🔓) per accedere ai vani dei pesi

02 Scegli i pesi desiderati (🔒) quindi inseriscili negli appositi vani (🔓)

03 Una volta calibrato il peso desiderato richiudi gli sportelli laterali (🔒). Se non ti dovesse andar bene, ripeti tutti i passaggi da 01 a 03

Per assistenza visita support.steelseries.com

Calibrazione del sensore di sollevamento

Il Rival 600 è dotato di un sensore di sollevamento secondario ad alta precisione. Per garantire il massimo livello di precisione, il sensore di sollevamento deve essere calibrato sulla superficie di gioco scelta.

Per impostazione predefinita, il Rival 600 è impostato su una distanza di sollevamento di ~ 0,5 mm. SteelSeries Engine offre la possibilità di regolare ulteriormente la distanza di sollevamento.

La calibrazione del sensore di sollevamento può essere effettuata in due modi:

Automatico

Il sensore di sollevamento viene automaticamente calibrato ogni volta che si accende il mouse (ad esempio, collegando il cavo USB).

Manuale

Nel caso in cui dovessi cambiare superficie di gioco sarebbe opportuno che ricalibrassi il sensore di sollevamento.

Per calibrare manualmente il sensore di sollevamento e quindi indurre la ricalibrazione, tieni premuto il pulsante CPI per due secondi. Il Rival 600 lampeggerà tre volte di bianco quando la calibrazione del sollevamento sarà completata.

PORTUGUÊS

Conteúdo da embalagem

Mouse Rival 600

Guia de informações do produto

Caixa de pesos

8 pesos de 3,75 g

Requisitos do sistema // Compatibilidade

PC / Mac

Requisitos do software SteelSeries Engine

Plataformas

Windows 7 +

Mac OS X 10.8 +

120 MB de espaço livre no disco rígido para a instalação

obtenha ajuda em support.steelseries.com

VISÃO GERAL DO PRODUTO

01 Cabo removível*

02 Botões principais do mouse com design de gatilho dividido

03 Roda de rolagem





- 04 Botão CPI / Calibração de altura
- 05 Painéis laterais removíveis com revestimento lateral de borracha*
- 06 Botões laterais
- 07 Pés PTFE
- 08 Sensor de altura dedicado
- 09 Sensor TrueMove3
- 10 Moldes de peso
- 11 Caixa de pesos
- 12 Pesos (8x 3,75g)

* Encontre acessórios e peças de reposição em steelseries.com/gaming-accessories

CONFIGURAÇÃO

Instalação de hardware

Configurando sistema de peso

- 01 Remova os painéis laterais  para acessar os moldes de peso
- 02 Escolha os pesos desejados  e insira-os nos moldes dedicados 
- 03 Encaixe os painéis laterais novamente  quando o peso desejado estiver calibrado. Se achar que não está do seu agrado, repita os passos 01 a 03.

obtenha ajuda em support.steelseries.com

Calibragem do sensor de altura

Seu Rival 600 é equipado com um sensor de altura secundário de alta precisão. Para garantir o nível máximo de precisão, o sensor de altura deve estar calibrado para a superfície de sua escolha.

Por padrão, seu Rival 600 é definido para uma distância de 0,5 mm. O SteelSeries Engine oferece a possibilidade de modificar a distância da altura.

A calibragem do sensor de altura pode ocorrer de duas maneiras:

Automático

Sempre que o mouse é ligado (por exemplo, ao conectar o cabo USB), seu sensor de altura irá calibrar automaticamente.

Manual

Se você mudar de superfície de apoio, recomendamos recalibrar o sensor de altura.

Para calibrar manualmente o sensor de altura, segure o botão CPI por 2 segundos para forçar a recalibragem. Seu Rival 600 irá piscar em branco três vezes quando a calibragem de altura for concluída.

REGULATORY



Europe - EU Declaration of Conformity

Hereby, SteelSeries ApS. declares that the equipment which is compliance with directive RoHS 2.0 (2015/863/EU), R.E.D (2014/53/EU), EMC Directive (2014/30/EU), and LVD (2014/35/EU) which are issued by the Commission of the European Community. The full text of the EU declaration of conformity is available at the following internet address: <https://steelseries.com/>

SteelSeries ApS. hereby confirms, to date, based on the feedback from our suppliers indicates that our products shipping to the EU territory comply with REACH (Registration, Evaluation, Authorization, and Restriction of Chemicals - (EC) 1907/2006) compliance program. We are fully committed to offering REACH compliance on the products and posting accurate REACH compliance status for the all of products.

WEEE

This product must not be disposed of with your other household waste or treat them in compliance with the local regulations or contact your local city office, your household waste disposal service or the shop where you purchased the product.



Türkiye Cumhuriyeti: EEE Yönetmeliğine Uygundur

Ukraine RoHS:

Обладнання відповідає вимогам Технічного регламенту щодо обмеження використання деяких небезпечних речовин в електричному та електронному обладнанні, затвердженого постановою Кабінету Міністрів України від 3 грудня 2008 № 1057

This product is compliant with requirements of Circular No. 30/2011/TT-BCT Regulations "STIPULATING TEMPORARILY THE PERMISSIBLE CONTENT LIMITATION OF SOME TOXIC CHEMICALS IN THE ELECTRONIC, ELECTRICAL PRODUCTS"

Restriction on Hazardous Substances statement (India)

This product complies with the "India E-waste Rule 2011" and prohibits use of lead, mercury, hexavalent chromium, polybrominated biphenyls or polybrominated diphenyl ethers in concentrations exceeding 0.1 weight % and 0.01 weight % for cadmium, except for the exemptions set in Schedule 2 of the Rule.

《废弃电器电子产品回收处理管理条例》提示性说明

为了更好地关爱及保护地球，当用户不再需要此产品或产品寿命终止时，请遵守国家废弃电器电子产品回收处理相关法律法规，将其交给当地具有国家认可的回收处理资质的厂商进行回收处理。



Federal Communication Commission Interference Statement

This device complies with Part 15 of the FCC Rules. Operation is subject to the following two conditions: (1) This device may not cause harmful interference, and (2) this device must accept any interference received, including interference that may cause undesired operation.

This equipment has been tested and found to comply with the limits for a Class B digital device, pursuant to Part 15 of the FCC Rules. These limits are designed to provide reasonable protection against harmful interference in a residential installation. This equipment generates, uses and can radiate radio frequency energy and, if not installed and used in accordance with the instructions, may cause harmful interference to radio communications. However, there is no guarantee that interference will not occur in a particular installation. If this equipment does cause harmful interference to radio or television reception, which can be determined by turning the equipment off and on, the user is encouraged to try to correct the interference by one of the following measures:

- Reorient or relocate the receiving antenna.
- Increase the separation between the equipment and receiver.
- Connect the equipment into an outlet on a circuit different from that to which the receiver is connected.
- Consult the dealer or an experienced radio/TV technician for help.

FCC Caution: Any changes or modifications not expressly approved by the party responsible for compliance could void the user's authority to operate this equipment.

This Class B digital apparatus complies with Canadian ICES-003.
Cet appareil numérique de la classe B est conforme à la norme NMB-003 du Canada.

이 기기는 가정용(B급) 전자파적합기기로서 주로 가정에서 사용하는 것을 목적으로 하며, 모든 지역에서 사용할 수 있습니다



この装置は、情報処理装置等電波障害自主規制協議会(VCCI)の基準に基づくクラスB情報技術装置です。この装置、家庭環境で使用することを目的としていますが、この装置がラジオやテレビジョン受信機に近接して使用されると、受信障害を引き起こすことがあります。取扱説明書に従って正しい取り扱いをしてください。

The RoHS test method is based on the standards JIS C 0950 and CNS 15663

設備名稱: Equipment name	滑鼠/Mouse	型號(型式): Type designation		M-00009		
單元 Unit	限用物質及其化學符號 Restricted substances and its chemical symbols					
	鉛 Lead (Pb)	汞 Mercury (Hg)	鎘 Cadmium (Cd)	六價鉻 Hexavalent chromium (Cr+6)	多溴聯苯 Polybrominated biphenyls (PBB)	多溴二苯醚 Polybrominated diphenyl ethers (PBDE)
塑膠部件/Plastic	○	○	○	○	○	○
電路板及元件/PCBA	—	○	○	○	○	○
線材/Cables	—	○	○	○	○	○
金屬部件/Metal	—	○	○	○	○	○
<p>備考1. "超出0.1 wt %" 及 "超出0.01 wt %" 係指限用物質之百分比含量超出百分比含量基準值。 Note 1: "Exceeding 0.1 wt %" and "exceeding 0.01 wt %" indicate that the percentage content of the restricted substance exceeds the reference percentage value of presence condition.</p> <p>備考2. "○" 係指該項限用物質之百分比含量未超出百分比含量基準值。 Note 2: "○" indicates that the percentage content of the restricted substance does not exceed the percentage of reference value of presence.</p> <p>備考3. "—" 係指該項限用物質為排除項目。 Note 3: The "-" indicates that the restricted substance corresponds to the exemption</p>						

根据中国大陆《电子电气产品有害物质限制使用标识要求》，以下部分列出了产品中可能包含的有害物质的名称和含量：

零部件名称	有害物质					
	铅 (Pb)	汞 (Hg)	镉 (Cd)	六价铬 (Cr(VI))	多溴联苯 (PBB)	多溴二苯醚 (PBDE)
电路板组件	×	○	○	○	○	○
其他线材	×	○	○	○	○	○

*：电路板组件包括印刷电路板及其构成的零部件，如电阻、电容、集成电路、连接器等。

本表格依据SJ/T 11364的规定编制。
 ○：表示该有害物质在该部件所有均质材料中的含量均在 GB/T 26572 规定的限量要求以下。
 ×：表示该有害物质至少在该部件的某一均质材料中的含量超出GB/T 26572规定的限量要求；
 上表中打“X”的部件，应功能需要，部分有害物质含量超出GB/T 26572规定的限量要求，
 但是符合欧盟RoHS法规要求(属于豁免部分)。



该电子电气产品含有某些有害物质，在环保使用期限内可以放心使用，超过环保使用期限之后则应该进入回收循环系统。



ACMA Compliance (Australia/ New-Zealand)



1. 상호명: SteelSeries ApS.
2. 기기명칭: Mouse
3. 모델명: M-00009
4. 인증번호: MSIP-REM-SS4-M-00009
5. 제조사/ 제조국: SteelSeries ApS./China



Custom Union Compliance.
(Russia / Belarus / Kazakhstan)



Direct Current

Regions	Contact information	
Asia 亞洲	16F, No.150, Jian-Yi Rd., Chung-Ho Dist, New Taipei City, Taiwan, R.O.C.(235) 丹麥商賽睿有限公司 新北市中和區建一路150號16樓	+886 2 8226 3858
USA	656 W Randolph St, Suite 3E Chicago, IL 60661, USA	+1 312 258 9467
Europe	Dirch Passers Allé 27, 5.Sal 2000 Frederiksberg, Denmark	+45 702 500 75

More information and support at steelseries.com

Product Name(產品名稱/产品名称): Mouse (滑鼠/鼠标)

Model No. (型號/型号): M-00009

Rated (規格/规格): 5V , 200mA

Made in China 中國製造/中国制造

Operating Temperature: 0 to + 40 °C