

INSPIRE 1

User Manual V1.0

2014.12

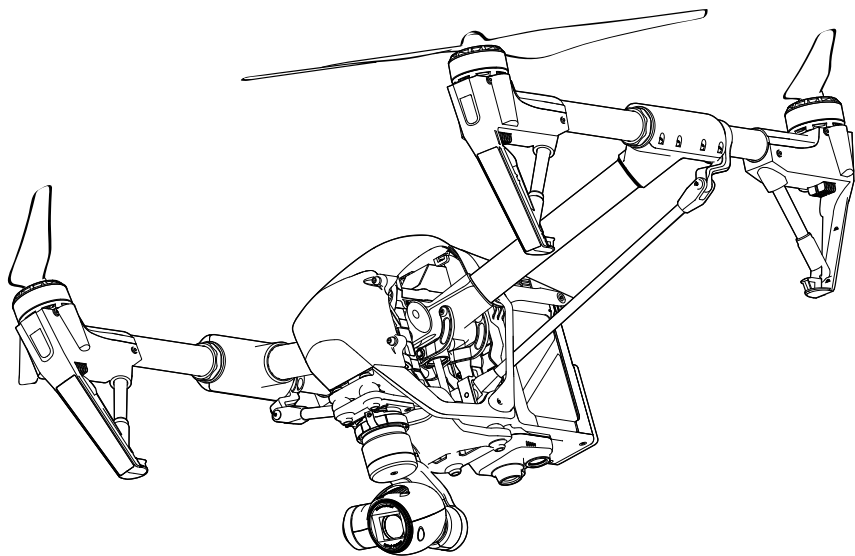

Using this manual

Legends

 Warning

 Important

 Hints and Tips

 Reference

Before Flight

The following tutorials and manuals have been produced to ensure you to make full use of your Inspire 1.

- 1.Disclaimer
- 2.In the Box
- 3.Inspire 1 Quick Start Guide
- 4.Safety Guidelines
- 5.Inspire 1 User Manual
- 6.Intelligent Flight Battery Safety Guidelines

Watching all the tutorial videos and reading the Disclaimer before flight is recommended. Afterwards, prepare for your first flight by using the Inspire 1 Quick Start Guide. Refer to this manual for more comprehensive information.

Watch the video tutorials

Please watch the tutorial video below to learn how to use Inspire 1 correctly and safely:

www.dji.com/product/inspire-1/video



Download the DJI Pilot app

Download and install the DJI Pilot app before use. Scan the QR code or visit "<http://m.dji.net/djipilot>" to download the app.



For the best experience, use mobile device with Android V 4.1.2 or above. Requires iOS 8.0 or later.

Contents

Using this manual

Legends	2
Before Flight	2
Watch the video tutorials	2
Download the DJI Pilot app	2

Product Profile

Introduction	6
Feature Highlights	6
Assemble the Aircraft	7
Aircraft Diagram	9
Remote Controller Diagram	9

Aircraft

Flight Controller	12
Flight Mode	12
Flight Status Indicator	12
Return to Home (RTH)	13
Dynamic Home Point	15
Vision Positioning System	16
Flight Recorder	17
Attaching and Detaching the Propellers	17
DJI Intelligent Flight Battery	18

Remote Controllers

Remote Controller Profile	24
Remote Controller Operations	24
Dual Remote Controllers Mode	29
Remote Controller Status LED	31
Linking the Remote Controller	32
Remote Controller Compliance Version	33

Gimbal and Camera

Camera Profile	35
Gimbal	36

DJI Pilot App

Camera	40
Map	43
Academy	43
User Center	43

Flight

Flight Environment Requirements	45
Flight Limits and Flight Restriction Area	45
Preflight Checklist	49
Calibrating the Compass	49
Auto Take-off and Auto Landing	50
Starting/Stopping the Motors	51
Flight Test	51

FAQ

Appendix

Specifications	57
Intelligent Orientation Control (IOC)	60
How to Update Firmware	61
FCC Compliance	62

Product Profile

This chapter describes the features of Inspire 1, instructs you to assemble the aircraft and explains the components on the aircraft and remote controllers.

Product Profile

Introduction

The Inspire 1 is brand new quadcopter capable of capturing 4K video and transmitting an HD video signal (up to 2km) to multiple devices straight out of the box. Equipped with retractable landing gear, it can capture an unobstructed 360 degree view from its camera. The built-in camera has an integrated gimbal to maximize stability and weight efficiency while minimizing space. When no GPS signal is available, Vision Positioning technology provides hovering precision.

Feature Highlights

Camera and Gimbal: Up to 4K video recording and 12 megapixel photo capture. Reserved mounting space for ND filters for better exposure control. New quick-release mount allows you to remove the camera with ease.

HD Video Downlink: Low latency, HD downlink powered by an enhanced version of the DJI Lightbridge system. It also provides dual controllers mode.

Landing gear: Retractable landing gear that enables an unobstructed panoramic view from the camera.

DJI Intelligent Flight Battery: 4500 mAh DJI Intelligent Flight Battery employs new battery cells and a battery management system.

Flight Controller: The next generation flight controller system provides a more reliable flight experience. A new flight recorder stores the flight data from each flight, and Vision Positioning enhances hovering precision when no GPS is available.

Assemble the Aircraft

Unlocking Travel Mode

The aircraft is in Travel Mode during delivery. Follow these steps to change it to Landing Mode before your first flight:

1. Insert the Intelligent Flight Battery into the battery compartment.
2. Power on the Remote Controller and the Intelligent Flight Battery.
3. Toggle the Transformation Switch up and down at least four times.
4. Power off the aircraft.

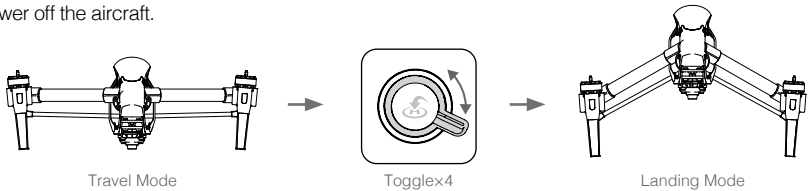

- ⚠**
- Battery must be fully charged before using it for the first time. Refer to "Charging the Intelligent Flight Battery" (P21) for more information .
 - If you have purchased the dual remote controller version, you must use the Master remote controller to deactivate Travel Mode. Refer to "Setting Up Dual Remote Controllers Mode" (P30) section for more information about Master remote controller.
 - Be sure to remove the gimbal from the aircraft before switch from Landing Mode to Travel Mode.
 - Place the aircraft on the smooth and reflective surface (e.g. table or tile) before switching between the travel modes to the landing mode. Do not place the aircraft on the rough and sound-absorbing surface (e.g. carpet) before switching between the travel modes and landing mode.

Installing Gimbal and Camera

1. Remove Gimbal Cover.
2. Rotate the Gimbal Lock to the unlocked position (to the right when facing the nose of the aircraft).
3. Insert the gimbal by aligning the white mark on the Gimbal.
4. Rotate the Gimbal Lock back into the locked position.

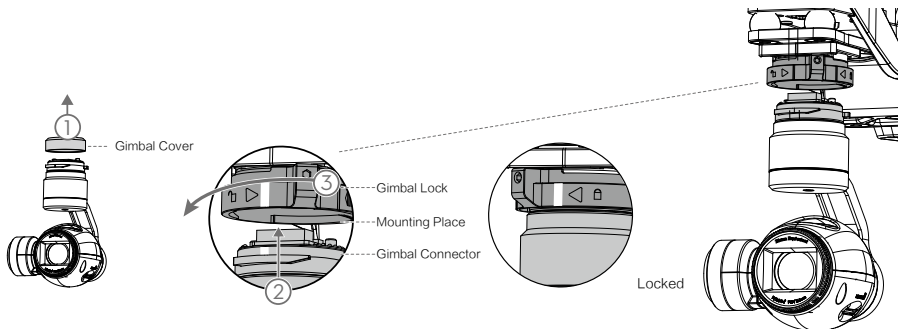

- ⚠** Ensure the Micro-SD card is correctly inserted into the camera.

Attaching Propellers

Attach propellers with the black nut onto motors with the black dot and spin counter-clockwise to secure. Attach propellers with gray nut onto motors without a black dot and spin clockwise to secure.

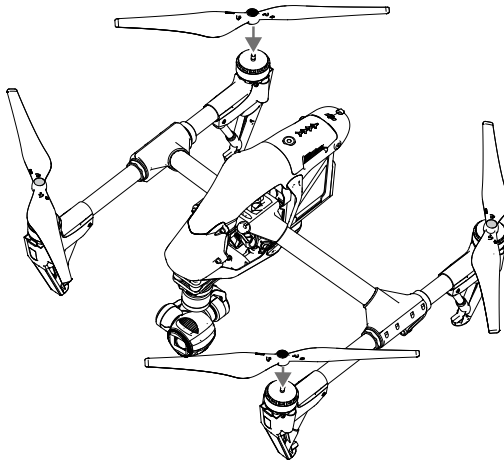

 Place all propellers onto the correct motor and tighten by hand to ensure security before flight.

Preparing Remote Controller

Tilt the Mobile Device Holder to the desired position then adjust the antenna as shown.

1. Press the button on the side of the Mobile Device Holder to release the clamp, adjust it to fit then attach your mobile device.
2. Connect your mobile device to the remote controller with a USB cable.
3. Plug one end of the cable into your mobile device, and the other end into the USB port on the back of the remote controller.

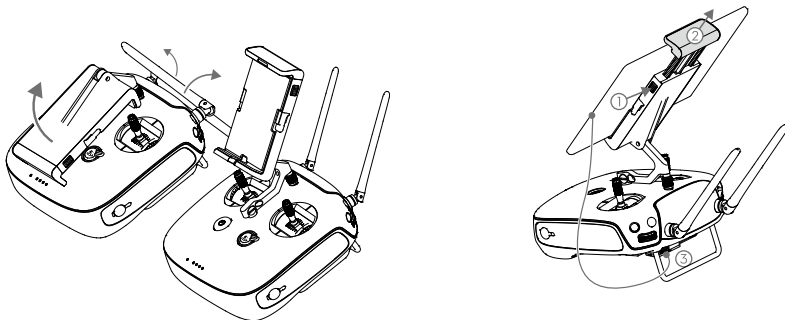

Aircraft Diagram

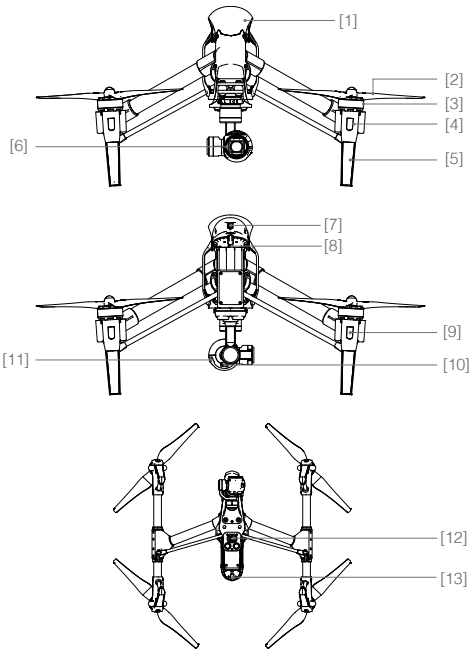

- [1] GPS
- [2] Propeller (P17)
- [3] Motor
- [4] Front LED (P12)
- [5] Landing gear
- [6] Gimbal and Camera (P37)
- [7] Intelligent Flight Battery (P18)
- [8] Aircraft Micro-USB Port
- [9] Rear LED (P12)
- [10] Camera Micro-USB Port
- [11] Camera Micro-SD Card Slot (P35)
- [12] Vision Positioning Sensors (P16)
- [13] Aircraft Status Indicator (P13)

Remote Controller Diagram

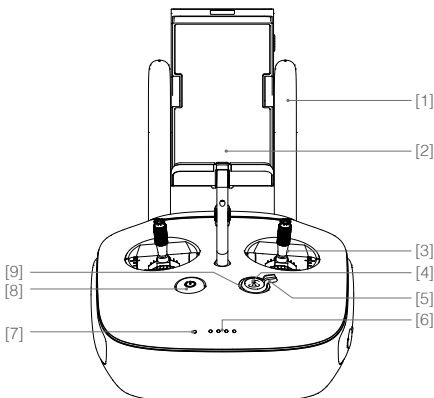

- [1] Antennas (P29)
Relays aircraft control and video signal.
- [2] Mobile Device Holder
Mounting place for your mobile device.
- [3] Control Stick
Controls aircraft orientation.
- [4] Return Home (RTH) Button (P13)
Press and hold the button to initiate Return to Home (RTH).
- [5] Transformation Switch (P27)
Toggle the switch up or down to raise or lower the landing gear.

[6] Battery Level LEDs

Displays the current battery level.

[7] Status LED

Displays the power status.

[8] Power Button

Used to power on or power off the remote controller.

[9] RTH LED

Circular LED around the RTH button displays RTH status.

[10] Camera Settings Dial

Turn the dial to adjust camera settings. Only functions when the remote controller is connected to a mobile device running the DJI Pilot app.

[11] Playback Button

Playback the captured images or videos.

[12] Shutter Button

Press to take a photo. If in burst mode, the set number of photos will be taken with one press.

[13] Flight Mode Switch

Used to switch between P, A and F mode.

[14] Video Recording Button

Press to start recording video. Press again to stop recording.

[15] Gimbal Dial

Use this dial to control the tilt of the gimbal.

[16] Micro-USB Port

For connecting the remote controller to your computer.

[17] Mini-HDMI Port

Connect an HD compatible monitor to this port to get a live HD video preview of what the camera sees.

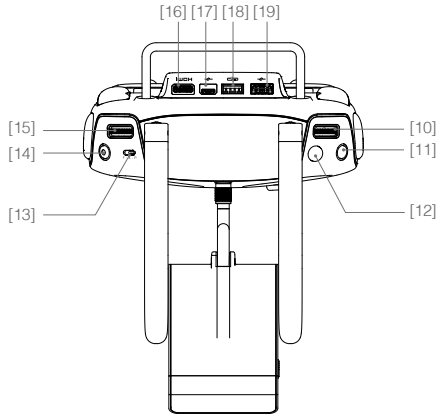

[18] CAN Bus Port

Reserved for future use.

[19] USB Port

Connect to mobile device to access all of the DJI Pilot app controls and features.

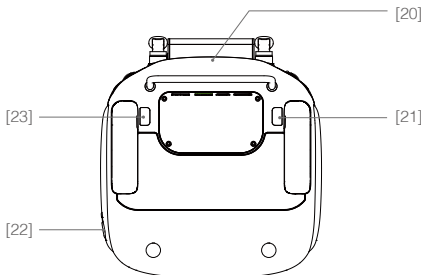

[20] GPS Module

Used to pinpoint the location of the remote controller.

[21] Back Left Button

Customizable button in DJI Pilot app.

[22] Power Port

Connect to a power source to charge the remote controller's internal battery.

[23] Back Right Button

Customizable button in DJI Pilot app.

Aircraft

This chapter describes the features of the Flight Controller, Vision Positioning System and the Intelligent Flight Battery.

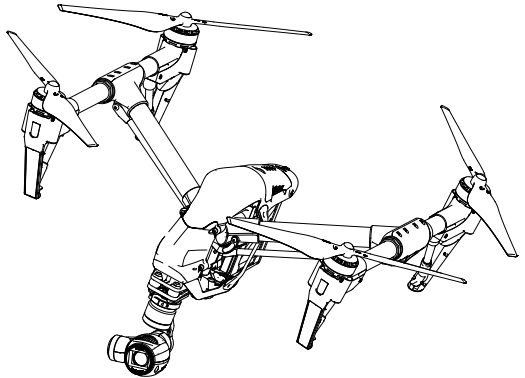

Aircraft

Flight Controller

The Inspire 1's flight controller is based on DJI flight controller with several enhancements such as new flight mode and new safe mode. Three safe modes are available: Failsafe, Return Home and Dynamic Home Point. These features ensure the safe return of your aircraft if the control signal is lost. A flight recorder stores crucial flight data for each flight.

Flight Mode

Three flight modes are available. The details of each flight mode are found in the section below:

P mode (Positioning) : P mode works best when GPS signal is strong. There are three different states of P mode, which will be automatically selected by the Inspire 1 depending on GPS signal strength and Vision Positioning sensors:

P-GPS: GPS and Vision Positioning both are available, and the aircraft is using GPS for positioning.

P-OPTI: Vision Positioning is available but the GPS signal is not. Aircraft is using only Vision Positioning for hovering

P-ATTI: Neither GPS or Vision Positioning available, aircraft is using only its barometer for positioning, so only altitude is controlled.

A mode (Attitude): The GPS and Vision Positioning System is not used for holding position. The aircraft only uses its barometer to maintain altitude. If it is still receiving a GPS signal, the aircraft can automatically return home if the Remote Controller signal is lost and if the Home Point has been recorded successfully.

F mode (Function): Intelligent Orientation Control (IOC) is activated in this mode. For more information about IOC, refer to the IOC in Appendix.



Use the Flight Controller mode switch to change the flight mode of the aircraft, refer to the "Flight Mode Switch" on P27 for more information.

Flight Status Indicator

The INSPIRE 1 comes with the Front LED, Rear LED and Aircraft Status Indicator. The positions of these LEDs are shown in the figure below:

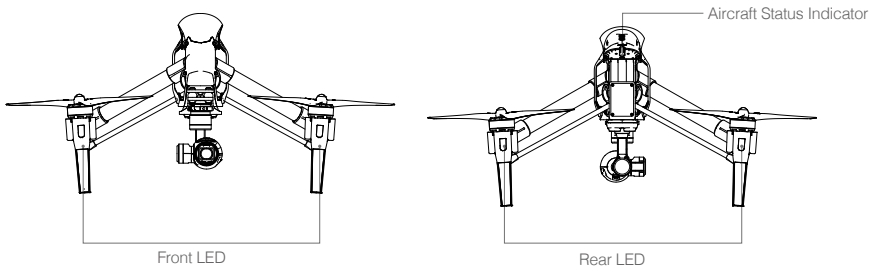





The Front and Rear LED show the orientation of the aircraft. The Front LED displays solid red and the Rear LED displays solid green.







Aircraft Status Indicator shows the system status of the flight controller. Refer to the table below for more information about the Aircraft Status Indicator:

Aircraft Status Indicator Description

Normal



 Red, Green and Yellow Flash Alternately	Power on and self-check
 Green and Yellow Flash Alternately	Aircraft warming up
 Green Flashes Slowly	Safe to Fly (P mode with GPS and Vision Positioning)
 X2 Green Flashes Twice	Safe to Fly (P mode with Vision Positioning but without GPS)
 Yellow Flashes Slowly	Safe to Fly (A mode but No GPS and Vision Positioning)

Warning

 Fast Yellow Flashing	Remote Controller Signal Lost
 Slow Red Flashing	Low Battery Warning
 Fast Red Flashing	Critical Low Battery Warning
 Red Flashing Alternately	IMU Error
 — Solid Red	Critical Error
 Red and Yellow Flash Alternately	Compass Calibration Required

Return to Home (RTH)

The Return to Home (RTH) brings the aircraft back to the last recorded Home Point. There are three cases that will trigger RTH procedure; they are Smart RTH, Low Battery RTH and Failsafe RTH.

	GPS	Description
Home Point		The Home Point is the location at which your aircraft takes off when the GPS signal is strong. You can view the GPS signal strength through the GPS icon (). If you are using the Dynamic Home Point setting, the Home Point will be updated to your current position as you move around and when the Aircraft Status Indicator blinks green.

Smart RTH

Using the RTH button on the remote controller (refer to “RTH button” on P28 for more information) or the RTH button in the DJI Pilot app when GPS is available to enables smart RTH. The aircraft return to the latest recorded Home Point, you may control the aircraft's orientation to avoid collision during the Smart RTH. Press the Smart RTH button once to start the process, press the Smart RTH button again to exit Smart RTH and regain the control.

Low Battery RTH

The low battery level failsafe is triggered when the DJI Intelligent Flight Battery is depleted to a point that may affect the safe return of the aircraft. Users are advised to return home or land the aircraft immediately when these warnings are shown. DJI Pilot app will advise user to return the aircraft to the Home Point when low battery warning is triggered. Aircraft will automatically return to the Home Point if no action is taken after 10 seconds countdown. User can cancel the RTH by pressing once on the RTH button. The thresholds for these warnings are automatically determined based on the current aircraft altitude and its distance from the Home Point.

Aircraft will land automatically if the current battery level can only support the aircraft to land to the ground from the current altitude. User can use the remote controller to control the aircraft's orientation during the landing process.

The Battery Level Indicator is displayed in the DJI Pilot app, and is described below

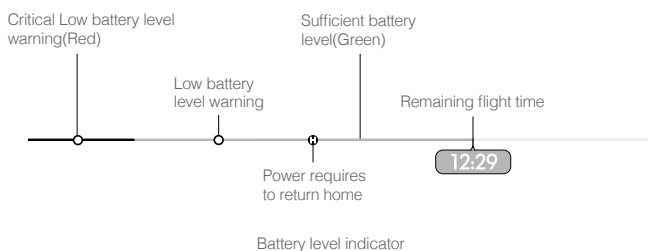

Battery Level Warning	Remark	Aircraft Status Indicator	DJI Pilot app	Flight Instructions
Low battery level warning	The battery power is low. Please land the aircraft.	Aircraft status indicator blinks RED slowly.	Tap "Go-home" to have the aircraft return to the Home point and land automatically, or "Cancel" to resume normal flight. If no action is taken, the aircraft will automatically go home and land after 10 seconds. Remote controller will sound an alarm.	Fly the aircraft back and land it as soon as possible, then stop the motors and replace the battery.
Critical Low battery level warning	The aircraft must land immediately.	Aircraft status indicator blinks RED quickly.	The DJI Pilot app screen will flash red and aircraft starts to descend. Remote controller will sound an alarm.	The aircraft will begin to descend and land automatically.
Estimated remaining flight time	Estimated remaining flight based on current battery level.	N/A	N/A	N/A

- ☀️ • When the critical battery level warning activates and the aircraft is descending to land automatically, you may push the throttle upward to hover the aircraft and navigate it to a more appropriate location for landing.
- Color zones and markers on the battery level indicator reflect estimated remaining flight time and are adjusted automatically, according to the aircraft's current status.

Failsafe RTH

Failsafe RTH is activated automatically if remote controller signal (including video relay signal) is lost for more than 3 seconds provided that Home Point has been successfully recorded and compass is working normally. Return home process may be interrupted and the operator can regain control over the aircraft if a remote controller signal is resumed.

Failsafe Illustration

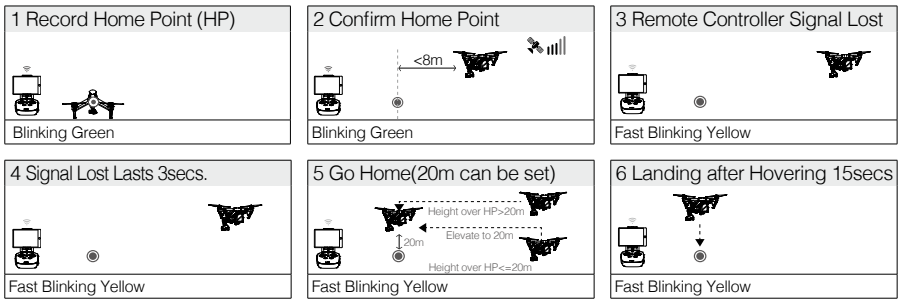

- ⚠️ • Aircraft cannot avoid obstruction during the Failsafe RTH, therefore it is important to set a reasonable Failsafe altitude before each flight. Launch the DJI Pilot app and enter "Camera" view and select "MODE" to set the Failsafe altitude.
- Aircraft will stop ascending and immediately return to the Home Point if you move the throttle stick during the Failsafe.

Dynamic Home Point

Dynamic home point is useful in situations when you are in motion and require a Home Point that is different from the takeoff point. GPS module is located at the position shown in the figure below:

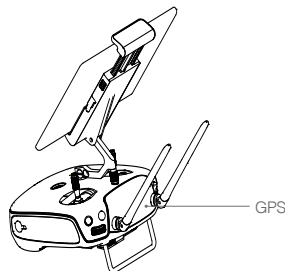

- ⚠️ Ensure the space above the GPS module is not obstructed when using Dynamic Home Point.

There are two options for Dynamic Home Point.

1. Set the aircraft current coordinate as the new Home Point.
2. Set the remote controller's coordinate as the new Home Point.

Setting Up Dynamic Home Point

Follow the steps below to setup Dynamic Home Point:

1. Connect to the mobile device and launch the DJI Pilot app and go to the "Camera" page.
2. Tap "📍" and select "🏠", to reset the remote controller's coordinates as the new Home Point.
3. Tap "📍" and select "🚁", to reset the aircraft's coordinates as the new Home Point.
4. The aircraft status indicator blinks green to show Home Point is set successfully.

Aircraft

Vision Positioning System

DJI Vision Positioning is a positioning system that uses ultrasonic and image data to help the aircraft identify its current position. With the help of Vision Positioning, your Inspire 1 can hover in place more precisely and fly indoors or in other environments where there is no GPS signal available. The main components of DJI Vision Positioning are located on the bottom of your Inspire 1, including [1]two sonar sensors and [2]one monocular camera.

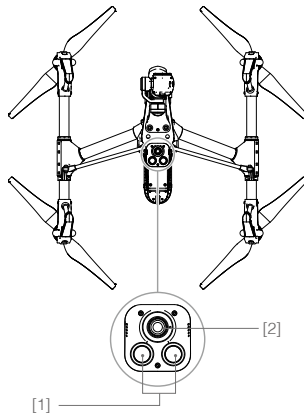

Using Vision Positioning

Vision Positioning is activated automatically when the Inspire 1 is powered on. No manual action is required. Vision Positioning is typically used in the indoor environment where no GPS is available. By using the sensors on the Vision Positioning system, Inspire 1 can perform precision hovering even when no GPS is available.

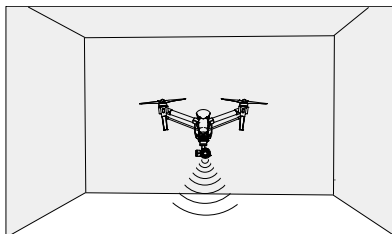

Follow the steps below to use Vision Positioning:

1. Toggle the switch to "P" as shown the figure to the right:
2. Place the Inspire 1 on a flat surface. Notice that the Vision Positioning system cannot work properly on surfaces without pattern variations.
3. Power on the Inspire 1. The aircraft status indicator will flash twice in green light, which indicates the Vision Positioning system is ready. Gently push the throttle up to lift off, and the Inspire 1 will hover in place.

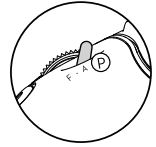

⚠ The performance of your Inspire 1's Vision Positioning System is subject to the surface you are flying over. The ultrasonic waves may not be able to accurately measure the distance over sound absorbing materials, and the camera may not function correctly in suboptimal environments. The aircraft will switch from "P" mode to "A" mode automatically if both GPS and Vision Positioning System are not available. So operate the aircraft cautiously when in any of the following situations:

- Flying over monochrome surfaces (e.g. pure black, pure white, pure red, pure green).
- Flying over a highly reflective surfaces.
- Flying at high speeds(over 8m/s at 2 meters or over 4m/s at 1 meter).
- Flying over water or transparent surfaces.
- Flying over moving surfaces or objects.
- Flying in an area where the lighting changes frequently or drastically.
- Flying over extremely dark (lux < 10) or bright (lux > 10,000) surfaces.
- Flying over surfaces that can absorb sound waves (e.g. thick carpet).
- Flying over surfaces without clear patterns or texture.
- Flying over surfaces with identical repeating patterns or textures (e.g. tiles with same design).
- Flying over inclined surfaces that will deflect sound waves away from the aircraft.
- In the event of loss of remote controller's signal, the aircraft will hover for 8 seconds and then auto-land if it is in "P" mode.

- ☀**
- Keep the sensors clean at all times. Dirt or other debris may adversely affect the effectiveness of the sensors.
 - The effective hovering altitudes of the aircraft is from 0 to 2.5 meters.
 - Vision Positioning system may not function properly when the aircraft is flying over water.
 - Vision Positioning system may not be able to recognize pattern on the ground in low light conditions (less than 100lux).
 - Do not use other ultrasonic devices with frequency of 40 KHz when Vision Positioning system is in operation.
 - Vision Positioning system may not be able to stabilize the aircraft when flying close to the ground (below 0.5 meters) in fast speed.





- ⊙** Keep the animals away from the aircraft when Vision Positioning system is activated. The sonar sensor emits high frequency sound that is only audible to some animals.

Flight Recorder

Flight data is automatically recorded to the SD card. This includes flight duration, orientation, distance, aircraft status information, speed, and other parameters.

Attaching and Detaching the Propellers

Use only DJI approved propellers with your Inspire 1. The grey or black nut on the propeller indicates the rotation direction of the propeller and where it should be attached. To attach the propellers properly, match the nut with the dots on the motors of your Inspire 1:

Propellers	Grey cap(1345)	Black cap(1345R)
Figure		
Attach On	Motors without a black dot	Motors with a black dot
Legends	 Lock : Turn the propellers in the indicated direction to mount and tighten  Unlock : Turn the propellers in the indicated direction to loosen and remove	

Attaching the Propellers

1. Attach the propellers with a grey nut onto a motor without a black dot and spin the propellers clockwise to secure them in place. Attach the propellers with a black nut onto a motor with a black dot and spin the propellers counter clockwise to secure its position. Be sure to completely tighten each propeller by hand before flight.

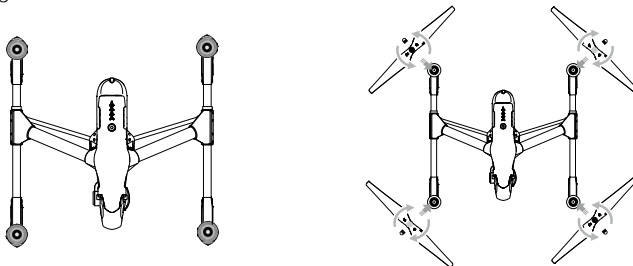

- ⚠ Ensure propellers are attached to its corresponding motors, otherwise the aircraft cannot take off.
- Handling the propellers with care.
- Manually tightent each of the propellers on the corresponding motors to ensure it is attached firmly.

Detaching the Propellers

Hold the motor still. Then spin the propeller in the unlock direction indicated on the propeller itself.

- ⚠ • Check that the propellers and motors are installed correctly and firmly before every flight.
- Ensure that all propellers are in good condition before each flight. DO NOT use old, chipped, or broken propellers.
- To avoid injury, STAND CLEAR of and DO NOT touch propellers or motors when they are spinning.
- ONLY use original DJI propellers for a better and safer flight experience.

DJI Intelligent Flight Battery

The DJI Intelligent Flight Battery has a capacity of 4500mAh, voltage of 22.2V, and smart charge-discharge functionality. It can only be charged with an appropriate DJI approved charger.

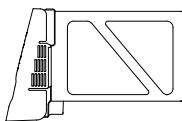

Intelligent Flight Battery

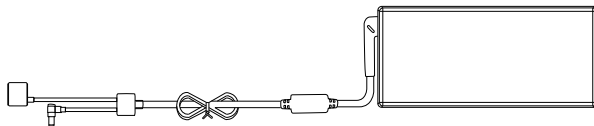

Charger

-
- ⚠ Battery must be fully charged before using it for the first time. Refer to "Charging the Intelligent Flight Battery" P21 for more information .
-

DJI Intelligent Flight Battery Functions

1. Battery Level Display: LEDs display the current battery level.
2. Battery Life Display: LEDs display the current battery power cycle.
3. Auto-discharging Function: The battery automatically discharges to below 65% of total power when it is idle (press the power button to check battery level will cause battery to exit idle state) for more than 10 days to prevent swelling. It takes around 2 days to discharge the battery to 65%. It is normal to feel moderate heat emitting from the battery during the discharge process. Discharge thresholds can be set in the DJI Pilot app.
4. Balanced Charging: Automatically balances the voltage of each battery cell when charging.
5. Over charge Protection: Charging automatically stops when the battery is fully charged.
6. Temperature Detection: The battery will only charge when the temperature is between 0 °C(32°F) and 40°C (104°F).
7. Over Current Protection: Battery stops charging when high amperage (more than 10A) is detected.
8. Over Discharge Protection: Discharging automatically stops when the battery voltage reaches 18V to prevent over-discharge damage
9. Short Circuit Protection: Automatically cuts the power supply when a short circuit is detected.
10. Battery Cell Damages Protection: DJI Pilot app shows warning message when damaged battery cell is detected.
11. Battery Information History: Show the last 32 entries of battery information records that include warning messages and so on.
12. Sleep Mode: Sleep mode is entered after 10 minutes of inactivity to save power.
13. Communication: Battery voltage, capacity, current, and other relevant information is provided to the aircraft's to the main controller.

-
- ⚠ Refer to *Disclaimer* and *Intelligent Flight Battery Safety Guidelines* before use. Users take full responsibility for all operations and usage.
-

Using the Battery

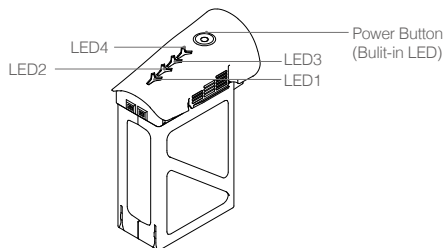

Powering ON/OFF

Powering On: Press the Power Button once, then press again and hold for 2 seconds to power on. The Power LED will turn red and the Battery Level Indicators will display the current battery level.

Powering Off: Press the Power Button once, then press again and hold for 2 seconds to power off.

Low Temperature Notice:



1. The performance of the intelligent Flight Battery is significantly reduced when flying in a low temperature environments (those with air temperatures below 5°C). Ensure that the battery is fully charged and the cell voltage is at 4.43 V before each flight.
2. Using the Intelligent Flight Battery in extremely low temperature environments (those with air temperatures below -10°C) is not recommended. When flying in environments with temperatures between 5°C and -10°C, the Intelligent Flight Battery should be able to achieve the appropriate voltage levels (above 4.2 V), but it is recommended that you apply the included insulation sticker to the battery in order to prevent a rapid drop in temperatures.
3. If the DJI Pilot app displays the “Critical Low Battery Level Warning” when flying in low temperature environments, stop flying and land the aircraft immediately. You will still be able to control the aircraft’s movement when this warning is triggered.
4. Store the Intelligent Flight Battery in a room temperature environment and ensure that its temperature exceeds 5°C before using it in the low temperature environment.
5. When using the Inspire 1 in a low temperature environment, begin by allowing the aircraft to hover at a low altitude, for approximately one minute, to heat the battery.
6. To ensure optimum performance, keep the Intelligent Flight Battery’s core temperature above 20°C when in use.





































 In cold environments, insert the battery into the battery compartment and allow the aircraft to warm up for approximately 1-2 minutes before taking off.

Checking the battery level

The Battery Level Indicators display how much remaining power the battery has. When the battery is powered off, press the Power Button once. The Battery Level Indicators will light up to display the current battery level. See below for details.

 The Battery Level Indicators will also show the current battery level during charging and discharging. The indicators are defined below.

-  : LED is on.
-  : LED is flashing.
-  : LED is off.

Battery Level				
LED1	LED2	LED3	LED4	Battery Level
				87.5%~100%
				75%~87.5%
				62.5%~75%
				50%~62.5%
				37.5%~50%
				25%~37.5%
				12.5%~25%
				0%~12.5%
				=0%

Battery life

The battery life indicates how many more times the battery can be discharged and recharged before it must be replaced. When the battery is powered off, press and hold the Power Button for 5 seconds to check the battery life. The Battery Level Indicators will light up and/or blink as described below for 2 seconds:

Battery Life				
LED1	LED2	LED3	LED4	Battery Life
☞	☞	☞	☞	90%~100%
☞	☞	☞	☞ [*]	80%~90%
☞	☞	☞	☞	70%~80%
☞	☞	☞ [*]	☞	60%~70%
☞	☞	☞	☞	50%~60%
☞	☞ [*]	☞	☞	40%~50%
☞	☞	☞	☞	30%~40%
☞ [*]	☞	☞	☞	20%~30%
☞	☞	☞	☞	below 20%

⚠ When battery life reaches 0%, it can no longer be used.

📖 For more information about the battery, launch DJI Pilot app and check the information under the battery tab.

Charging the Intelligent Flight Battery

1. Connect Battery Charger to a power source (100-240V 50/60Hz).
2. Open the Protection Cap and connect the Intelligent Flight Battery to the Battery Charger. If the battery level is above 95%, turn on the battery before charging.
3. The Battery Level Indicator will display the current battery level during charging.
4. The Intelligent Flight Battery is fully charged when Battery Level Indicators are all off.
5. Air cool the Intelligent Flight Battery after each flight. Allow its temperature to drop to room temperature before storing it for an extended period.

- ⚠
- Do not charge the Intelligent Flight Battery and remote controller with standard charger (model: A14-100P1A) at the same time, otherwise the charger may overheat.
 - Always turn off the battery before inserting it or removing it from the Inspire 1. Never insert or remove a battery when it is powered on.

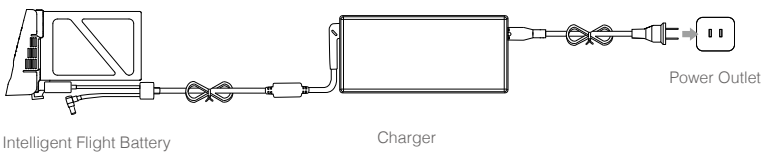

Battery Level Indicators while Charging				
LED1	LED2	LED3	LED4	Battery Level
				0%~25%
				25%~50%
				50%~75%
				75%~100%
				Fully Charged

Charging Protection LED Display

The table below shows battery protection mechanisms and corresponding LED patterns.

Battery Level Indicators while Charging					
LED1	LED2	LED3	LED4	Blinking Pattern	Battery Protection Item
				LED2 blinks twice per second	Over current detected
				LED2 blinks three times per second	Short circuit detected
				LED3 blinks twice per second	Over charge detected
				LED3 blinks three times per second	Over-voltage charger detected
				LED4 blinks twice per second	Charging temperature is too low (<0°C)
				LED4 blinks three times per second	Charging temperature is too high (>40°C)

After any of the above mentioned protection issues are resolved, press the button to turn off the Battery Level Indicator. Unplug the Intelligent Flight Battery from the charger and plug it back in to resume charging. Note that you do not need to unplug and plug the charger in the event of a room temperature error, the charger will resume charging when the temperature falls within the normal range.

DJI does not take any responsibility for damage caused by third-party chargers.

How to discharge your Intelligent Flight Battery:

To effectively calibrate the battery capacity, it is recommended to charge and discharge the battery thoroughly for every 10 charge-and-discharge cycle. User should install the battery onto the aircraft and then power on the aircraft to initiate the discharge process, discharge the battery until the aircraft is powered off automatically. User should then fully charge the battery to ensure the battery is working at its optimal.

Slow: Place the Intelligent Flight Battery into the Inspire 1's Battery Compartment and power it on. Leave it on until there is less than 5% of power left, or until the battery can no longer be turned on. Launch the DJI Pilot app to check battery level.

Rapid: Fly the Inspire 1 outdoors until there is less than 5% of power left, or until the battery can no longer be turned on.

Remote Controllers

This chapter describes the features of the remote controller that includes aircraft and remote controller operations and dual remote controller mode.

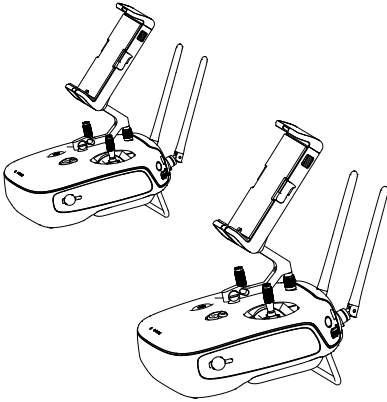

Remote Controller

Remote Controller Profile

The Inspire 1 Remote Controller is a multi-function wireless communication device that integrates the video downlink ground system and aircraft Remote Controller system. The video downlink and aircraft Remote Controller system operate at 2.4 GHz with maximum transmission distance of 2km. The remote controller features a number of camera functions, such as taking and previewing photos and video, and controlling gimbal motions. The remote controller is powered by a 2S rechargeable battery. The current battery level is displayed by LEDs on the front panel of the remote control.



- **Compliance Version:** The Remote Controller is compliant with both CE and FCC regulations.
- **Operating Mode:** Control can be set to Mode 1 , Mode 2.
- **Mode 1:** The right stick serves as the throttle.
- **Mode 2:** The left stick serves as the throttle.



Do not operate more than 3 aircrafts within in the same area (size equivalent to a soccer field) to prevent transmission interference.

Remote Controller Operations

Powering On And Off The Remote Controller

The Inspire 1 remote controller is powered by a 2S rechargeable battery with a capacity of 6000mAh. The battery level is indicated by the Battery Level LEDs on the front panel. Follow the steps below to power on your remote controller:

1. When powered off, press the Power Button once and the Battery Level LEDs will display the current battery level.
2. Then, press and hold the Power Button to power on the remote controller.
3. The Remote Controller will beep when it powers on. The Status LED will blink green (slave remote controller blinks solid purple) rapidly, indicating that the remote controller is linking to the aircraft. The Status LED will show a solid green light when linking is completed.
4. Repeat step 2 to power off the remote controller after finish using it.

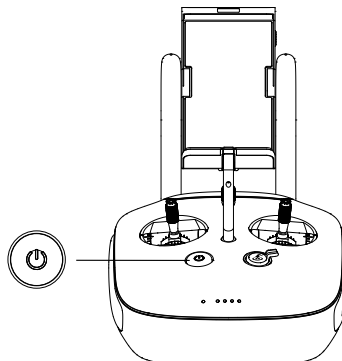

Charging Remote Controller

Charge the remote controller via supplied charger.

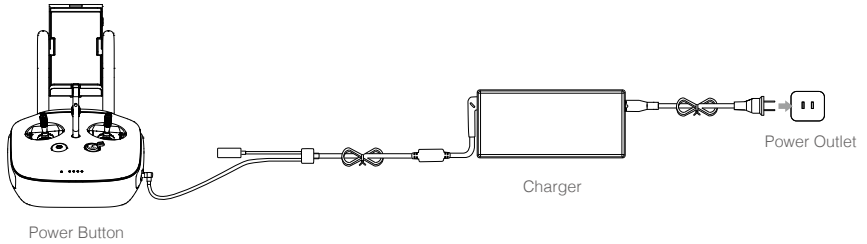

Controlling Camera

Shoot videos or images and adjust camera settings via the Shutter Button, Camera Settings Dial, Playback Button and Video Recording Button on the remote control.

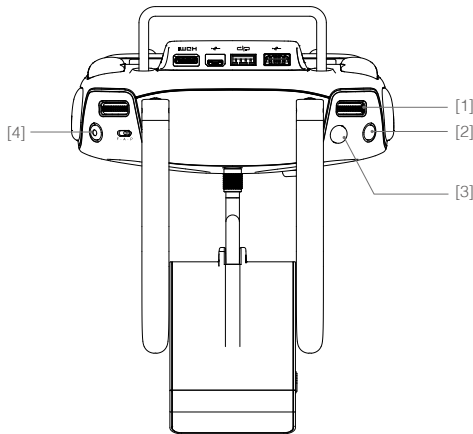

[1] Camera Settings Dial

Turn the dial to quickly adjust camera settings such as ISO and shutter speed without letting go of the remote controller. Move the dial button to left or right to view the pictures or videos in playback mode.

[2] Playback Button

Press to view images or videos that have already been captured.

[3] Shutter Button

Press to take a photo. If burst mode is activated, multiple photos will be taken with a single press.





[4] Recording Button

Press once to start recording video, then press again to stop recording.

Controlling Aircraft

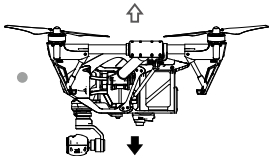

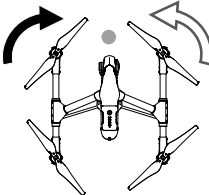
This section explains how to use the various features of the remote controller. The Remote Controller is set to Mode 2 by default.

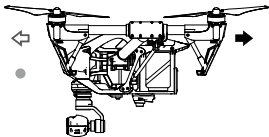
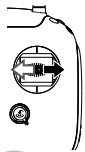
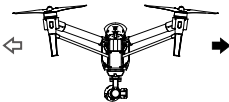
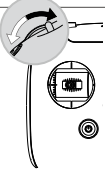
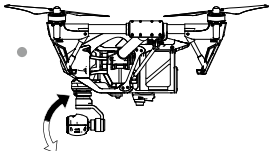
-  Stick Neutral/ mid point: Control sticks of the Remote Controller are placed at the central position.
 Move the Stick: The control stick is pushed away from the central position.

Remote Controller (Mode 2)	Aircraft (● indicates nose direction)	Remarks
		<p>Moving the left stick up and down changes the aircraft's elevation. Push the stick up to ascend and down to descend. Push the throttle stick up to takeoff. When both sticks are centered, the Inspire 1 will hover in place. The more the stick is pushed away from the center position, the faster the Inspire 1 will change elevation. Always push the stick gently to prevent sudden and unexpected elevation changes.</p>
		<p>Moving the left stick to the left or right controls the rudder and rotation of the aircraft. Push the stick left to rotate the aircraft counter clock-wise, and push the stick right to rotate the aircraft clockwise. If the stick is centered, the Inspire 1 will stay facing its current direction. The more the stick is pushed away from the center position, the faster the Inspire 1 will rotate.</p>
		<p>Moving the right stick up and down changes the aircraft's forward and backward pitch. Push the stick up to fly forward and down to fly backward. The Inspire 1 will hover in place if the stick is centered. Push the stick further away from the center position for a larger pitch angle (maximum 35°) and faster flight.</p>
		<p>Moving the right stick control left and right changes the aircraft's left and right pitch. Push left to fly left and right to fly right. The Inspire 1 will hover in place if the stick is centered. Push the stick further away from the center position for a larger pitch angle (maximum 35°) and faster flight.</p>
		<p>Gimbal Dial: Turn the dial to the right, and the camera will shift to point upwards. Turn the dial to the left, and the camera will shift to point downwards. The camera will remain in its current position when dial is static.</p>

Flight Mode Switch

Toggle the switch to select the desired flight mode. You may choose between; P mode, F mode and A mode.

Figure	Flight Mode
F 	F mode
A 	A mode
P 	P mode

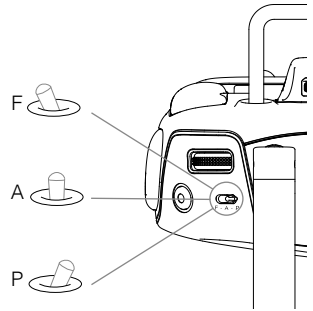

P mode (Positioning) : P mode works best when GPS signal is strong. There are three different states of P mode, which will be automatically selected by the Inspire 1 depending on GPS signal strength and Vision Positioning sensors:

P-GPS: GPS and Vision Positioning both are available, and the aircraft is using GPS for positioning.

P-OPTI: Vision Positioning is available but the GPS signal is not. Aircraft is using only Vision Positioning for hovering

P-ATTI: Neither GPS or Vision Positioning available, aircraft is using only its barometer for positioning, so only altitude is controlled.

A mode (Attitude): The GPS and Vision Positioning System is not used for holding position. The aircraft only uses its barometer to maintain altitude. If it is still receiving a GPS signal, the aircraft can automatically return home if the Remote Controller signal is lost and if the Home Point has been recorded successfully.

F mode (Function): Intelligent Orientation Control (IOC) is activated in this mode. For more information about IOC, refer to the IOC in Appendix.

The Flight Mode Switch is locked in P mode by default. To unlock the switch, launch the DJI Pilot app, enter the "Camera" page, tap "MODE", and then activate "Multiple Flight Mode" .

Transformation Switch / RTH Button

The Transformation Switch / RTH Button combination serves two functions. Toggle the switch up or down to raise or lower the landing gear. Or, press the button to activate the Return to Home (RTH) procedure.

Transformation Switch

This switch has two positions. The effect of toggling the switch to any of these positions is defined below:

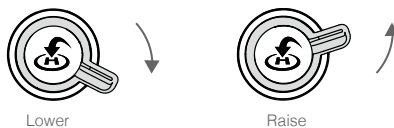

1. **Raise**: Raise the landing gear to its upper most position.

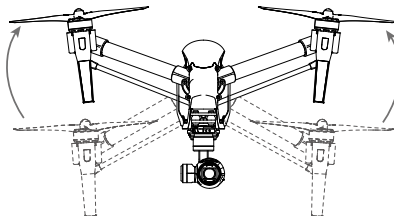

2. **Lower:** The landing gear will lower to its lowest position for landing.

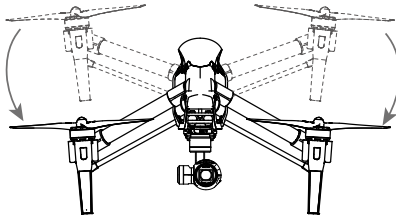

 Do not raise the landing gear when the aircraft is on the ground. Ensure the landing gear is lowered before landing.

RTH button

Press and hold this button to start the Return to Home (RTH) procedure. The LED around the RTH Button will blink white to indicate the aircraft is entering RTH mode. The aircraft will then return to the last recorded Home Point. Press this button again to cancel the RTH procedure and regain the control of the aircraft.

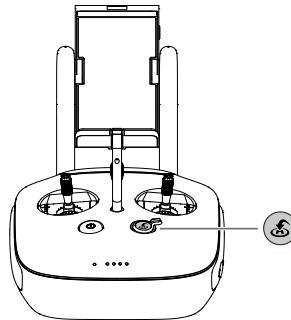

Connecting Mobile Device

Tilt the Mobile Device Holder to the desired position. Press the button on the side of the Mobile Device Holder to release the clamp, and then place your mobile device into the clamp. Adjust the clamp to secure your mobile device. Then connect your mobile device to the remote controller with a USB cable. Plug one end of the cable into your mobile device, and the other end into the USB port on the back of the remote controller.

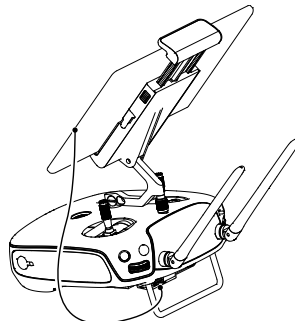

Optimal Transmission Range

The signal transmission between aircraft and remote controller perform best within the range that displayed in the picture shown below:

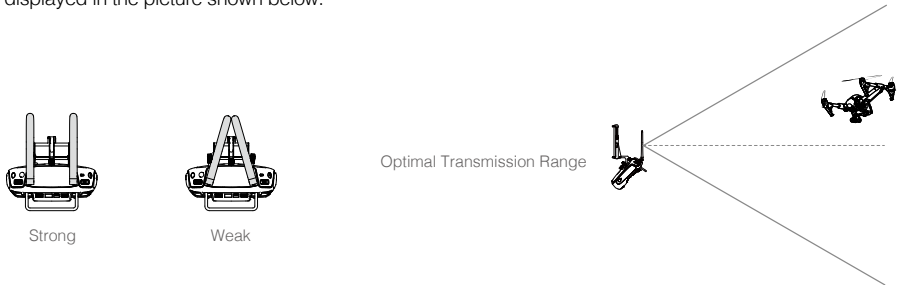

Ensure the aircraft is flying within the optimal transmission range. Adjust the distance and position between the operator and the aircraft to achieve optimal transmission performance.

Dual Remote Controllers Mode

More than one remote controller can connect to the same aircraft in Dual Remote Controller mode. In Dual Controllers mode, the "Master" remote controller operator controls the orientation of the aircraft, while the "Slave" remote controller controls the movement of the gimbal and camera operation. When multiple "slave" remote controllers (max of 6) are connect to the aircraft, only the first connected "slave" remote controller is able to control the gimbal, the remaining "slave" remote controller can view the live feed video from the aircraft and set the camera parameters, but they cannot control the gimbal.

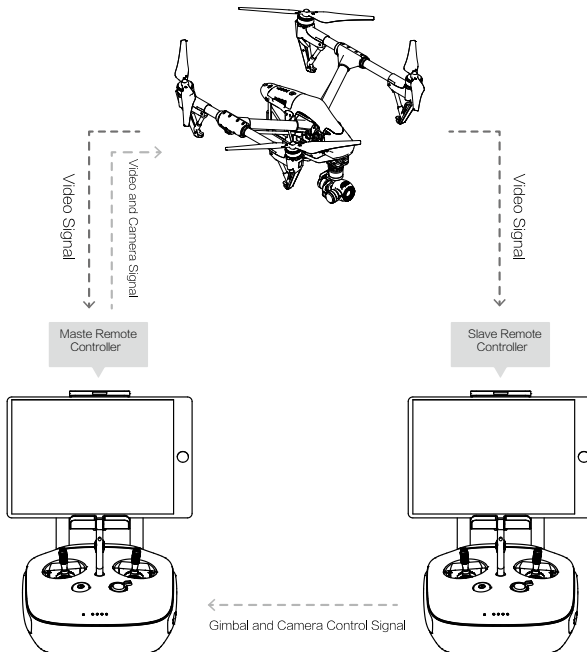

⚠ Use the gimbal dial on the remote controller to control the pitch movement of the camera in the single remote controller mode, however, you cannot control the pan movement of the camera.

Setting Up Dual Remote Controllers Mode

Dual Remote Controllers mode is disabled by default. Users must enable this feature on the “Master” remote controller by through the DJI Pilot app. Follow the steps below for setup:

“Master” Remote Controller:

1. Connect the remote controller to your mobile device and launch the DJI Pilot app.
2. Go to the Camera page, and tap to enter the remote controller settings window.
3. Tap “Set RC Status” to enable Master-and-Slave mode.
4. Select “Master” in the “Set RC Status” section to set the remote controller as “Master” remote controller.

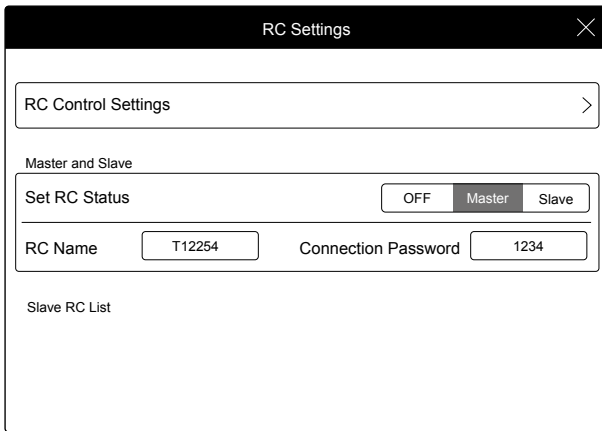

5. Enter the connection password for the “Slave” remote controller.

“Slave” Remote Controller:

1. Tap “Search for Master Controller” to search the “Master” remote controller.

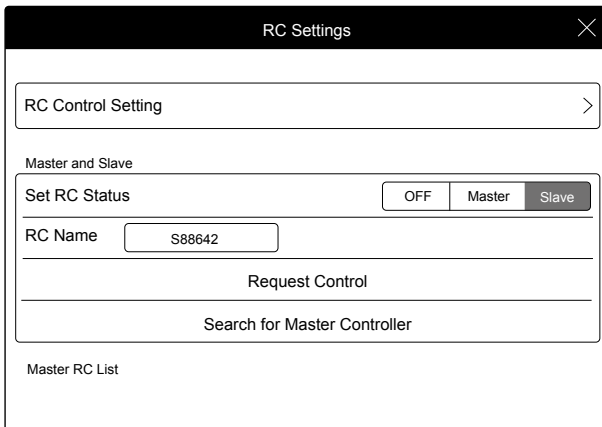

- ⚠ Remote controller cannot link to the aircraft if the remote controller is set as “Slave”. Meanwhile, the “Slave” remote controller cannot control the orientation of the aircraft. Reset the remote controller to “Master” in DJI Pilot app if you wish to link the remote controller to the aircraft.

2. Search the “Master” remote controller in the surrounding area in the “Request Control” section.

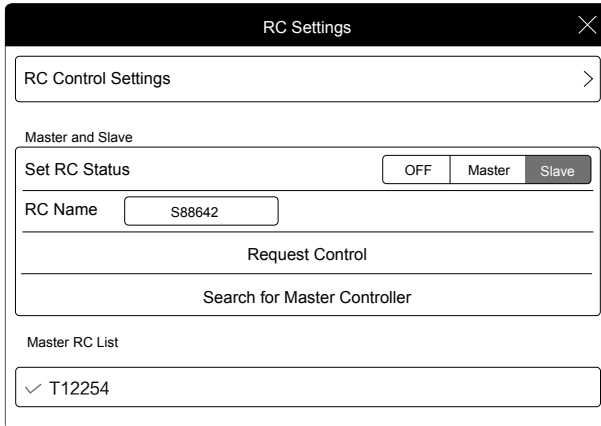

3. Select the “Master” remote controller from the “Master RC List” and input the connection password to connect to the desired “Master” remote controller.

✓ T12254
Master RC List

Connection Password

Remote Controller Status LED

The Status LED reflects connection status between Remote Controller and aircraft. The RTH LED shows the Return to Home status of the aircraft. The table below contains details on these indicators.

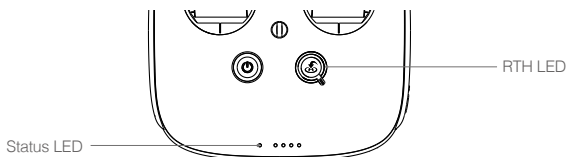

Status LED	Alarm	Remote Controller Status
— Solid Red	chime	The remote controller set as "Master" but it is not connected with the aircraft.
— Solid Green	chime	The remote controller set as "Master" and it is connected with the aircraft.
— Solid Purple	D-D-	The remote controller set as "Slave" but it is not connected with the aircraft.
— Solid Blue	D-D- chime	The remote controller set as "Slave" and it is connected with the aircraft.
..... Slow Blinking Red	D-D-D-.....	Remote controller error.
..... Red and Green/ Red and Yellow Alternate Blinks	None	HD Downlink is disrupted.
RTH LED	Sound	Remote Controller Status.
— Solid White	chime	Aircraft is returning home.
..... Blinking White	D · · ·	Sending Return to Home command to the aircraft.
..... Blinking White	DD · · · ·	Aircraft Return to Home in progress.

The Remote Status Indicator will blink red, sound an alert, when the battery level is critically low.

Linking the Remote Controller

The remote controller is linked to your aircraft before delivery. Linking is only required when using a new remote controller for the first time. Follow these steps to link a new remote controller:

1. Power on the remote controller and connect to the mobile device. Launch DJI Pilot app.
2. Power on the Intelligent Flight Battery.
3. Enter "Camera" view and tap on and then tap "Linking Remote Controller" button as shown below.

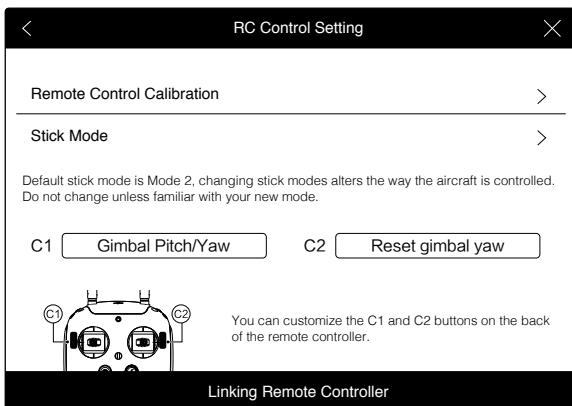

4. The remote controller is ready to link. The Remote Controller Status Indicator blinks blue and "beep" sound is emitted.

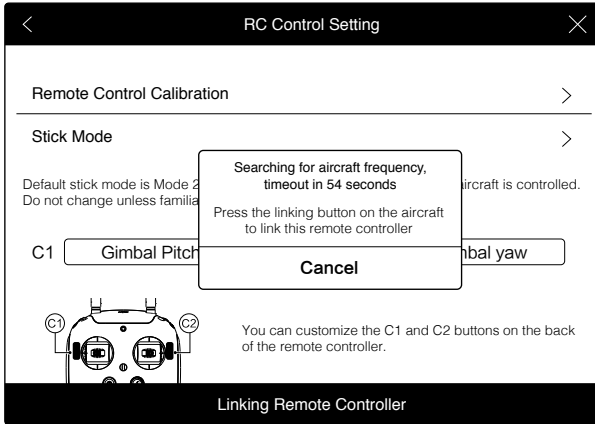

5. Locate the Linking button on the front of the aircraft, as shown in the figure shown below. Press the Linking button to start linking. The Remote Controller Status Indicator will display solid green if Link is succeed.

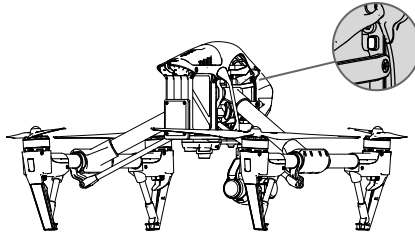

- Remote controller cannot link to the aircraft if the remote controller is set as "Slave". Meanwhile, the "Slave" remote controller cannot control the orientation of the aircraft. Reset the remote controller to "Master" in DJI Pilot app if you wish to link the remote controller to the aircraft.
- Remote controller will disconnect from the linked aircraft if a new remote controller is linked to the same aircraft.

Remote Controller Compliance Version

The remote controller is compliant with both CE and FCC requirements.

Gimbal and Camera

This chapter provides the technical specifications of the camera and explains the working mode of the gimbal.

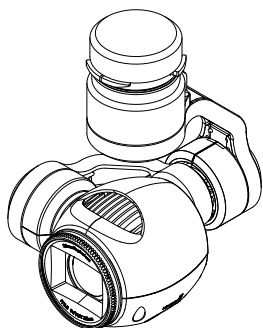

Camera and Gimbal

Camera Profile

The on-board camera supports 4K video capture up to 4096x2160p24 and 12M pixel photos capture by using the 1/2.3 inch CMOS sensor. You may export the video in either MOV or MP4 format for editing. Available picture shooting modes include burst, continuous, and timer mode. A live preview of what the camera is seeing before you shoot videos and pictures is supported through the DJI Pilot App.

Camera Micro-SD Card Slot

To store your photos and videos, plug in the micro-SD card into the slot shown below before powering on the Inspire 1. The Inspire 1 comes with a 16GB micro-SD card and supports up to a 64GB micro-SD card. A UHS-1 type micro-SD card is recommended, because the fast read and write capability of these cards enables you to store high-resolution video data.

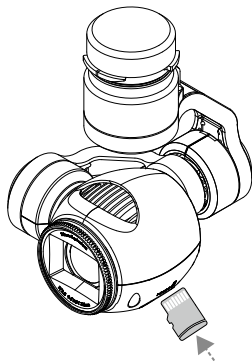

⊘ Do not remove micro-SD card from the Inspire 1 when it is powered on.

Camera Data Port

Power on the Inspire 1 and then connect a USB cable to the Camera Data Port to download photos or videos from the camera to your computer.

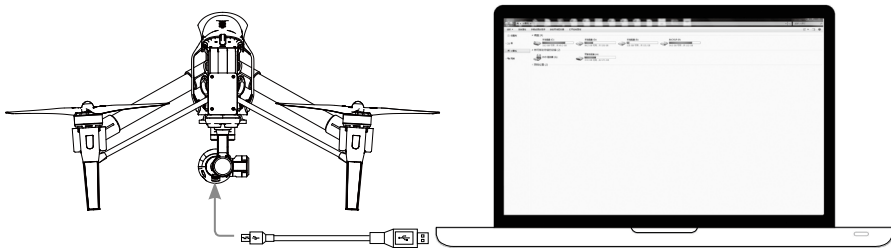

⚠ Power on the aircraft before attempting to download the files.

Camera Operation

Use the Shutter and Record button on the remote controller to shoot the images or the videos through the DJI Pilot app. For more information about how to use these buttons, refer to "Controlling Camera" P25.

ND Filter

Attach an ND filter to the front of the camera to reduce over-exposure and "jello" effect.

Gimbal

Gimbal Profile

The 3-axis Gimbal provides a steady platform for the attached camera, allowing you to capture stabilized images and video. The Gimbal can tilt the camera up to 120 degrees and rotate 360 degrees.

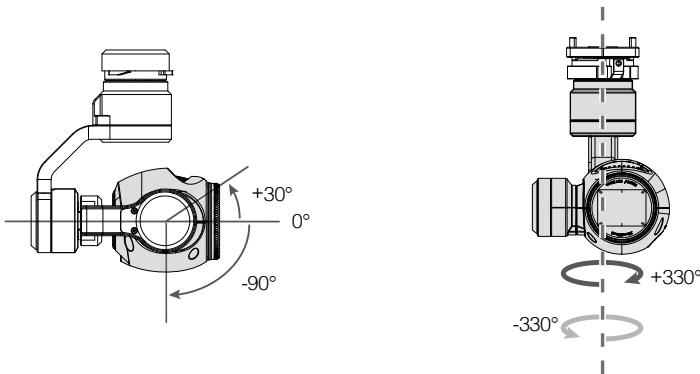

Use the gimbal dial on the remote controller to control pitch movement of the camera by default. Note that you cannot control the pan motion of the camera by default. Enable the "Master-and-Slave" mode and set the remote controller to "Slave" state if you wish to control both the pan and pitch movement of the camera.



Use the gimbal dial on the remote controller to control the pitch movement of the camera in the single remote controller mode, however, you cannot control the pan movement of the camera.

Pan Control

Follow the instructions below to use the gimbal dial to control the pan movement of the gimbal:

1. Power on the aircraft and remote control, launch DJI Pilot app and enter "Camera" page.
2. Tap "RC Control Settings" icon and select either C1 or C2 customizable button as the gimbal pitch/yaw switching button.
3. Select "Gimbal Pitch/Yaw" from the dropdown list.

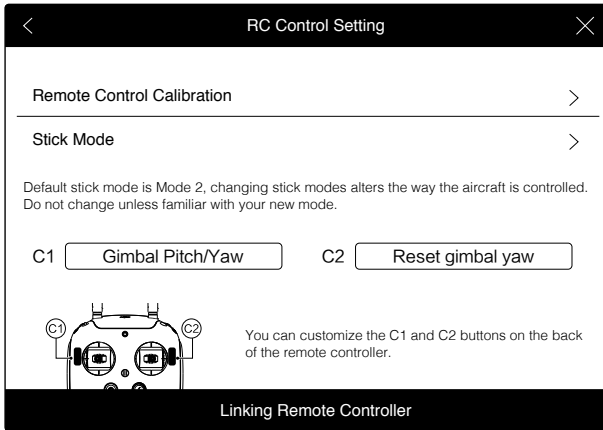

Press C1 or C2 button to switch from pitch mode to yaw mode. You may use the gimbal dial to pan the gimbal under yaw mode. Press C1 or C2 again to exit yaw mode.

Using DJI Pilot App to Control Gimbal

Follow the steps below to use DJI Pilot app to control the gimbal orientation:

1. Launch DJI Pilot app, enter "Camera" page.
2. Tap and press on the screen until a blue circle is shown.
3. Slide to control the gimbal orientation within the "Camera" page as shown below.

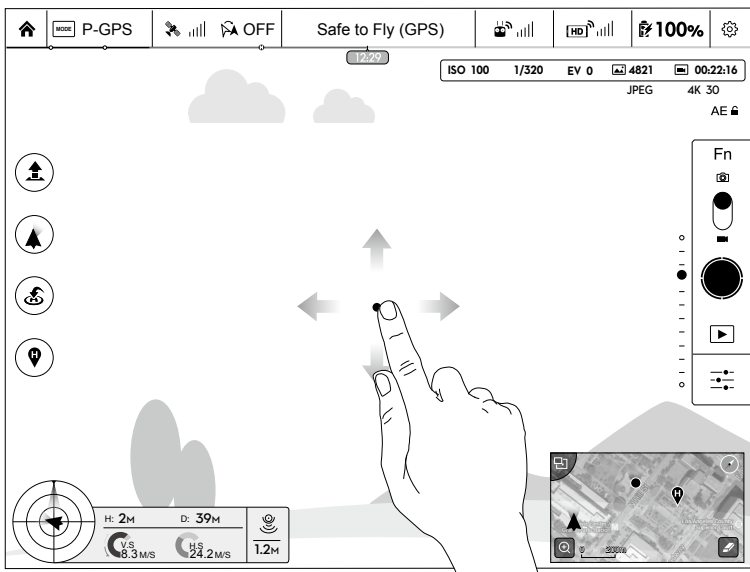

Gimbal Operation Modes

Three Gimbal operation modes are available. Switch between the different operation modes on the Camera page of the DJI Pilot App. Note that your mobile device must be connected to the remote controller for changes to take effect. Refer to the table below for details:

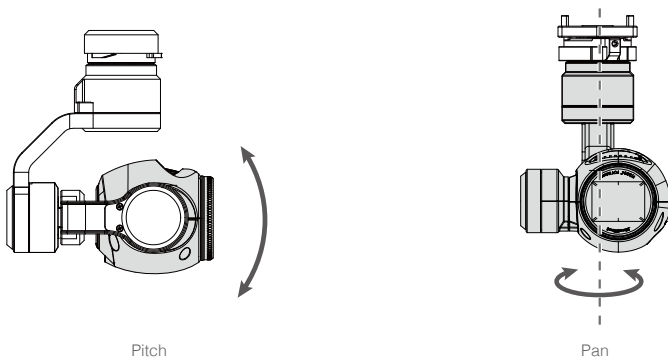

Gimbal and Camera

	Follow Mode	The angle between Gimbal's orientation and aircraft's nose remains constant at all times. One user alone can control the pitch motion of the Gimbal, but a second user is required to control the pan motion using a second remote controller.
	FPV Mode	The Gimbal will lock to the movements of the aircraft to provide a First-Person-View flying experience.
	Free Mode	The Gimbal's motion is independent of the aircraft's orientation. One user alone can control the pitch motion of the Gimbal, but a second user is required to control the pan motion using a second remote controller.
	Re-alignment	Tap to force the Gimbal orientation to re-align with aircraft's orientation by panning from gimbal's current orientation. Pitch angle will remain unchanged during the re-alignment.



- Gimbal motor error may occur in these situations: (1) Gimbal is placed on uneven ground. (2) Gimbal has received an excessive external force, e.g. a collision. Please take off from flat, open ground and protect the gimbal after powering up.
- Flying in heavy fog or cloud may make the gimbal wet, leading to a temporary failure. The gimbal will recover when it dries out.

DJI Pilot App

This chapter describes the four main GUI of the DJI Pilot app.

DJI Pilot App

The DJI Pilot app is a new mobile app designed specifically for the Inspire 1. Use this app to control the gimbal, camera and other features of your flight system. The app also comes with Map, Store a User Center, for configuring your aircraft and sharing your content with friends. It is recommended that you use a tablet for the best experience.

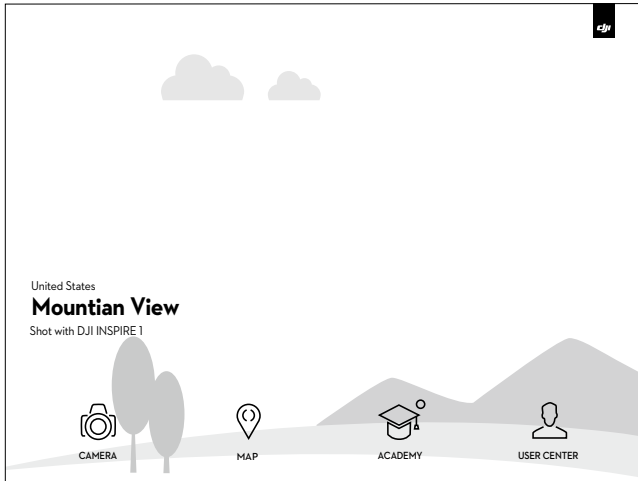

Camera

The Camera page contains a live HD video feed from the Inspire 1's camera. You can also configure various camera parameters from the Camera page.

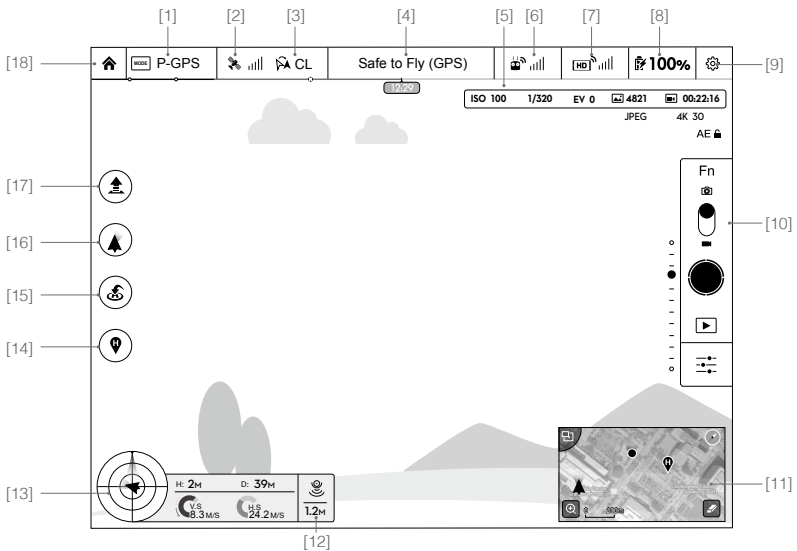

[1] Flight Mode

The text next to this icon indicates the current flight mode.

Tap to enter MC (Main Controller) settings. Modify flight limits, perform compass calibration, and set the gain values on this screen.

[2] GPS Signal Strength

This icon shows the current strength of GPS signals. Green bars indicates adequate GPS strength.

[3] IOC Settings

CL : This icon shows which IOC setting that the aircraft has entered when in F Mode.

Tap to enter IOC setting menu and select Course Lock, Home Lock or Point of Interest Lock.

[4] System Status

This icon shows current aircraft system status, such as GPS signal health.

[5] Battery Level Indicator

The battery level indicator dynamically displays the battery level. The color zones on the battery level indicator represent different battery levels.

[6] Remote Controller Signal

This icon shows the strength of remote controller signal.

[7] HD Video Link Signal Strength

This icon shows the HD video downlink signal strength between the aircraft and the remote controller.

[8] Battery Level

100% This icon shows the current Intelligent Flight Battery level.

Tap to enter battery information menu, set the various battery warning thresholds and view the battery warning history in this page.

[9] General Settings

Tap this icon to enter General Settings page. Select parameter units, reset the camera, enable the quick view feature, adjust the gimbal roll value and toggle flight route display on this page.

[10] Camera Operation Bar**Exposure Lock**

Tap to enable or disable the camera exposure lock.

Function

Tap to adjust camera settings, such as video format and digital filters.

Shutter

Tap this button to take a single photo.

Record

 : Tap once to start recording video, then tap again to stop recording. You can also press the Video Recording Button on the remote controller, which has the same function.

Playback

 : Tap to enter playback page. You can preview photos and videos as soon as they are captured.

Camera Settings and Shooting Mode

 : Tap to enter the Camera Settings page and switch from camera shooting mode from manual to auto.

[11] **Map**

Display the flight path of the current mission. Tap to switch from the Camera GUI to the Map GUI.

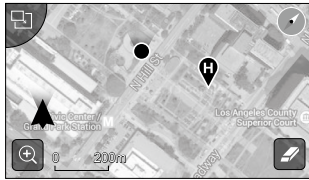

[12] **Vision Positioning**

 : This icon shows the distance between the surface and the Vision Positioning System's sensors.

[13] **Flight Telemetry**

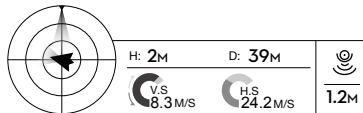

Vision Positioning Status

Icon is highlighted when Vision Positioning is in operation.

Flight attitude is indicated by the flight attitude icon.

- (1) The red arrow shows which direction the aircraft is facing.
- (2) Light blue and dark blue areas indicate pitch.
- (3) Pitching of the boundary between light blue and dark blue area shows roll angle.

[14] **Home Point Settings**

 : Tap this button to reset the current home point. You may choose to set the aircraft take-off location, the remote controller's current position, or the aircraft's current position as the Home Point.



[15] **Return to Home (RTH)**

 : Initiate RTH home procedure. Tap to have the aircraft return to the latest home point.

[16] Gimbal Operation Mode

Refer to "Gimbal Operation Mode" P38 for more information.

[17] Auto Takeoff/Landing

  : Tap to initiate auto takeoff or landing.

[18] Back

 : Tap to return to the main GUI.

Map

User can view the current flight route in a larger map view in this page. You can also perform Auto take-off and Landing in the page. Ensure your mobile device has access to the Internet. Due to the map data required, Wi-Fi connection is recommended. Internet access is required to cache the map, if Wi-Fi is unavailable, mobile data service is required.

Academy

Download user manual, view online videos. Also you can use the flight simulator to practice your flight skills.

User Center

You can sync the picture and videos to the mobile device, view the flight records and check your DJI account status in the User Center. Use the DJI registered account to login to the User Center.

Flight

This chapter describes the flight safety and flight restrictions.

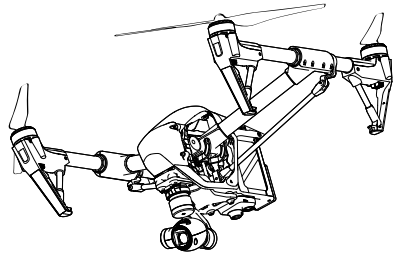

Flight

Once pre-flight preparation is complete, it is recommended to use the flight simulator to learn how to fly safely. Ensure that all flights are carried out in a suitable location.

Flight Environment Requirements

1. Do not use the aircraft in severe weather conditions. These include wind speed exceeding 10m/s , snow, rain and smog.
2. Only fly in open areas. Tall buildings and steel structures may affect the accuracy of the on-board compass and GPS signal.
3. Avoid from obstacles, crowds, high voltage power lines, trees or bodies of water.
4. Minimize electromagnetic interference by not flying in area with high levels of electromagnetism, including mobile phone base stations or radio transmission towers.
5. Aircraft and battery performance is subject to environment factor such as air density and temperature. Be very careful when flying 14700 feet (4500 meters) or more above sea level as battery and aircraft performance may be reduced.
6. The Inspire 1 cannot operate within the polar areas in "P" mode.

Flight Limits and Flight Restriction Area

Flight limits on height and distance can be set. The details of these flight limits are described in the following section.



All unmanned aerial vehicle (UAV) operators should abide by all regulations from such organizations as the ICAO (International Civil Aviation Organization), FAA and their own national airspace regulations. For safety reasons, the flight limits function is enabled by default to help users use this product safely and legally. The flight limits function includes height limits, distance limits and No Fly Zones.

When operating in P Mode, height, distance limits and No Fly Zones work together to manage flight. In A mode only height limits work and flights cannot go higher than 120 meters.

Max Height & Radius Limits

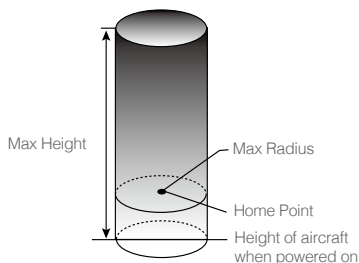
Max Height & Radius limit flying height and distance, and the user may change these settings in the DJI Pilot App. Once complete, your Inspire 1 will fly in a restricted cylinder that is determined by these settings. The tables below show the details of these limits.



GPS Signal Strong  Blinking Green			
	Flight Limits	DJI Pilot App	Aircraft Status Indicator
Max Height	Flight altitude must be under the set height.	Warning: Height limit reached.	None.
Max Radius	Flight distance must be within the max radius.	Warning: Distance limit reached.	Rapid red flashing  when close to the max radius limit.

GPS Signal Weak  Blinking Yellow			
	Flight Limits	DJI Pilot App	Aircraft Status Indicator
Max Height	Flight height restricted to 120m and under.	Warning: Height limit reached.	None.
Max Radius	No limits		

-  • If you fly out of the limit, you can still control the Inspire 1, but cannot fly it further.
 • If the Inspire 1 flies out of the max radius in Ready to Fly (non-GPS) mode, it will fly back within range automatically.

Flight Restriction of Restricted Areas

Restricted areas include airports worldwide. All restricted areas are listed on the DJI official website at <http://www.dji.com/fly-safe/category-mc>. Restricted areas are divided into category A and category B. Category A areas cover major international airport such as LAX and Heathrow, while category B areas includes smaller airports.

Category A Safety Zone



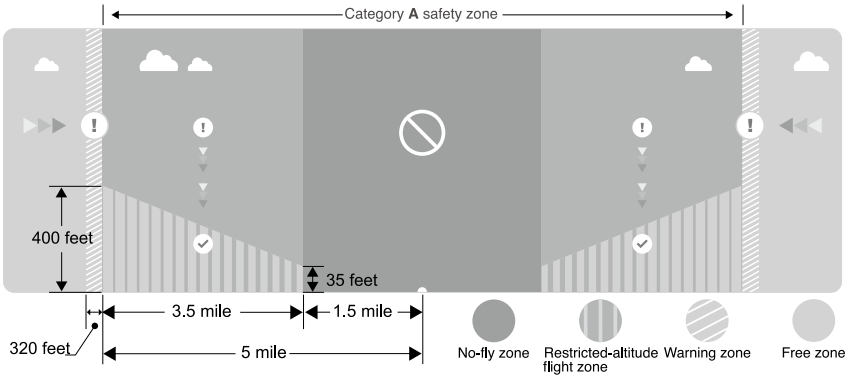



- (1) The category A "safety zone" is comprised of a small "no-fly zone" and a range of "restricted-altitude zones". Flight is prevented in the "no-fly zone" but can continue with height restrictions in the restricted-altitude zone.
- (2) 1.5 miles (2.4 km) around a designated safety zone is a no-fly zone, inside which takeoff is prevented.
- (3) 1.5 miles (2.4 km) to 5 miles (8 km) around restricted areas are altitude restricted, with maximum altitude going from 35 feet (10.5 m) at 1.5 miles (2.4 km) to 400 feet (120 m) at 5 miles (8 km).
- (4) A "warning zone" has been set around the safety zone. When you fly within 320 feet (100m) of the safety zone, a warning message will appear on the DJI Pilot App.

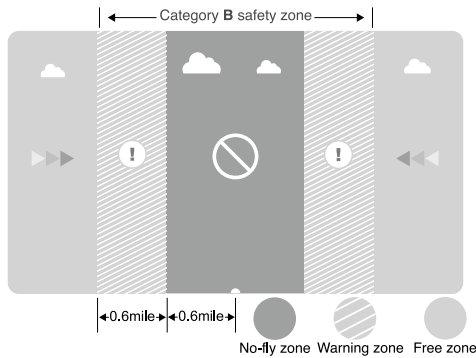



Category B Safety Zone

- (1) Category B "safety zone" is comprised of a "no-fly zone" and a "warning zone".
- (2) 0.6 miles (1 km) around the safety zone is a designated "no-fly zone".
- (3) A "warning zone" has been set around the safety zone. When you fly within 0.6 miles (1km) of this zone, a warning will appear on the DJI Pilot App.



GPS Signal Strong  Blinking Green			
Zone	Restriction	DJI Pilot App Prompt	Aircraft Status Indicator
No-fly Zone 	Motors will not start.	Warning: You are in a No-fly zone. Take off prohibited.	 Red flashing
	If the aircraft enters the restricted area in A mode but P mode activates the aircraft will automatically descend to land then stop its motors after landing.	Warning: You are in a No-fly zone, automatic landing has begun. (If you are within 1.5 mile radius)	
Restricted-altitude flight zone 	If the aircraft enters the restricted area in A mode but P mode activates, it will descend to a safe altitude and hover 15 feet below the safe altitude.	Warning: You are in a restricted zone. Descending to safe altitude. (If you are between the range of 1.5 mile and 5 mile radius) Warning: You are in a restricted zone. Max flight height restricted to between 10.5m and 120m. Fly Cautiously.	
Warning zone 	No flight restriction applies, but there will be warning message.	Warning: You are approaching a restricted zone, Fly Cautiously.	
Free zone 	No restrictions.	None.	

 Semi-automatic descent: All stick commands are available except the throttle stick command during the descent and landing process. Motors will stop automatically after landing.

-  • When flying in the safety zone, aircraft status indicator will blink red quickly and continue for 3 seconds, then switch to indicate current flying status and continue for 5 seconds at which point it will switch back to red blinking.
- For safety reasons, please do not fly close to airports, highways, railway stations, railway lines, city centers and other special areas. Try to ensure the aircraft is visible.

Preflight Checklist

1. Remote controller, aircraft battery, and mobile device are fully charged.
2. Propellers are mounted correctly and firmly.
3. Micro-SD card has been inserted if necessary.
4. Gimbal is functioning as normal.
5. Motors can start and are functioning as normal.
6. DJI Pilot app connected to the aircraft.

Calibrating the Compass

IMPORTANT: Make sure to calibrate the compass in every new flight location. The compass is very sensitive to electromagnetic interference, which can cause abnormal compass data leading to poor flight performance or even failure. Regular calibration is required for optimum performance.

- ⊗ • DO NOT calibrate your compass where there is a chance of strong magnetic interference, such as magnetite, parking structures, and steel reinforcements underground.
- DO NOT carry ferromagnetic materials with you during calibration such as keys or cellular phones.
- DO NOT calibrate beside massive metal objects.

Calibration Procedures

Choose an open space to carry out the following procedures.

1. Ensure the compass is calibrated. If you did not calibrate the compass in the Checklist, or if you have changed your position since last calibrating it, tap "MODE" in the app and select "Compass Calibration" to calibrate the compass. Then follow the on-screen instructions.
2. Hold and rotate the aircraft horizontally 360 degrees, and the Aircraft Status Indicator will display a solid green light.

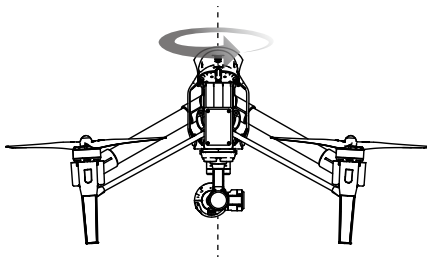

3. Hold the aircraft vertically with nose pointing downward, and rotate it 360 degrees around the center axis. Recalibrate the compass if the Aircraft Status Indicator show solid red.

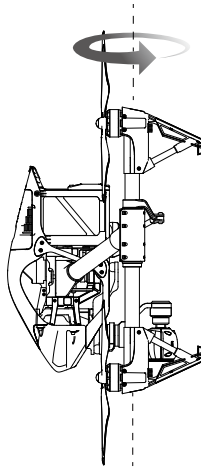

 If the Aircraft Status Indicator blinks red and yellow after the calibration, move your aircraft to a different location to carry out compass calibration.

 Calibrate the compass before each flight. Launch DJI Pilot App, follow the on-screen instruction to calibrate the compass.

When to Recalibrate

1. When compass data is abnormal, and the Aircraft Status Indicator is blinking red and yellow.
2. When flying in a new location, or a location that is different from your last flight.
3. When the mechanical structure of the Inspire 1 has changed, i.e. changed mounting position of the compass.
4. When severe drifting occurs in flight, i.e. the Inspire 1 does not fly in straight lines.

Auto Take-off and Auto Landing

Auto Take-off

Use auto take-off to take off your aircraft automatically if the Aircraft Status Indicator displays blinking green. Follow the steps below to use auto take-off:

1. Launch DJI Pilot app, enter "Camera" page.
2. Ensure the aircraft is in "P" mode.
3. Go through the pre-flight checklist.
4. Tap "▲", and confirm flight condition. Slide to confirm and take-off.
5. Aircraft takes off and hovers at 1.5 meters above ground.

Auto-Landing

Use auto-landing to land your aircraft automatically if the Aircraft Status Indicator displays blinking green. Follow the steps below to use auto-landing:

1. Ensure the aircraft is in "P" mode.
2. Check the landing area condition before tapping "↓", to perform landing.
3. Aircraft lowers the landing gear and proceed to land automatically.

Starting/Stopping the Motors

Starting Motors

The Combination Stick Command (CSC) listed below are used to start the motors instead of simply pushing the stick up. Ensure that you perform the CSC in one motion.





Stopping Motors

There are two methods to stop the motors.

Method 1: When the Inspire 1 has landed, push the throttle down ①, then conduct CSC ②. Motors will stop immediately. Release both sticks once motors stop.

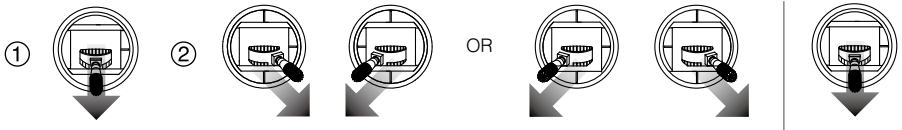
Method 2: When the aircraft has landed, push the throttle down and hold. The motors will stop after 3 seconds.



 Do not perform CSC when aircraft is in midair, otherwise the motors will be stopped.

Flight Test

Take off/Landing Procedures

1. Place the aircraft on open, flat ground with battery indicators facing towards you.
2. Power on the remote controller and your mobile device, then the Intelligent Flight Battery.
3. Launch the DJI Pilot App and enter the Camera page.
4. Wait until the Aircraft Indicator blinks green. This means the Home Point is recorded and it is safe to fly now. If it flashes yellow, it means Home Point is not recorded, and you should not take off.
5. Push the throttle up slowly to take off or using Auto Take-off to take off.
6. Shoot photos and videos using the DJI Pilot app.
7. To land, hover over a level surface and gently pull down on the throttle slowly to descend.
8. After landing, execute the CSC command or hold the throttle at its lowest position for 3 seconds or more until the motors stop.
9. Turn off the Intelligent Flight Battery first, followed by the Remote Controller.



- When the Aircraft Status Indicator blinks yellow rapidly during flight, the aircraft has entered Failsafe mode.
 - A low battery level warning is indicated by the Aircraft Status Indicator blinking red slowly or rapidly during flight.
 - Watch video tutorials about flight for more flight information.
-

Video Suggestions and Tips

1. Work through the checklist before each flight.
2. Select desired gimbal working mode in the DJI Pilot app.
3. Aim to shoot when flying in P mode only.
4. Always fly in good weather, such as sunny or windless days.
5. Change camera settings to suit you. These include photo format and exposure compensation.
6. Perform flight tests to establish flight routes and scenes.
7. Push the sticks gently to make aircraft movements stable and smooth.

FAQ

Troubleshooting (FAQ)

1. How can I put a GoPro camera on the Inspire 1?

The Inspire 1 does not currently support GoPro attachments. The gimbal is designed to hold DJI cameras only.

2. When will ground station functionality be available?

The Inspire 1 does not currently support ground station. Ground station will be available with future firmware updates.

3. Is the camera's exposure automatic?

The exposure can be set to Auto, for automatic changes, or Manual, if you wish to use a specific setting.

4. Can I see the size of images through the app?

Yes, you can preview image or video sizes through the DJI Pilot app.

5. How much weight can the Inspire 1 carry without its included camera?

We do not recommend flying with any payload other than the included DJI gimbal and camera.

6. Do you have an LCD monitor available for the Inspire 1?

No, DJI does not sell LCD or HD monitors for the Inspire 1. However, you can output the live streaming video to a compatible monitor or mobile device of your own.

7. How long does it take to charge the battery? Does it come with a charger?

Yes, all Inspire 1 units come with standard TB47 charger.

With the standard TB47 100W charger, it takes 85min to fully charge a 4500mAh battery.

8. Are the two remote controllers the same? Should I setup the remote controllers in the app or somewhere else to control the camera and aircraft separately?

The two remote controllers are physically identical. You can set the remote controllers to either "Master" or "Slave" through the DJI Pilot app if you wish to use dual controller mode.

9. Where can I find info on the simulation application that plugs into the trainer port? Can you suggest a simulation program?

There is no trainer port on the remote controller for the Inspire 1.

10. Can the mobile device holder be used on the Phantom 2 series remote controller?

No, it cannot. The mobile device holder can only be used with the Inspire 1 remote.

11. Does the Inspire 1 have a SD card included?

The Inspire 1 comes with a 16GB micro-SD card. It supports SD cards up to 64GB.

12. Can I upgrade and buy a second remote controller if I only buy a single remote controller now?

Yes.

13. How big is the Inspire 1?

Its length x height x width dimensions without the propellers attached are 44 x 30 x 45cm (17.3 x 11.8 x 17.7in).

14. What flight controller does the Inspire 1 use?

The Inspire 1 uses its own new flight controller.

15. Which motors and propellers does the Inspire 1 come with?

The Inspire 1 uses 3510 motors and 1345 propellers.

16. Aircraft frame arm joints appear loosen, is that normal?

The space of the joints shown in the below figure is normal and it will not affect the performance of aircraft, do not adjust the position of the screws on your own.

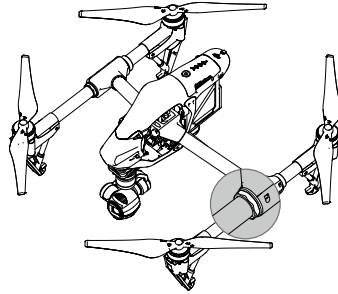

17. Failed to complete self-check?

Place the aircraft on the flat surface before powering on. Do not move the aircraft during the self-check.

Appendix

Appendix

Specifications

Aircraft

Model	T600
Weight (Battery Included)	2935 g
Hovering Accuracy (P Mode)	Vertical: 0.5 m Horizontal: 2.5 m
Max Angular Velocity	Pitch: 300°/s Yaw: 150°/s
Max Tilt Angle	35°
Max Ascent Speed	5 m/s
Max Descent Speed	4 m/s
Max Speed	22 m/s (ATTI mode, no wind)
Max Flight Altitude	4500 m
Max Wind Speed Resistance	10 m/s
Max Flight Time	Approximately 18 minutes
Motor Model	DJI 3510
Propeller Model	DJI 1345
Indoor Hovering	Enabled by default
Operating Temperature Range	-10° to 40° C
Diagonal Distance	559 to 581 mm
Dimensions	438x451x301 mm

Gimbal

Model	ZENMUSE X3
Output Power (With Camera)	Static: 9 W; In Motion: 11 W
Operating Current	Station: 750 mA; Motion: 900 mA
Angular Vibration Range	±0.03°
Mounting	Detachable
Controllable Range	Pitch: -90° to +30° Pan: ±320°
Mechanical Range	Pitch: -125° to +45° Pan: ±330°
Max Controllable Speed	Pitch: 120°/s Pan: 180°/s

Camera	
Name	X3
Model	FC350
Total Pixels	12.76M
Effective Pixels	12.4M
Image Max Size	4000x3000
ISO Range	100-3200 (video) 100-1600 (photo)
Electronic Shutter Speed	8 s to 1/8000 s
FOV (Field Of View)	94°
CMOS	Sony EXMOR 1/2.3"
Lens	20mm (35mm format equivalent) f/2.8 focus at ∞) 9 Elements in 9 groups Anti-distortion
Still Photography Modes	Single shoot Burst shooting: 3/5/7 frames Auto Exposure Bracketing (AEB): 3/5 bracketed frames at 0.7EV Bias Time-lapse
Video Recording Modes	UHD (4K): 4096x2160p24/25, 3840x2160p24/25/30 FHD: 1920x1080p24/25/30/48/50/60 HD: 1280x720p24/25/30/48/50/60
Max Bitrate Of Video Storage	60 Mbps
Supported File Formats	FAT32/exFAT Photo: JPEG, DNG Video: MP4/MOV (MPEG-4 AVC/H.264)
Supported SD Card Types	Micro SD Max capacity: 64 GB. Class 10 or UHS-1 rating required.
Operating Temperature Range	0° to 40° C
Remote Controller	
Name	C1
Operating Frequency	922.7MHz~927.7 MHz (Japan Only) 5.725~5.825 GHz;2.400~2.483 GHz
Transmitting Distance	2 km (Outdoor And Unobstructed)
EIRP	10dBm@900m, 13dBm@5.8G, 20dBm@2.4G
Video Output Port	USB, Mini-HDMI
Power Supply	Built-in battery
Charging	DJI charger
Dual User Capability	Host-and-Slave connection

Mobile Device Holder	Tablet or Smart Phone
Output Power	9 W
Operating Temperature Range	-10° to 40° C
Storage Temperature Range	Less than 3 months: -20° to 45° C More than 3 months: 22° to 28° C
Charging Temperature Range	0-40° C
Battery	6000 mAh LiPo 2S
Charger	
Model	A14-100P1A
Voltage	26.3 V
Rated Power	100 W
Battery (Standard)	
Name	Intelligent Flight Battery
Model	TB47
Capacity	4500 mAh
Voltage	22.2 V
Battery Type	LiPo 6S High voltage battery
Energy	99.9 Wh
Net Weight	570 g
Operating Temperature Range	-10° to 40° C
Storage Temperature Range	Less than 3 months: -20° to 45° C More than 3 months: 22° C to 28° C
Charging Temperature Range	0° to 40° C
Max Charging Power	180 W
Battery (Optional)	
Name	Intelligent Flight Battery
Model	TB48
Capacity	5700 mAh
Voltage	22.8 V
Battery Type	LiPo 6S
Energy	129.96 Wh
Net Weight	670 g
Operating Temperature Range	-10 to 40° C
Storage Temperature Range	Less than 3 months: -20 to 45° C More than 3 months: 22° to 28° C
Charging Temperature Range	0° to 40° C

Max Charging Power	180 W
--------------------	-------

Vision Positioning

Velocity Range	Below 8 m/s (2 m above ground)
----------------	--------------------------------

Altitude Range	5-500 cm
----------------	----------

Operating Environment	Brightly lit (lux > 15) patterned surfaces
-----------------------	--

Operating Range	0-250 cm
-----------------	----------

DJI Pilot App

Mobile Device System Requirements	iOS version 7.1 or later; Android version 4.1.2 or later
-----------------------------------	--

Supported Mobile Devices	* iPhone 6 Plus, iPhone 6, iPhone 5S, iPad Air 2, iPad Mini 3, iPad Air, iPad Mini 2, iPad 4;* Samsung Note 3, Samsung S5, Sony Z3 EXPERIA;* Note: It is recommended that you use a tablet for the best experience
--------------------------	--

Intelligent Orientation Control (IOC)



IOC allows users to lock the orientation of aircraft in different fashions. There are three working modes for IOC and you may select the desired IOC modes from the DJI Pilot app. IOC only works under F mode, and user must toggle the flight mode switch to "F" mode to activate IOC. Refer to the table below:

Course Lock (CL)	Its forward direction is pointing to the nose direction when recording, which is fixed until you re-record it or exit from CL.
Home Lock (HL)*	Record a Home Point (HP), and push Pitch stick to control the aircraft far from or near to the HP.
Point of Interest (POI)*	Point of Interest. Record a point of interest (POI), the aircraft can circle around the POI, and the nose always points to the POI.

 *Home Lock and Point of Interest feature are coming soon.

Prerequisites of IOC

Use the IOC feature under the following condition:

Modes IOC	GPS enabled	GPS	Flight Distance Limits
Course Lock	No	None	None
Home Lock	Yes		Aircraft $\leftarrow \geq 10m \rightarrow$ Home Point
POI	Yes		Aircraft $\leftarrow 5m-500m \rightarrow$ Point of Interest

Using IOC

Enable the IOC feature by tapping "Enable IOC" in the setting page of the DJI Pilot app. Toggle the Flight Mode Switch to "F" mode and follow the on-screen instruction to use IOC feature.

How to Update Firmware

Follow the steps below to upgrade your Inspire 1's firmware, including the firmware for the remote controller and battery.

Updating the Aircraft Firmware

Step 1- Check Battery and SD Card Capacity

Ensure the Intelligent Flight Battery and Remote Controller have at least 50% power and there is at least 100MB of free space on the SD card.

Step 2- Prepare the Firmware Update Package

1. Download the firmware update package from the official DJI website (<http://www.dji.com/product/inspire-1>).
2. Insert the SD into your PC. Extract the all downloaded files into the root directory of the SD card. Remove the SD card from your PC and insert it into the SD card slot on the Inspire 1 camera.

Step 3- Update the Aircraft

1. Connect your mobile device to the remote controller, power on the remote controller, and launch the DJI Pilot app to obtain information about firmware update progress. Confirm you wish to update within the app to continue. Note the upgrade will begin automatically after power cycling the aircraft if the DJI Pilot app is not launched.
2. It will take approximately 25 minutes to complete the firmware update. During the upgrade process, DJI Pilot app will display update progress and gimbal will sound a fast beeping sound(D-D-D-D). A message windows of "Upgrade Completed, Aircraft will restart in 5 seconds" will prompt in DJI Pilot app and gimbal will sound a slow beeping sound (D-DD) to indicate the update is complete, aircraft will then restart automnaly. Note that user will need to manually power cycle the aircraft if DJI Pilot app is not launched prior to the upgrade.
3. Try update again if gimbal sounds a long beeping sound.

Updating the Remote Controller Firmware

Step 1- Check Battery

The remote controller firmware is included in the aircraft firmware update package. Use the same update file that is downloaded from the official DJI website. Ensure the remote controller's remaining battery level is at least 50%.

Step 2- Prepare the Firmware Update Package

1. Extract all downloaded files into the root directory of an SD card or USB thumb drive.
2. With the remote controller powered off, insert the SD card into a SD card reader and plug the reader into the USB port on the remote. Or if using a USB thumb drive, plug it directly into the remote's USB port. If you do not have a SD card reader or USB thumb drive, you may insert the SD card into the gimbal and connect the gimbal to the remote controller with a USB cable.

Step 3- Update the Remote Controller

1. Power on the remote controller and wait 60 seconds until the upgrade begins. Do not power off the remote controller during the update.
2. It will take approximately 10 minutes to complete the firmware update. The Inspire 1's camera will emit a beeping sound and the Status LED on the remote controller will show a solid blue light to indicate

the update is in progress. The Status LED on the remote controller will show a solid green light and the beeping sound will stop when the upgrade is complete. The Status LED on the remote controller will show a solid red light if the upgrade fails. In this case, try the update again.

Updating Intelligent Flight Battery Firmware

The Intelligent Flight Battery's firmware is updated during the aircraft firmware update process. Simply keep the update package files on your SD card and update the Intelligent Flight Battery firmware if prompted in the DJI Pilot app. The update will start automatically if the aircraft is not connected to the DJI Pilot app after power cycling the aircraft.



- Do not perform firmware update while the aircraft is still flying in the air. Only carry out firmware update when the aircraft is landed.
- Be sure to update the remote controller's firmware to the latest version after you upgrade the aircraft's firmware.
- The remote controller may become unlinked from the aircraft after updating. Re-link the remote controller and aircraft.
- Confirm the update results according to the gimbal sounds. It is normal for the aircraft to sound or the LED to blink during the update process. The on-screen rate of progress is for reference only.
- Ensure there is only one firmware package file stored on your SD card.
- Only storage devices that are formatted for FAT32 and exFAT file systems are supported for aircraft and remote controller firmware updates.
- Delete any automatically generated txt files (xxx_GS.TXT) in the SD card when updating multiple remote controllers.

FCC Compliance

FCC Compliance

This device complies with part 15 of the FCC Rules. Operation is subject to the following two conditions:

- (1) This device may not cause harmful interference, and
- (2) This device must accept any interference received, including interference that may cause undesired operation.

Changes or modifications not expressly roved by the party responsible for compliance could void the user's authority to operate the equipment.

Compliance Information

FCC Warning Message

Any Changes or modifications not expressly roved by the party responsible for compliance could void the user's authority to operate the equipment.

This device complies with part 15 of the FCC Rules. Operation is subject to the following two conditions:

- (1) This device may not cause harmful interference, and
- (2) this device must accept any interference received, including interference that may cause undesired operation.

FCC Radiation Exposure Statement:

This equipment complies with FCC radiation exposure limits set forth for an uncontrolled environment. This equipment should be installed and operated with minimum distance 20cm between the radiator&

your body. This transmitter must not be co-located or operating in conjunction with any other antenna or transmitter.

Note: This equipment has been tested and found to comply with the limits for a Class B digital device, pursuant to part 15 of the FCC Rules. These limits are designed to provide reasonable protection against harmful interference in a residential installation. This equipment generates uses and can radiate radio frequency energy and, if not installed and used in accordance with the instructions, may cause harmful interference to radio communications. However, there is no guarantee that interference will not occur in a particular installation. If this equipment does cause harmful interference to radio or television reception, which can be determined by turning the equipment off and on, the user is encouraged to try to correct the interference by one or more of the following measures:

- Reorient or relocate the receiving antenna.
- Increase the separation between the equipment and receiver.
- Connect the equipment into an outlet on a circuit different from that to which the receiver is connected.
- Consult the dealer or an experienced radio/TV technician for help.

IC RSS warning

This device complies with Industry Canada licence-exempt RSS standard (s). Operation is subject to the following two conditions: (1) this device may not cause interference, and (2) this device must accept any interference, including interference that may cause undesired operation of the device.

Le présent ariel est conforme aux CNR d'Industrie Canada licables aux aereils radio exempts de licence.

L'exploitation est autorisée aux deux conditions suivantes:

- (1) l'areil ne doit pas produire de brouillage, et
- (2) l'utilisateur de l'areil doit accepter tout brouillage radioélectrique subi, même si le brouillage est susceptible d'en compromettre le fonctionnement.

IC Radiation Exposure Statement:

This equipment complies with IC RF radiation exposure limits set forth for an uncontrolled environment. This transmitter must not be co-located or operating in conjunction with any other antenna or transmitter. This equipment should be installed and operated with minimum distance 20cm between the radiator & your body.

Any Changes or modifications not expressly roved by the party responsible for compliance could void the user's authority to operate the equipment.

KCC Warning Message

“해당 무선설비는 운용 중 전파혼신 가능성이 있으므로 인명안전과 관련된 서비스는 할 수 없습니다.”
 “해당 무선설비는 운용 중 전파혼신 가능성이 있음”

NCC Warning Message

低功率電波輻射性電機管理辦法

第十二條經型式認證合格之低功率射頻電機，非經許可，公司、商號或使用者均不得擅自變更頻率、加大功率或變更原設計之特性及功能。

第十四條低功率射頻電機之使用不得影響飛航安全及干擾合法通信；經發現有干擾現象時，應改善至無干擾時方得繼續使用。前項合法通信，指依電信法規定作業之無線電通信。低功率射頻電機須忍受合法通信或工業、科學及醫療用電波輻射性電機設備之干擾。

The content is subject to change.

Download the latest version from

www.dji.com/support

